



UNIVERSIDAD DISTRITAL
FRANCISCO JOSÉ DE CALDAS

VISIÓN ELECTRÓNICA

Algo más que un estado sólido

<https://doi.org/10.14483/issn.2248-4728>



VISIÓN ELECTRÓNICA

A CASE-STUDY VISION

Semigar greenhouse automation

Automatización del vivero Semigar

**Edgar Mauricio González-Clavijo¹, Juan Camilo Contreras-Niño²,
Hermes Javier Eslava-Blanco³**

Abstract

The following article describes the development and implementation of an automatic watering system by activating parameters of humidity sensors according to the pH of the earth and rain with visualization in PC, an assistance control obtained by a biometric sensor archiving in a database and thus be able to register employees and control the assistance of them through a web page where you can obtain detailed reports of their attendance in the month. In the same way, a prototype is made where the operation of these in closed spaces is evidenced, obtaining detailed information regarding the sensors, besides the registration and obtaining of personnel in the biometric sensor.

The automation system consists of a humidity sensor and a rain sensor that are responsible for obtaining the values of the environment, then the information obtained from the sensors is sent to a computer to be able to visualize it, and in this way, the microcontroller will be responsible

¹ Electronics Technology, Universidad Distrital Francisco José de Caldas, Colombia. Email: edmgonzalezcl@correo.udistrital.edu.co ORCID: <https://orcid.org/0000-0003-1912-7426>

² Electronics Technology, Universidad Distrital Francisco José de Caldas, Colombia. Email: jcontrerasn@correo.udistrital.edu.co ORCID: <https://orcid.org/0000-0002-8670-3289>

³ MSc. in Telecommunications Engineering, Universidad Nacional de Colombia. PhD. in Systems and Computer Engineering, Universidad Nacional de Colombia. Universidad Distrital Francisco José de Caldas. Email: hjeslavab@udistrital.edu.co ORCID: <https://orcid.org/0000-0002-2630-0023>

for activating the valves that allow the flow of water for irrigation and the relevant visualization of the land.

The second part is an attendance control that is composed of a biometric sensor that detects the fingerprints of the staff and is responsible for sending it to a server for storage, the server is based on the Raspberry Pi 3 where you will get fingerprints, names, and other pertinent information to obtain a report that can be downloaded on a web page only for the administrators of the place.

Keywords: Automation, pH, Raspberry Pi 3, sensor, server, web platform, wireless communication.

Resumen

En el siguiente artículo se describe el desarrollo e implementación de un sistema de riego automático por activación de parámetros de sensores de humedad según el pH de la tierra y lluvia con visualización en pc, un control de asistencia obtenido por un sensor biométrico archivándose en una base de datos y así poder registrar a los empleados y controlar la asistencia de ellos mediante una página web donde se puede obtener informes detallados de su asistencia en el mes. De igual manera se realiza un prototipo donde se evidencia el funcionamiento de estos en espacios cerrados, obteniendo información detallada en cuanto a los sensores, además del registro y obtención de personal en el sensor biométrico.

El sistema de automatización se compone de un sensor de humedad y un sensor de lluvia que son los encargados de obtener los valores del ambiente, seguidamente se envía la información obtenida de los sensores a un ordenador con el fin de poderla visualizar, ya de esta manera el microcontrolador se encargara de activar las válvulas que permiten el flujo del agua para riego y la visualización pertinente del terreno.

La segunda parte es un control de asistencia que se compone de un sensor biométrico el cual detecta las huellas del personal y está encargado de enviarlo a un servidor para su almacenamiento, el servidor está en base a la Raspberry Pi 3 donde se obtendrá las huellas, nombres y demás datos pertinentes para la obtención de un informe que se podrá descargar en una página web únicamente para los administradores del lugar.

Palabras clave: Automatización, pH, Raspberry Pi 3, sensor, servidor, plataforma web, comunicación inalámbrica.

1. Introduction

Currently, the state of rural work areas in Colombia are very low tech, under the supervision of staff and very little space which has deteriorated the condition of the same and lowered the quality of their work by abandonment, neglect, or similar situations therefore the fact of including technological means in these natural spaces has been taken as an option to improve their production, quality, and work area to optimize their results, taking advantage of the current rise in the practice and use of home automation as a great option in these cases, thus leading to the formation and development of this model of supervision and automation of a rural work environment.

A review of the state of the art is presented for an automatic irrigation system, with computer communication and obtaining values from biometric sensors, server operation in the embedded system Raspberry Pi 3, defining basic concepts to recognize its scope in the rural work environment, analysis is made from moisture sensors to distinctions between web pages with private and public access. The server is a LAMP system (Linux, Apache, MySQL, and PhpMyAdmin) an environment that allows the Raspberry Pi 3 to develop and manage pages and databases to correctly run the planned environment for obtaining values through the

biometric sensor and the display of detailed reports of the staff appreciating the time of arrival and departure from the work area.

2. State of the art

2.1. State

Agriculture has always been the key factor by which human civilization began, obtaining food through the use of soil has been the greatest invention because it was for this reason that humanity went from being nomadic to sedentary and began to form the first civilizations. Nowadays, it is still a fundamental basis for every nation and many of them can make the most of the variables of the environment to obtain a production far above other nations, variables such as soil pH, air humidity, luminosity of the environment, rain and even the evo-transpiration of the plants to take advantage of the nutrients. The pH (potential of hydrogen) is the measure of the degree of acidity or alkalinity of the soil. A pH of 7.0 indicates neutrality, but as this value decreases the soil becomes more acidic, so a pH of 6.0 is ten times more acidic than a pH of 7.0. The practical significance of pH in terms of soil acidity is that it significantly affects the availability and assimilation of nutrients and exerts a strong influence on soil structure [1].

Figure 1. Nutrient availability for soil pH [1].

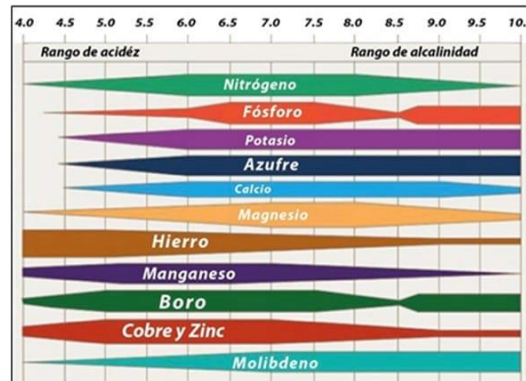

2.2. Water distribution

A factor too important is the amount and distribution of water so the agronomist Daniel Ortiz Gomez writes that water is fundamental to agriculture, detailing each component and

combination that make a crop producer in a more complex system, specifying the acidity when combined with the soil, giving certain percentages where the acidity is at its point so that organic matter in its combination of the highest rate of nutrients to the seed [2].

In turn, the agronomist engineer Juan Antonio Caseres denotes in his document different forms of irrigation to be able to have a better crop, identifying the relationships of organic material, pH, and water to obtain its influence on crop growth, detailing that each crop is different and therefore proposes methods to try that every crop is a producer without the presence of loss [3].

2.3. Key factors in a crop

For processes emphasized in plant growth, such as luminosity and humidity in the environment there is a development of an Artificial Intelligent Lighting System for Protected Crops by Basil Mohammed Al-Hadithia, Cecilia E. García Cenea, Raquel Cedazo Leóna, Carlos Loor Lora, where they propose a control method for artificial lighting in crops, demonstrating that the crop also depends on a certain amount of light, they have combined power electronics with LabView programming, and with this, they have been able to regulate automatically or manually the luminosity of the greenhouse improving its growth and giving the result that luminosity is essential in a nursery [4].

The processes such as irrigation that are vital for crops are automated being aware that each crop is different and knowing that the pH will affect, all outstanding variables are taken into account so that irrigation is a precise succession therefore the technology magazine published an article of the Specialized School of Engineering ITCAP-FEPADE which detailed the process to automate a greenhouse in Cuba, using pc, electrovalves and other instruments at industrial level, to be precise at the time of irrigation and fertilization of planting where great results were obtained in terms of management of irrigation and fertilization [5].

The ways at industrial level are great, since they are more capable of controlling a nursery in an easy way and in some kind of failure these systems are modular, that is, one can change the mechanisms without causing a negative effect to the whole complex, this competes more to the nursery where you get big profits and can invest in an excellent modernization, but in developing countries, these aspects are not supported and that is why you do not have enough help to be able to compete effectively in the agricultural market, The technology magazine published an article from the Escuela Especializada en Ingeniería ITCAP-FEPADE where they detailed the process to automate a greenhouse in El Salvador, determining that there were few companies committed to providing engineering solutions to agribusiness, and that it was possible to do so with the support of the Family Agriculture Plan, They used the Siemens LOGO programmer to automate the greenhouse and also made a greenhouse to take samples to corroborate that the project was an excellent investment, with the result that automated irrigation allows the fruit (whatever it is) to grow faster and with more volume than the others [6].

Several strategies can be presented to obtain a better crop as did the students Martiniano Castro Popoca, Francisco Aguila Marin, Abel Quevedo Nolasco, Siegfried Kleisinger, Leonardo Tijerina Chavez¹, and Enrique Mejia Saenz of the postgraduate school of Texcoco - Mexico and the Hohenheim University of Stuttgart - Germany, in their degree thesis they carried out the irrigation automation for a pumpkin crop in the postgraduate school of Texcoco - Mexico, they used three strategies to make the automated irrigation and to be able to define which strategy was the best, using variables such as air humidity, atmospheric conditions, evotranspiration conditions, pH and organic matter, they obtained a punctual prototype and that fulfilled the requirements chosen to make the proper automatic irrigation [7].

Seeing the case of automation with industrial quality components can also be done with microcontrollers as in the case of Fernanda Beatriz Carmona, Alberto Eduardo Eduardo Riba, Fernando Emmanuel Frati, Jorge Damian Tejada, Horacio Martinez del Pezzo, Emanuel Robador, Martin Paez Yanez, Alejandro Cruz, Nelson Acosta, Juan Manuel Toloza, denote in their article on automated irrigation for olive cultivation, the use of microcontrollers with wireless sensors for proper irrigation, located in an arid region state that the use of sensor-oriented software architecture, make the use of water more optimal and with better results in production [8].

In developed countries, we are already seeing cases of robots in agribusiness, defending that robots do a better job by being more accurate with irrigation, bagging and more actions that in these fields a human being is not so accurate, improving the sowing of crops, allowing the rapid growth of them and also improving the investments of greenhouses because they save on labor costs and their production is much higher than with human activity, in the State of the art of robot technology applied to greenhouses by the students Gutiérrez, S.López, H. C.; Rivera, S. y Ruiz, A. C. from the University of Colima, show how robots can cooperate with the nursery to make it more productive, taking into account factors such as the lighting of the place, pesticides applied to crops, fertilizers, and other variables that have to be included in the programming of the robot to be able to act properly as appropriate, saying that the robot must withstand the conditions of the greenhouses making it precise and with materials that allow it to withstand the dusty environment and full of pesticides found in a greenhouse, robots can help from planting, watering to bagging, showing that there are robots with different degrees of freedom to do their job [9] and in Feasibility analysis of the use of robots in greenhouses. The proposal for the Almeria model by F. Rodriguez, J. Sanchez-Hermosilla, L. Rivera, and A. Gimenez, shows the feasibility of automation of greenhouses, in the region of Almeria, detailing that agriculture will

be the first field in automation since it reduces costs when sowing, bagging, watering and more duties that a worker would do, it would increase production because automation is a synchronous process and thus its product is easier to obtain [10].

3. Theoretical framework

3.1. Humidity sensor

The soil moisture sensor (hygrometer) also known as the FC-28 module is a sensor used mostly in automatic irrigation systems, its operation is simple, it allows one to measure the conductivity of the soil, if the soil is very wet the conductivity will be higher and if the soil is very dry the conductivity will be much lower.

The FC-28 module which is the probe used to measure the humidity is accompanied by another board that is responsible for delivering the sensor measurement in analog or digital form, this board brings an LM393 comparator circuit and a potentiometer. The sensor together with the board in charge of the measurements delivers analog results between the values 0 (very wet soil) and 1023 (too dry soil). The digital output will give HIGH values when a certain level of humidity is exceeded and LOW when the soil humidity is below the level, these values are obtained when the circuit detects that a certain measurement threshold has been passed, this threshold can be modified through the potentiometer [11].

Figure 2. FC-28 module [11].

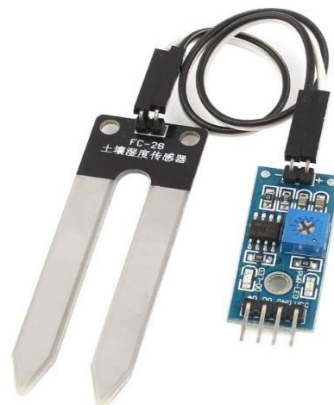

3.2. Rain sensor

This module consists of a series of conductive tracks printed on a Bakelite plate. The spacing between the tracks is very small. What this module does is create a short circuit whenever the tracks get wet. The water causes a low resistance path to be created between the tracks with positive polarity and the tracks connected to GND. The current flowing through these tracks is limited by 10K resistors on each lead, which prevents the short circuit generated when the board gets wet from ruining the microcontroller. The control circuit is the one that has the current limiting resistors and is responsible for powering the YL-83 module. It has an operational amplifier, specifically the LM392 integrated circuit. This is responsible for amplifying the small voltage differential that is generated when a drop of water falls on the tracks of the module. This is where the output signal is generated, which can be analog or digital. The digital signal will oscillate between HIGH and LOW values depending on whether or not there is water on the tracks of the YL-83 board [12].

Figure 3. YL38 module [12].



3.3. Biometric sensors

They have too many purposes due to the help they provide in the industry, being of various kinds depending on the human body, from the iris of the eyes to body odor, with the help of biometric sensors avoids the use of outdated methods of access such as keys or cards,

collaborate avoiding fraud since each being is different from each other and with this cannot access certain places or open certain things.

The most used sensors are the biometric ones by fingerprint, being ordered by the parts of the fingerprint, the island, bifurcation, end, point, and the lake being these 5 details characteristics that all people have but in different ways, the software algorithms make an image analysis, obtaining the original image then taking out the due reflection, the lines are located and the algorithm separates them between 0° , 45° , 90° , and 135° to be able to analyze the image and make a match with the original proceeding to the activation of the access control [13].

The optical method is one of the most common methods, which usually consists of cameras of CCD-type video. These sensors are used in both fingerprint and eye recognition. The heart of the camera is a CCD (Charge Coupled Device) integrated circuit. This device consists of several hundred thousand individual elements (pixels) located on the surface of a tiny IC [14].

Figure 4. Biometric sensor analysis [14].

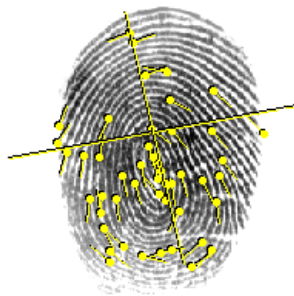

The GT511C3 sensor is a fingerprint scanner that communicates through TTL serial protocol, with a 32-bit CPU, which is responsible for data processing, with large data storage capacity, it also allows retrieving the image of a fingerprint. The module can store up to 200 different fingerprints (which is 10 times more than the previous version) and is now capable of 360° fingerprint recognition. The module is small and easy to mount using two mounting tabs on the side of the sensor. The onboard JST-SH connector has four signals: VCC, GND, Tx, and Rx [15].

Figure 5. GT511C3 sensor [13].



3.4. Raspberry Pi 3

Raspberry Pi is a low-cost reduced-board computer, single-board computer, or single-board computer (SBC) developed in the United Kingdom by the Raspberry Pi Foundation, to stimulate computer science education in schools.

The software is open source, being its official operating system an adapted version of Debian, called Raspbian, although it allows using other operating systems, including a version of Windows 10. In all its versions it includes a Broadcom processor, RAM, a GPU, USB ports, HDMI, Ethernet (The first model did not have it), 40 GPIO pins, and a camera connector. None of its editions includes memory, being in its first version an SD card and in later editions a MicroSD card [16].

Figure 6. Raspberry Pi 3 [16].



3.5. Database

The term database was first heard in 1963, at a symposium held in California, USA. A database can be defined as a set of related information that is grouped or structured. From a computing

point of view, the database is a system consisting of a set of data stored on disks that allow direct access to them and a set of programs that manipulate that set of data. Each database is composed of one or more tables that store a set of data. Each table has one or more columns and rows. The columns store a part of the information about each element that we want to store in the table, each row of the table makes up a record.

Database Management Systems are very specific types of software, dedicated to serving as an interface between the database, the user, and the applications that use it. It is composed of a data definition language, a data manipulation language, and a query language [17].

The architecture of a database system is based on 3 different levels:

- Physical level: is the lowest level of abstraction and the actual level of stored data. This level defines how the data is stored in the physical medium, whether in records or any other form, as well as the access methods. This level is associated with a representation of the data, which is what we call Physical Schema.
- Conceptual level: it corresponds to a view of the database from a real-world point of view. In other words, it deals with the entity or object represented, regardless of how it is represented or stored. It is the representation of the data made by the organization, which gathers the partial data of the requirements of the different users and partial applications. It includes the definition of the data and the relationships between them. This level has a Conceptual Schema associated with it.
- View level: these are parts of the conceptual schema. The conceptual level presents the entire database, while users usually only have access to small parts of it. The vision level is in charge of dividing these parcels. An example would be the case of the employee of an organization who has access to the vision of his payroll, but not to that of his colleagues. The schema associated with this level is the Vision Schema [18].

Figure 7. Database [18].

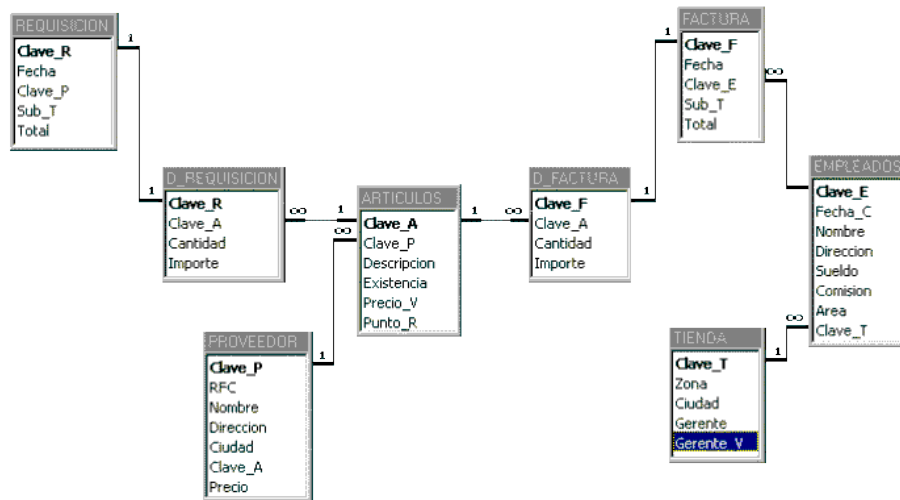

4. Design of irrigation system and fingerprinting system

The system has a base of 50x100 cm of simulation space of rough surfaces of rural agricultural areas to which its applied function is dedicated, Arduino technology will be used due to its easy application and communication plus parameterization of practical sensors such as the SEN-0050 with the following information:

Characteristics:

- Power supply: 3.3V or 5V
- Output voltage: 0 - 4.2V
- Current 32mA
- Pins: Blue (Output), Black (GND), Red (Vdc)
- Dimensions: 60x20x5mm
- Includes connection cable

And the YL-83 rain sensor with the following information:

- Operating voltage: 3.3 - 5 V

- Output forms: digital output (0 and 1) and analog voltage output.
- Sensitivity adjustment with potentiometer
- LED power and digital output status indicator.
- The digital output can supply or drain 100 mA so it can directly drive loads such as buzzers, relays, etc.
- With screw hole for easy installation
- Dimensions: 3.2cm x 1.4cm

Rechargeable batteries connected to both the microcontroller and the sensors will be used for their power supply so that they autonomously perform their proper function in this way when changing it the system does not need to be restarted or stopped, just change the corresponding battery.

The attendance control is made up of a GT511C3 sensor, an Arduino MEGA-2560, an LCD, and a Raspberry Pi 3, the sensor is responsible for obtaining the information of the staff, and through the programming of the Arduino the images are obtained, and converted into ID to be stored in the database; the Raspberry Pi 3 is equipped with a LAMP server (Linux, Apache, MySQL, and PhpMyAdmin) for its versatility and pairing with this board. With the help of MySQL and PhpMyAdmin, the databases are made to conform to the web page which is made with HTML, PHP, and CSS commands, where the administrator can register the personnel and later obtain a report with information of ID, date, and time.

4.1. Entity-Relationship model

For the realization of the database, use is made of the entity-relationship model, which is a tool that allows representation of the relevant entities of an information system as well as their interrelationships and properties. For this project the model will be the following:

Figure 8. Entity-relationship model.

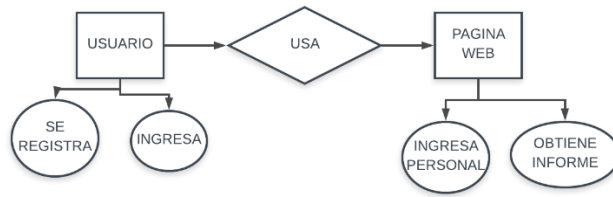

Source: own.

4.2. Programming

4.2.1. Watering diagram

Shows the logic necessary for the irrigation system to be automatic, requiring the humidity and rain sensors to obtain the values and from them to run the solenoid valve for irrigation if it is not raining and the pH is acidic, if it is raining the system will not run anything also all sensor states are displayed through a wireless communication that is connected to the pc and a graphical interface.

Figure 8. Irrigation diagram.

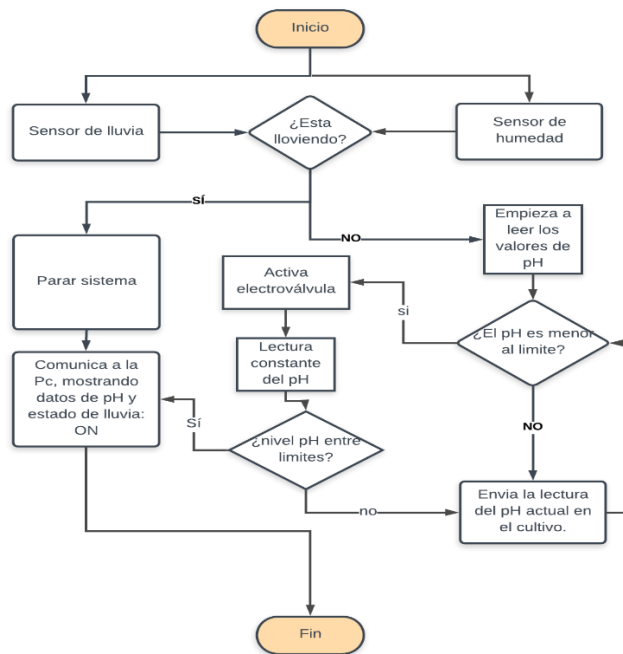

Source: own.

Employing Arduino programming we can divide its functions into steps in sections according to the structure:

Figure 9. Initial structure.

```
#include <EEPROM.h>
#include <SoftwareSerial.h>
#include <LiquidCrystal.h>
LiquidCrystal lcd(8, 9, 4, 5, 6, 7);
#define rxPin 0
#define txPin 1
#define ledPin 13
int valor_limite = 500;
const int sensorPin = 9;
SoftwareSerial xbee = SoftwareSerial(rxPin, txPin);
```

Source: own.

Where we start and activate the EPROM memory of the Arduino, to prevent the program from being lost when restarting the program or removing power to the microcontroller, in addition to defining pins needed for programming and proper operation in the program.

Figure 10. Pin declaration.

```
void setup() {
  lcd.begin(16, 2);
  pinMode(rxPin, INPUT);
  pinMode(txPin, OUTPUT);
  Serial.begin(9600);
  pinMode(13, OUTPUT); //pin detector de nivel
  pinMode(12, OUTPUT); //pin de activador rele
  pinMode(8, OUTPUT);
  pinMode(A15, INPUT);
  pinMode(11, OUTPUT);
  xbee.begin(9600);
```

Source: own.

In this part, the predefined values are started so that they are ready when needed by the program in the LOOP.

Figure 11. Main code.

```
void loop() {

  lcd.setCursor(0,1);
  Serial.println(analogRead(A0));
  int valorHumedad = map(analogRead(A0), 0, 1023, 100, 0);

  if(analogRead(A0) > valor_limite){
    digitalWrite(12,HIGH);
    digitalWrite(8,HIGH);
    digitalWrite(13,HIGH);
    lcd.print("humedad al:");
    lcd.setCursor(11,1);
    lcd.print(valorHumedad);
    lcd.setCursor(13,1);
    lcd.print("%");

    delay(400);
    digitalWrite(13,LOW);
    xbee.print('A');
    delay(100);
  }
  else{
    lcd.setCursor(0,1);
    lcd.print("humedad al:");
    digitalWrite(12,LOW);
    digitalWrite(8,LOW);
    lcd.setCursor(11,1);

    lcd.print(valorHumedad);
    lcd.setCursor(13,1);
    lcd.print("%");
  }
  delay(300);

  Serial.println(analogRead(A1));
  lcd.setCursor(0,0);
  if (analogRead(A1) < 400) {
    digitalWrite(11,HIGH);
    lcd.print("esta lloviendo");
  }
  else{
    digitalWrite(11,LOW);
    lcd.print("sistema activo");
  }

  delay(500);
}
```

Source: own.

In this part the parameterized sensors from 0-1023 will be read in analog data read on pins A0 and A1 for evaluation and activation of either the LEDs or the relay, thus initiating the watering or giving the warning on the interface of its current work.

4.2.2. Visualization and connection model with XBEE S2

Display of the humidity sensor in XCTU on a real-time computer with specific data according to the parameterization.

Figure 12. Xbee data reading.

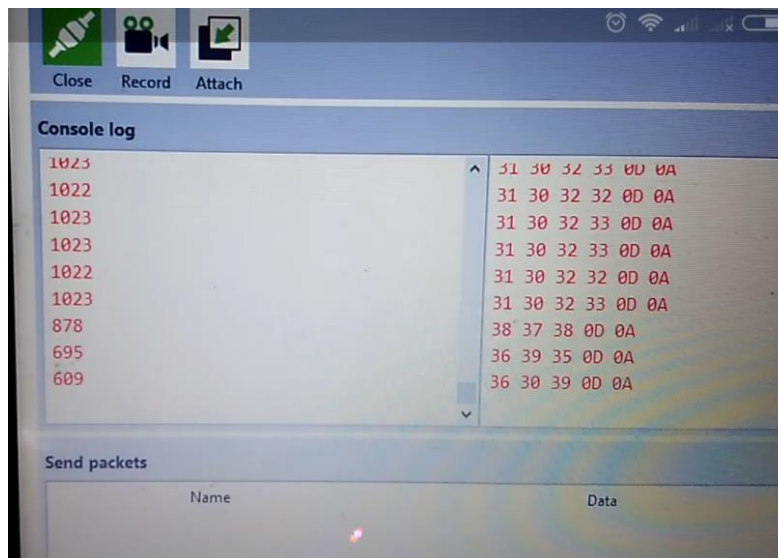

Source: own.

The connection model of the XBEE with the Arduino is done by direct wiring to avoid the manufacture of PCBs that only generate unused or poorly used space occupation. This is with an XBEE shield and standard LEDs.

Figure 13. Arduino Xbee connection.



Source: own.

And the pressure test in an enclosed space to verify the resistance and function of the nebulizers already installed in a mesh hose extension for artificial rain cultivation.

Figure 14. Sprinkler test.



Source: own.

4.3. Attendance control diagram

It consists of three components, the biometric sensor programming, the database programming, and the web page, installed on the Raspberry Pi 3 board.

Figure 15. Hollow diagram.

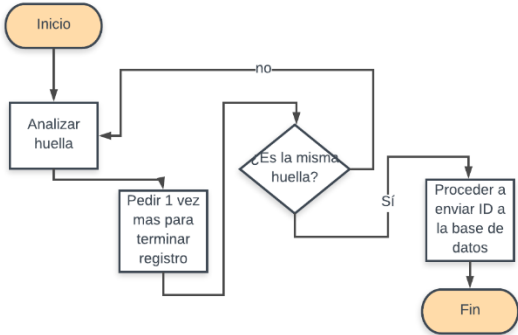

Source: own.

With the characteristics provided by the biometric sensors, the digital identification values can be obtained using an ID to validate the corresponding data of the person, in which the information of the fingerprint is registered, giving it an address in hexadecimal due to how the programming of this is handled.

Figure 16. Database diagram.

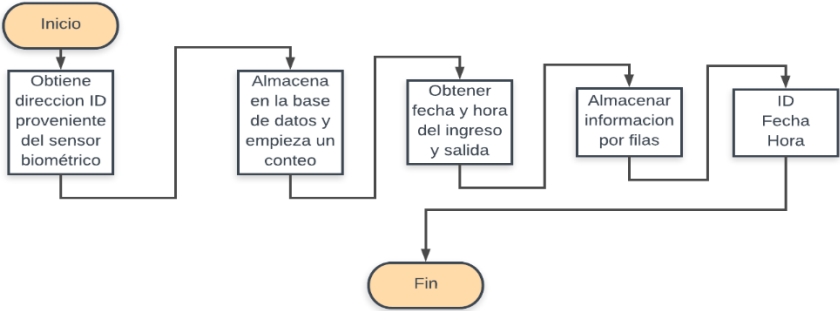

Source: own.

The ID is sent to the MySQL database that is on the server installed on the Raspberry Pi 3 that allows communication via PhpMyAdmin and PHP commands with the web page to obtain reports of the attendance of the staff, this is only allowed for the nursery administrators.

5. Conclusions

Using this means of automation in irrigation systems optimizes production and reduces personnel costs and human error losses.

Thanks to the easy retrofitting of the technology used in rural workspaces, the negative effect on the software and hardware used is reduced.

The use of generic technology in the application of the irrigation system allows it to be easily and economically maintained without the need to interrupt its operation.

With the help of the biometric sensor, it is easy to obtain the identification of the personnel in digital format, in addition with this sensor a verification can be made to avoid the system being sabotaged and several people trying to start without being registered.

The LAMP server is an excellent server for Raspberry systems because they are paired with your processor making it the only server that works for this, allowing greater security and a huge and very structured programming environment allowing the creation of web pages with a structured programming architecture and with little failure to attacks or network failures.

With database management and web page optimization, a user-friendly environment is created allowing the user to access any distribution, manage the information and retrieve it if desired.

References

- [1] Agricultura, "AGRICULTURA: Acidez y Alcalinidad de los Suelos", 2014. [Online]. Available: <http://tiposagricultura.blogspot.com.co/2014/07/acidez-y-alkalinidad-de-los-suelos.html>
- [2] F. M. Águila Marín, A. Quevedo Nolasco, S. Kleisinger, L. Tijerina Chávez, and E. Mejía Sáenz, "Sistema de riego automatizado en tiempo real con balance hídrico, medición de humedad del suelo y lisímetro", *Agricultura técnica en México*, vol. 34, no. 4, 2010.
- [3] S. A. Vaca, E. Serrano Vivas, J. E. Rangel Díaz, "Reverse engineering for electronic devices: temperature and soil moisture case", *Vis. Electron.*, vol. 13, no. 1, pp. 123–134, 2019. <https://doi.org/10.14483/22484728.14404>

- [4] B. M. Al-Hadithi, C. E. García Cena, R. C. León, C. L. Loor, "Desarrollo de un Sistema de Iluminación Artificial Inteligente para Cultivos Protegidos", *Rev. Iberoam. Automática e Informática Ind.*, vol. 13, pp. 421-429, 2016. <https://doi.org/10.1016/j.riai.2016.07.005>
- [5] E. A. Amaya, "Diseño e Implementación de Sistema de Riego Automatizado en un Invernadero de la Escuela Nacional de Agricultura", 2020.
- [6] N. O. Clará, "Invernaderos automatizados para el desarrollo de la agricultura familiar en el Marco de la Seguridad Alimentaria", 2020.
- [7] M. C. Popoca, F. Á. Marín, "Sistema de riego automatizado en tiempo real con balance hídrico, medición de humedad del suelo y lisímetro", *Agric. técnica*, 2008.
- [8] F. B. Carmona et al., "Tecnologías de la información y de las comunicaciones aplicadas a problemas de agricultura regional", 2019
- [9] M. A. García, S. Gutiérrez, H. C. López, S. Y. Rivera, A. C. Ruiz, "State of the art of robot technology applied to greenhouses", *Rev. AIA*, vol. 11, no. 3, pp. 41-52, 2007.
- [10] F. Rodríguez, J. Sánchez-Hermosilla, L. Rivera, A. Giménez, "Análisis de viabilidad de la utilización de robots en invernaderos. Propuesta para el modelo Almería", 2019
- [11] Madness, "Tutorial sensor de humedad de suelo". [Online]. Available: <http://www.madnesselectronics.com/tutorial-sensor-de-humedad-de-suelo/>
- [12] Panama Hitek, "Módulo YL-83: Un detector de lluvia". [Online]. Available: <http://panamahitek.com/modulo-yl-83-un-detector-de-lluvia/>
- [13] Neutron, "SENSORES BIOMETRICOS". [Online]. Available: [http://neutron.ing.ucv.ve/revista-e/No6/Olguin Patricio/SEN BIOMETRICOS.html](http://neutron.ing.ucv.ve/revista-e/No6/Olguin%20Patricio/SEN_BIOMETRICOS.html)
- [14] J. Zambrano Nájera, V. Delgado, y J. J. Vélez Upegui, "Short-term temperature variability in a tropical Andean city Manizales, Colombia", *Rev. Vínculos*, vol. 17, no. 2, pp. 129–139, 2020. <https://doi.org/10.14483/2322939X.17091>
- [15] Didácticas electrónica, "SENSORES: Scanner de huella digital -5v TTL (GT-511C3)". [Online]. Available: <http://www.didacticaselectronicas.com/index.php/sensores/scanner-de-huella-digital-5v-ttl-gt-511c3-detail>
- [16] Raspberry, "Raspberry Pi 3 Model B - Raspberry Pi". [Online]. Available: <https://www.raspberrypi.org/products/raspberry-pi-3-model-b/>
- [17] Maestros web, "¿Qué son las bases de datos?". [Online]. Available: <http://www.maestrosdelweb.com/que-son-las-bases-de-datos/>
- [18] A. L. Fagua Fagua, J. C. Najar Pacheco, "Internet of things, reality of a connected world", *Vis. Electron.*, vol. 14, no. 2, pp. 264–270, 2020. <https://doi.org/10.14483/22484728.16783>