

Space building case

Caso edificio Space

Jeisson D. Coral C.

Universidad Distrital Francisco José de Caldas
jdcoralc@correo.udistrital.edu.co

Cristian E. Camacho P.

Universidad Distrital Francisco José de Caldas
cecamachop@correo.udistrital.edu.co

Brayan A. Torres R.

Universidad Distrital Francisco José de Caldas
bratorresr@correo.udistrital.edu.co

The Space building was a residential complex located in the city of Medellín (Colombia), which was divided into six stages or towers. In the last stage of the project, tower six suffered a structural failure that caused its collapse, which led to the demolition of the other towers. The main issues discussed are related to the design of structures, columns, beams, and loads that a structure can withstand given the terrain and the materials used for construction. In addition, the study carried out by the Universidad de Los Andes, which was the main source of information in the investigation of the collapse and its aftermath, will be presented. This article will collect and show information on this case in the areas directly related to civil engineering and what happened to those involved in the project.

Keywords: Beams, civil engineering, columns, structural design, structural loads

El edificio Space fue un conjunto residencial ubicado en la ciudad de Medellín (Colombia), el cual se dividía en seis etapas o torres. En la última etapa del proyecto, la torres seis, sufrió una falla estructural que produjo el colapso de esta, y esto llevó a la demolición de las demás torres. Los problemas principales que se trataron están relacionados con el diseño de estructuras, columnas, vigas y cargas que puede soportar una estructura dadas las situaciones del terreno y los materiales utilizados para la construcción. Además, se dará a conocer el estudio realizado por la Universidad de Los Andes la cual fue la principal fuente de información en la investigación del colapso y posteriormente a este. El presente artículo recolectará y mostrará información de este caso en los ámbitos ligados directamente a la ingeniería civil y lo ocurrido con los implicados en el proyecto.

Palabras clave: Cargas estructurales, columnas, diseño estructural, ingeniería civil, vigas

Article typology: Research

Date manuscript received: July 25, 2019

Date manuscript acceptance: October 25, 2019

Research funded by: Universidad Distrital Francisco José de Caldas (Colombia).

How to cite: Coral, J., Camacho, C., Torres, B. (2019). *Space building case*. Tekhnê, 16(2), 51 -60.

Introduction

The function of the bone system in the human body is to support, to keep the body rigid internally and externally; the same happens with buildings, these must have their systems that make them rigid to withstand any type of internal and external force, therefore, the bone system of a building consists mainly of columns and beams that provide the necessary support for it to stand and support its weight. If a component of this system were to fail in both cases, the same thing would happen, it would lose support and stiffness, which is why the good design of column and beam proportions is very important (Fig. 1).

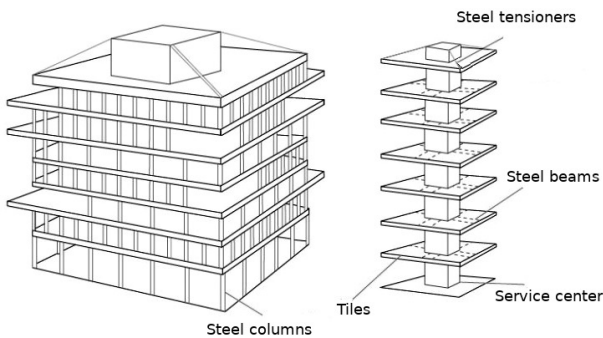

Figure 1. General structure (Alli, 2019).

Taking as a reference the concept given by the engineer López (López, 2005) which defines structures as *"the structure is and has always been an essential component of architecture and civil engineering, and it is precisely the engineer and the architect who, during the design process, must create and invent the structure and give it correct proportions"*.

Bone structure design

Structural design is the creative process where the structural system or skeleton of the building is carried out, in addition to the calculations of the most viable materials to carry out the construction (table 1). ARQHYS magazine defines it as follows: *"structural design is one of the areas where civil engineering is developed and is carried out based on the potential that a material can offer, as well as the natural characteristics that make it specific, its low cost, and its mechanical properties. A failure in the structure can occur when the rigid part and the plastic part of the element is in excess, however, if a good level of these two is maintained it is likely to have optimum performance"* (Arohys, 2018).

Table 1

Conception of a structure (Arohys, 2018).

| | |
|---------------------------|---|
| Structuring | When required, a preliminary structuring will be made proposing the location and dimensions of the structural elements that will allow refining an architectural project. |
| Analysis | It provides us with the displacements and mechanical elements of the members of the structure. |
| Design | Based on the mechanical elements of the analysis, the dimensions and reinforcement of the members of the structure are provided. |
| Drawing | With the above data, the structural drawings are drawn. |
| Calculation memory | A descriptive calculation report of the structure is made, mentioning dead and live loads used, as well as design examples. |

Parts of the building's skeletal system

Concerning the bone systems of the building, it is important to talk about the most important elements, called columns and beams.

Columns are those that help to hold up the mezzanine or other types of elements. The column is the vertical structural element used to support the load of the building (Figs. 2 and 3). It is widely used in architecture because of the freedom it provides to distribute spaces while fulfilling the function of supporting the weight of the construction; it is a fundamental element in the scheme of a structure and the proper selection of its size, shape, spacing, and composition. They have a direct influence on its load-bearing capacity (Gálves, 2017).

The beams are the ones that generate a horizontal load force by supporting the weight and tension of the plates, the dead and live loads of the building (Fig. 4).

The engineers at Arcus Global (construction company) define beams as: *"The beam is the construction element on which the support of all the structures we see every day depends. We must understand that beams are not only intended to support pressure and weight, but also to do bending and tension, it is a horizontal structure that can hold load between two supports without creating lateral thrust, they are ideal for bridges"* (Arcus, 2018).

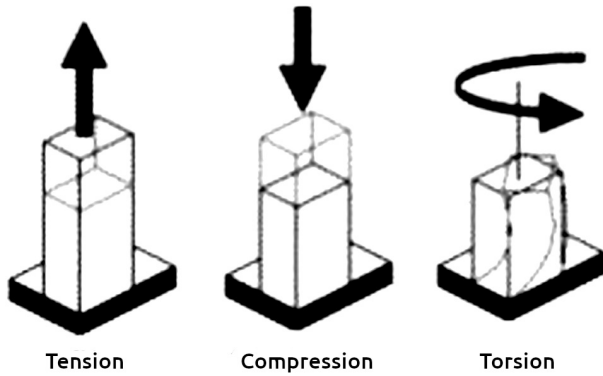

Figure 2. Forces on a column (part A) (Bautista, 2019).

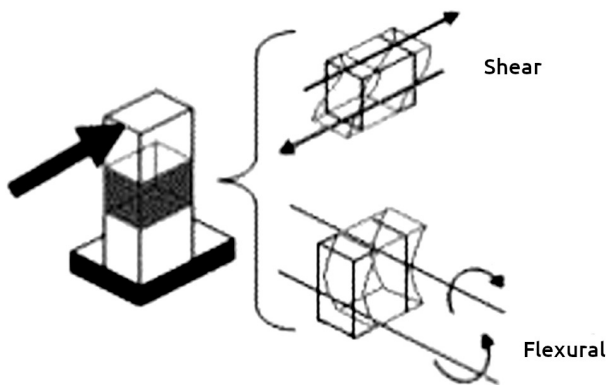

Figure 3. Forces on a column (part B) (Bautista, 2019).

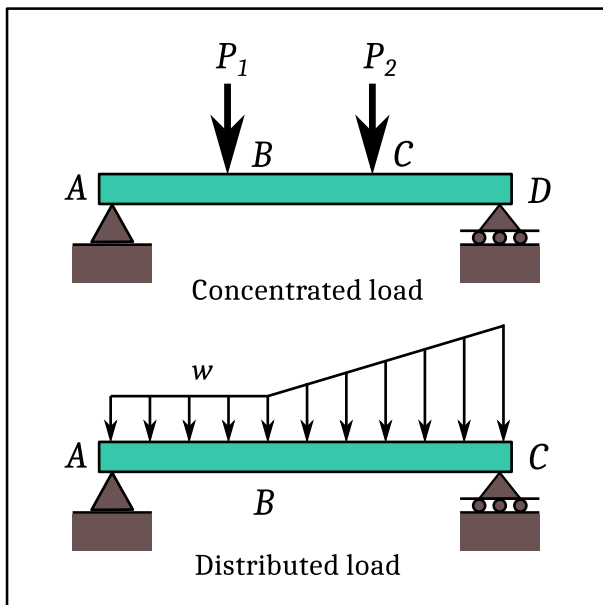

Figure 4. Beams and loads.

Loads to be supported

There are three types of loads in construction (table 2).

Table 2

Types of loads in construction (Aguado, 1994).

| | |
|-------------------------|---|
| Live loads | They vary in intensity over time due to the use or exposure of the structure (human traffic, temperature changes, machinery, snow, or hail accumulation). |
| Dead loads | They act continuously and without significant changes (the self-weight of the structure, floor and ceiling finishes, columns, beams, and slabs, etc.). |
| Accidental loads | They act unexpectedly during indefinite periods (wind gusts, earthquakes). |

Each component mentioned in the table above must resist different types of loads that are fundamental to take into account when designing beams and columns, since the weight of the structure, in general, must be taken into account so that no collapse of the structure is caused.

When carrying out a construction project it is very important to take into account the loads that it must support mainly from the design, with the intention that the building in question supports its weight and the other loads that are applied on the building. Taking the above into account, the engineer must ensure that the materials to be used can meet all the parameters of the project, either the weight of the cement used in the walls and slabs, as well as the thickness and type of rebar in the beams, columns, and slabs of the entire building, being this part of the dead loads that are the main part of the beginning of the project.

Structural walls

Walls have great importance in the design of loads in the structure. Walls are those construction elements with a parallelepiped shape, in which the dimensions of length and height dominate over that of thickness, which primarily fulfills resistant structural missions (transmitting loads of the floors and roofs) and those required insulation functions (phonic and hygrothermal) as well as adequate fire resistance (Diéguez, 2002).

According to their design and mission, they are divided into two main categories (Fig. 5).

Load-bearing walls. If they are not only self-supporting but are also subjected to external loads and thrusts.

Dividing walls. When they have compartmentalization missions and are fundamentally subjected to the action

of their weight and without other mechanical actions than self-supporting.

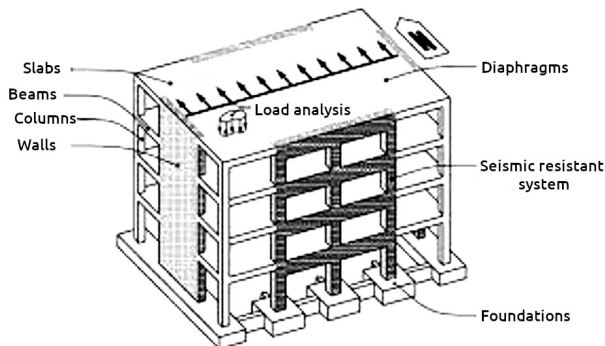

Figure 5. Structural design of a building (Poston, 2019).

Wall symmetry

To verify the distribution of the symmetry of the walls, first, the respective distributions of the walls must be made in the sketch of the plan to be presented, it should be noted that the lengths of the walls that go in the same direction must be similar for greater torsional rigidity in the building. The symmetry can be verified with Eq. 1.

$$\left| \frac{\left[\frac{\sum(L_m b)}{\sum L_m} - \frac{B}{2} \right]}{B} \right| \leq 0.15 \quad (1)$$

Eq. 1 tells us that there is a margin or area of error allowed to consider the house as symmetrical, this margin tells us that our real axis of symmetry, calculated for the proposed design must have a maximum of 15% offset from the theoretical axis to the real axis of the house, which would be half the length of the house, expressed with the letter *B* (Agudelo, 2019).

Footings

The footing is a shallow foundation normally used in soils with medium or high compressive strength, on homogeneous soils (Fig. 6). Its function is to anchor and transmit the stresses generated by a structure to the ground on which it is located. It is located at the base of the structure and is usually found as a concrete prism under the pillars (or columns) of the structure. The division of the footings is detailed in table 3.

A disaster foretold

The Space building in Medellín (Fig. 7) was a project with more than 200 apartments in six stages built on 10,800 square meters by the construction company CDO in the Poblado neighborhood in 2006, which was planned to be built in an area considered unusable by the Mayor's Office of Medellín in the Land Management Plan (POT) (Alvarez,

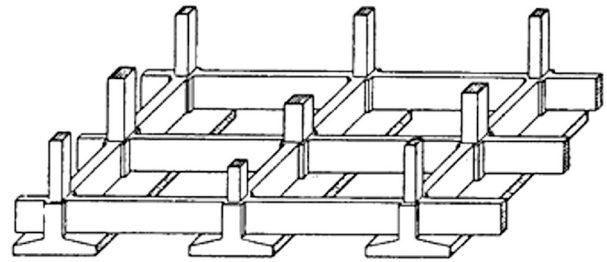

Figure 6. Spread footing in foundation plane (Geotecnia, 2019).

Table 3

Footing types (Arcus, 2017).

| | |
|-------------------------------------|---|
| Flexible footings | This type of footing supports tensile and compressive forces of the structure. |
| Deformable or rigid footings | The edge is equal to or less than the maximum flight measured in both directions. |
| Square footings | They are those with equal sides. |
| Centered footings | This type of footing is tied or braced with concrete or reinforced concrete braces of a section smaller than the footing. |
| Rectangular footings | These are footings with unequal sides. |
| Circular footings | Its main characteristic is its circular shape. |

2017). In 2013, the construction phase of Tower 6 and the entire building was completed.

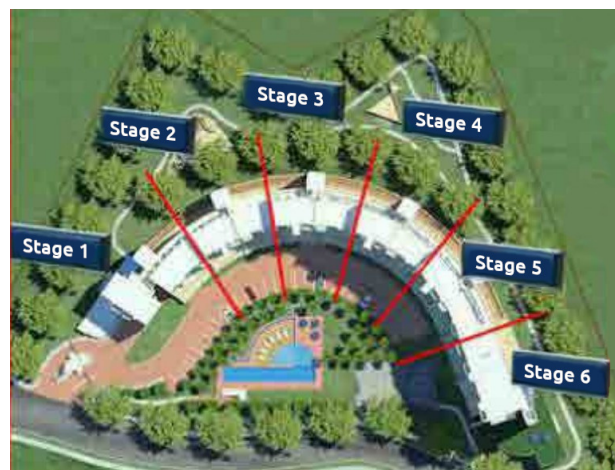

Figure 7. Space building structure design (Suárez, 2019).

Problems in the combined structural system began to become evident in the columns that were the first to fail and the plates began to sag, in addition, cracking was seen

in many main and dividing walls of Tower 6 (Fig. 8). On Friday morning, October 11, 2013, the inhabitants of the Space Building contacted the Administrative Department of Disaster Risk Management (DAGR) because a column of Stage 6 had failed (Toro, Yepes, & Castaño, 2016). This entity observed the problems and the structural failure of the column, therefore, decided to evacuate Stage 6 of the Space Building. For which the construction company stated: "There is no danger for the rest of the building where no structural failure was found".

Photographs taken when the problems started, before the collapse of the building



Figure 8. Photographs of the columns before collapse (Suárez, 2019).

But a few hours after the press release, on October 12, 2013, at night, Tower 6 collapsed (Redaccion, 2013). According to the study conducted and the conclusions delivered to the Mayor's Office by the Universidad de Los Andes, the collapse of stage 6 was mainly related to the lack of structural capacity of the columns of the Space Building. These, according to the study, were not able to withstand the normal loads to which they were subjected.

The primary cause of the collapse of the SPACE building lies in the lack of structural capacity of the building's main columns to resist the acting loads due to the structure's weight and the imposed service loads (Fig. 9). In particular, the columns of the R-3 and S-3 axes presented acting loads that exceeded their capacities at critical points, which caused them to present structural failure by compression on February 20, 2013, and October 11, 2013, the latter one day before the collapse of the building. The lack of structural capacity is associated with deficiencies in the sizing and design of the main structural elements (columns, beams, and slabs).

There is evidence that the building suffered from internal structural problems and pathologies in the months and days before the collapse which include cracks and crevices in masonry partition walls, excessive vertical deflections in the floor slabs, and structural failures in at least two main columns of the building (Fig. 10) (Buitrago, Callejas, & Moreno, 2018; Toro et al., 2016).

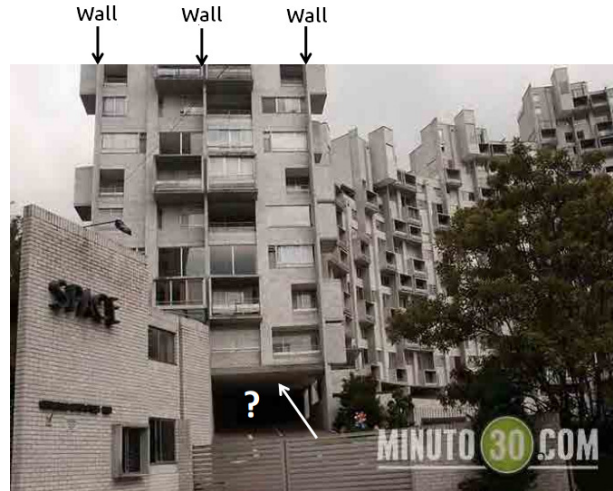

Figure 9. Lack of continuity in structural walls (Suárez, 2019).



Figure 10. Cracks and fissures in dividing walls (Suárez, 2019).

According to the NRS in Title B (loads) a structure must comply with the following requirements (Ingeniería Sísmica, 2010):

- Resistance
- Operation
- Forces caused by imposed deformations
- Analysis

From which the SPACE building did not comply with item A, since the materials used in the plates, columns, and beams were not adequate to support the weight of the building and which was one of the main causes of the collapse of the building, from the above it began to investigate whether the materials used failed, of which engineers warn that in general imported materials that are not of good quality were used in the construction. Particularly with the steel, which is what keeps the beams that support the structure of the entire building standing.

After the collapse of Tower 6, the other towers were demolished because it was concluded that all of them had structural design flaws after studies conducted by the Universidad de Los Andes and the prosecutor's office said: "the columns were not thick enough to support their weight. In addition, it found that there were 5,500 transgressions to the seismic resistance standard in the entire residential complex" (Fig. 11).



Figure 11. Demolition of towers 1, 2, 3, 4 and 5 (Mercado, 2019).

To establish the most probable causes of the collapse, the investigators ruled out hypotheses about possible external events such as earthquakes, landslides, explosions or internal fires, and extraordinary overloads on the building, other than those established in the analysis of the structural conditions of the building itself. It was identified that the building presented several pieces of evidence of internal structural problems and pathologies in the months and days before the collapse (table 4) (SCI, 2014).

Table 4

Structural problems identified.

| |
|---|
| a) Cracks and separations in the internal dividing walls in several of the Stage 6 apartments. |
| b) Excessive vertical deflections in the mezzanine slabs generated overloads in the masonry partition walls and the need for floor backfilling, and therefore, high overloads to achieve the required levelness for the installation of the floor finishes. |
| c) Structural failure due to compression in the R3 shaft column at level 5 reported in February 2013. |
| d) Structural failure by compression in the S3 shaft column at level 4 reported on October 11, 2013. |

The analytical evaluations of structural reliability indicate that the probability of failure of the building, in the conditions in which it was found at the end of the

deconstruction phase, was close to 100%. It was also found that, had the building's columns been adequately sized following current regulations, the probability of failure of the building's critical column would have been very low (less than 0.1%), even considering the occurrence of the differential settlements recorded.

In the opinion of the specialists and experts of the Universidad de Los Andes, if the structure of the SPACE building had been designed in compliance with all the applicable requirements of Law 400 of 1997 and its Regulatory Decrees (NSR-98), Stage 6 would not have collapsed as it did under the imposed conditions (AIR, 2014).

It could be concluded as a result of the tragedy that if all the structural requirements stipulated in Law 400 of 1997 had been fully complied with, which refers to the standards for seismic-resistant constructions, and which in its first article refers to the minimum criteria and requirements for the design, construction and technical supervision of new buildings, as well as those essential for the recovery of the community after the occurrence of an earthquake, which may be subjected to seismic forces and other forces imposed by nature or use, to be able to withstand them, increase their resistance to the effects they produce, minimize the risk of loss of human lives, and defend as far as possible the heritage of the State and citizens (MinAmbiente, 1997).

The main idea that this law wants to make clear with the above article is that each construction must have compliance with each minimum requirement that is presented in the course of this law, which was not fully implemented in the development of the construction of the Space building, without taking into account the risks that would cause and caused if the building failed, which happened and took the lives of 12 people and left homeless many others who lived in each of the 5 remaining towers that had to collapse.

A building designed according to the requirements established in the standards that regulate seismic-resistant constructions must be able to resist, in addition to the forces imposed by its use, low-intensity tremors without damage, moderate tremors without structural damage, but possibly with some damage to nonstructural elements, and a strong tremor with damage to structural and nonstructural elements, but without collapse. Care in design and construction and technical supervision is fundamental for the seismic resistance of structures and nonstructural elements.

The article also stresses the importance of preventing a collapse from the design of the structure, which must be on a ground that can withstand the conditions to which it will be subjected, and which was the main cause of many people being endangered if the structure fails, as in the SPACE case.

Although this case, unfortunately, served to alert the mayor's office of Medellin since in the El Poblado sector there were also large buildings such as the Continental Tower and Asensi building, which also had serious structural

failures, these 3 buildings share a similarity which is the construction firm COD, in the next chapter we will discuss legal issues of the officials involved in the construction of the Space building and everything related to the post-collapse of the building.

The effects of an error

Following the consequences of the collapse and demolition of the other towers, an investigation was carried out to find out what happened and to provide a solution to the problem.

In the case of Continental Towers, one of the buildings evacuated shortly after the collapse of the Space tower, according to the specialist Roberto Rochel, professor at Eafit, it is better to demolish it than to repair it (Fig. 12). The fact that not one but several buildings were evacuated to study their structures, both in El Poblado and in other areas of the city, highlights the probable existence of a systemic problem and not a specific one (Mundo, 2013).



Figure 12. Continental Tower photo, October 2018 (Sánchez, 2019).

After the collapse of tower 6 of the Space building in the El Poblado sector in Medellín, to the disbelief of the people of Antioquia, who believed that these towers were made to last until the end of time, the disbelief increased even more, when several buildings were evacuated for possible construction deficiencies and that had been built or were being built by the company CDO as the Continental Tower building which was one of the buildings evacuated a few days after the collapse of Tower 6, The fact that not one but several buildings were evacuated to study their structures, both in El Poblado and in other areas of the city, highlights the probable existence of a systemic problem and not a specific one (Fig. 13). This case helps to demonstrate that people trust in the durability and resistance that a structure may have because of its aesthetics or architectural design, but they do not see the internal part of the structure which was the cause of the collapse that over time became more evident;

the damage to the columns, the cracks that were created in the main walls and finally a sudden collapse.



Figure 13. Lot of the Space building after demolition (Sáenz, 2019).

As of today, the COD company has not given any response to the owners of the apartments in the Continental Tower building because of the failure to comply with a ruling of the Superintendence of Industry and Commerce, in January 2016, which ordered the construction firm Alsacia CDO to return 13,380 million pesos to about 70 owners of the development (Tiempo, 2018).

The maximization of profits by optimizing materials and spaces to the limit was expressed with the collapse of Space and other buildings that may have to be demolished or repaired, this semi-paralyzed the real estate trade of high-rise buildings in Medellín, especially in the El Poblado sector, which at the time was an alternative to obtaining great wealth, appropriating the urban surplus value.

The topography of El Poblado sets limits to real estate greed, and nature has sent its deadly messages with the Cola del Zorro and Alto Verde landslides in recent years. These kinds of events may be repeated in the future given the characteristics of the creeping, shifting soil in the hills of El Poblado. However, the Space event is unique in that it is not caused by nature, an earthquake, or an earthquake. Space fell to a long experienced and renowned company due to possible structural failures. Only in Medellín, the most innovative city, paradoxically, does a building fall due to construction failures. In this sense, it is imperative for the authorities, starting with the Mayor and the City Council, to take advantage of the crisis to impose stricter and more severe conditions for construction in El Poblado and the city in general through the POT.

A study by anthropologist Paula Sanín Naranjo, March 2010. As a consequence of the approval of Medellín's Land Use Plan in 1999, considerable benefits were given to the subdivision structure, which generated great advantages for building activity and triggered construction activity. A disproportionate growth in an area is considered a symbol

of prestige and exclusivity. To such an extent that in recent years 30% of the city's buildings are in El Poblado.

With growing problems of traffic congestion and environmental pollution, this alternative center of Medellín, in addition to being a reference of better social status, represents the first context to be clarified regarding the collapse of tower 6 of the Space building. In a relatively short time, the area went from being a rural and rural territory close to the mountains in the southeastern sector of the city to an active commercial and housing area, with multiple apartment buildings and a sense of collective security, but a poorly planned development.

In this perspective, after the collapse of tower 6 of the Space building, which destroyed 84 apartments in seconds, the first questions fell on the Second Curator's Office of Medellín. It is worth remembering that the curators emerged in 1994 to decongest the planning offices of the municipalities and speed up the processing of construction licenses, which sometimes took up to five years. The problem is that the issue went the other way and, particularly in Medellín, the real estate boom multiplied their management (Espectador, 2013).

After the disaster, it is now clear that there is a need for more control over the activity of the curators. At least in the capital of Antioquia, with the POT updated in 2006, which stimulated construction in areas such as El Poblado, it is clear that greater vigilance is urgently needed. In the case of the second curator Carlos Alberto Ruiz, today in the eye of the hurricane, he is initially questioned for being the one who granted the urbanization license for the general project and then approved the different stages of construction of the residential unit.

One of the consequences of ignoring or failing to comply with parts of the seismic-resistant standard was the modification of said standard; the engineers who performed the calculations decided to leave aside parts of Law 400 of 1997 (standards on seismic-resistant constructions are adopted); in addition, 10,678 transgressions were made to technical seismic-resistance standards. It was determined that the seismic design parameters were not established or defined and that the mezzanine slabs did not have the minimum stiffness required to limit deflections or other deformations that could impair the strength and functionality of the structure.

One of the changes was the issuance of law 1796 of 2016 known as 'safe housing law' whose purpose is focused on generating measures towards the protection of the home buyer, increase in the safety of buildings, strengthening the public function exercised by urban curators, and likewise establishing other functions to the superintendence of notary and registry.

The issuance of this new law also brought modifications to Law 400 of 1997 in articles (15, 18, 19) affecting the

technical regulation of seismic resistant constructions (NSR), as well as creating the national registry of professionals for the NSR accredited to carry out design, review, and supervision of Law 400 of 1997.

It should be noted that one of the causes of the construction of the towers is due to negligence on the part of the urban curator Carlos Alberto Ruiz Arango, who granted the construction licenses for the different phases of the Space building, after which the Attorney General's Office decided to dismiss him and disqualify him for 8 years.

Edgar Mauricio Ardila Vélez (structural reviewer of the project), Pablo Villegas Mesa (legal representative of the construction company LERIDA CDO), María Cecilia Posada Grisales (engineering director of the work), and Bernardo Antonio Vieco Quiros (responsible for the soil study), all of whom had their professional licenses canceled for different periods as shown in table 5.

Table 5
Detail of penalties imposed on employees.

| OFFICIAL | PENALTY |
|------------------------------------|--|
| Eng. Jorge Aristizábal Ochoa | Cancellation of professional license |
| Eng. Edgar Mauricio Ardila Vélez | Cancellation of professional license |
| Eng. Pablo Villegas Mesa | Cancellation of professional license for 22 months |
| Eng. María Cecilia Posada Grisales | Cancellation of professional license for 20 months |
| Eng. Bernardo Antonio Vieco Quiros | Cancellation of professional license for 6 months |

Another effect of having made the wrong calculations, designs, etc., resulted in a request from the Medellín mayor's office to the engineering faculty of the Universidad de Los Andes to carry out the pertinent studies, evaluations, and diagnoses in four phases (Andes, 2015).

1. Preparation of a technical concept on the Space building about compliance or non-compliance with the legal technical standards applicable to the design and construction processes of the foundation, structure, and non-structural elements.

2. Development of a concept, supported by international experts, on the general conceptualization of the project, the main shortcomings, and problems it presented in light of the state of the art of knowledge and applicable world practice.

3. Conduct the detailed technical studies required to assess the most probable causes of the collapse of Stage 6 of the Space building.

4. Studies, evaluations, diagnoses, and recommendations about the Continental Towers and Asensi buildings for which the Mayor's Office required a technical concept for decision-making purposes related to their safety and functionality.

Conclusions

It has been a little more than five years since the collapse of this building, which has generated great uncertainty about the work of civil engineers when undertaking a project of this size, but despite this, it has left a cold lesson to engineering to take more precautions about the area where it is built, the design and the materials used, since it is a residential construction and the first factor to take into account is the safety of the people who live in it, since that is the main objective of the engineer to create structures that support everything to which it is subjected.

These collapses are not only related to negligence on the part of those in charge of the construction, but also to corruption in these projects, since unauthorized cuts are made in materials and studies related to the building.

In this article we wanted to show the crude reality facing our country, negligence on the part of our large construction companies and professionals in the field of civil engineering since we do not know if more constructions like these, fortunately, have not yet collapsed; another purpose of this article is to inform the people who were always interested in why this building collapsed since unfortunately there was no good information about this case in the media.

References

Aguado, F. (1994). *Introducción a la construcción* (1st ed.). Editorial Pueblo y Educación.

Agudelo, D. (2019). *Título e nsr-10 casas de uno y dos pisos*. Online. Retrieved from <http://www.academia.edu/17360916/Mamposteria>

AIR, O. (2014). *Caso de estudio del edificio space*. Retrieved from https://air.org.co/index.php?option=com_content&view=article&id=58:caso-de-estudio-del-edificio-space&Itemid=75

Alli, C. (2019). *Estructuras*. Online. Retrieved from <https://www.emaze.com/@ALLICRW>

Alvarez, V. (2017). *Space, 4 años de ruinas*. Online. Retrieved from <http://www.elcolombiano.com/antioquia/cuatro-anos-del-desplome-del-edificio-space-en-medellin-BX7451201>

Andes, U. (2015). *Boletín informativo numero 1*. Online. Retrieved from <https://civil.uniandes.edu.co/Boletin/index.php/k2/item/33-conceptouniandes>

Arcus, G. (2017). *Zapatas ¿qué son y cómo se clasifican?* Online. Retrieved from

<http://www.arcus-global.com/wp/zapatas-que-son-y-como-se-clasifican/>

Arcus, G. (2018). *¿qué son las vigas y para qué sirven?* Retrieved from <http://www.arcus-global.com/wp/que-son-las-vigas-y-para-que-sirven/>

Arohys, R. (2018). *Diseño estructural en general*. Online. Retrieved from <https://www.arqhys.com/construccion/disen-estructural.html>

Bautista, L. (2019). *Estructuras y fuerzas*. Online. Retrieved from <https://app.emaze.com/@ALIRRZCC#1>

Buitrago, J., Callejas, N., & Moreno, D. (2018). What are the factors that determine the origin of cracks? *Tekhnê*, 15(2), 13-22.

Diéguez, R. (2002). *Edificio y estructura*. Online. Retrieved from http://fama2.us.es/earq/mdd/construccion1/Objetos%20de%20Aprendizaje/apuntes%20tema_13_muros.pdf

Espectador, E. (2013). *Secretos en desplome del space*. Online. Retrieved from <https://www.elespectador.com/noticias/investigacion/secretos-desplome-del-space-articulo-453315>

Gálves, M. (2017). *Columnas (tipos y clasificación)*. Online. Retrieved from <https://es.slideshare.net/MarlenMGlvez/columnas-tipos-y-clasificacin>

Geotecnia, F. (2019). *Tipos cimentaciones superficiales o directas: Zapatas, losas y pozos de cimentación*. Online. Retrieved from <https://geotecniafacil.com/tipos-cimentaciones-superficiales-o-directas/>

Ingeniería Sísmica, A. C. de. (2010). *Título nsr b-cargas*.

López, A. (2005). *Análisis, diseño y supervisión de estructuras*. Online. Retrieved from <http://www.anadisec.com/disen.html>

Mercado, A. (2019). *Propietarios de los edificios space y continental towers siguen sin respuestas sobre su patrimonio*. Online. Retrieved from <https://www.eltiempo.com/colombia/medellin/edificio-space-los-afectados-por-la-caida-del-space-aun-estan-esperando-su-reparacion-medellin-542788>

MínAmbiente, M. (1997). *Ley 400 de 1997*. Online. Retrieved from http://www.minambiente.gov.co/images/normativa/leyes/1997/ley_0400_1997.pdf

Mundo, E. (2013). *Los efectos de la caída del edificio space*. Online. Retrieved from <https://www.elmundo.com/porta/opinion/columnistas/los-efectos-de-la-caida-del-edificio-space.php#.XGTZ0dJKhtR>

Poston, R. (2019). *La reorganización del reglamento de las construcciones de concreto*

- estructural, aci 318-14*. Online. Retrieved from <https://www.construccionenacero.com/blog/ndeg-06-la-reorganizacion-del-reglamento-de-las-construcciones-de-concreto-estructural-aci-318>
- Redaccion, D. (2013). *Se desplomó el edificio space en el barrio el poblado*. Online. Retrieved from <https://web.archive.org/web/20131106043359/http://diarioadn.com/medell%C3%ADn/mi-ciudad/se-desplom%C3%B3-edificio-en-el-poblado-1.80901>
- Sáenz, R. (2019). *Las lecciones que dej space, a cinco años de su desplome*. Retrieved from <https://www.elcolombiano.com/antioquia/aprendizajes-que-dejo-la-caida-del-edificio-space-AG9484103>
- Sánchez, J. (2019). *Comenzaron audiencias por edificio continental towers, construido por cdo*. Online. Retrieved from <https://www.elcolombiano.com/antioquia/comienzan-audiencias-por-otro-edificio-de-cdo-LA9460379>
- SCI, D. (2014). *Colapso del edificio space en medellín y la ingeniería estructural en colombia*. Online. Retrieved from <https://docplayer.es/5639200-Colapso-del-edificio-space-en-medellin-y-la-ingenieria-estructural-en-colombia.html>
- Suárez, J. (2019). *Edificio space medellin. segunda parte*. Online. Retrieved from <https://www.scg.org.co/wp-content/uploads/space-opt.pdf>
- Tiempo, E. (2018). *Tras 5 años, cdo aún no responde por edificio con fallas en medellín*. Online. Retrieved from <https://www.eltiempo.com/colombia/medellin/cdo-aun-no-responde-por-las-fallas-en-continental-towers-278450>
- Toro, C., Yepes, J., & Castaño, Z. (2016). *La responsabilidad civil extracontractual del estado en el caso del edificio space, medellín 2006-2016*. Unpublished master's thesis, Institución Universitaria de Envigado.

