

## EDITORIAL

CÉSAR AUGUSTO GARCÍA UBAQUE  
DIRECTOR

## INVESTIGACIÓN

### Decision-making model for the development of productive capacity as a component of a knowledge management system

Modelo de toma de decisiones para el desarrollo de la capacidad productiva como un component de un sistema de gestión de conocimiento

CÉSAR AMÍLCAR LÓPEZ BELLO, VÍCTOR HUGO MEDINA GARCÍA, LORNA UDDEN

### Synthesis and characterization of In(O;OH)S/AgInS<sub>2</sub> interface heterojunction

Síntesis y caracterización de interfase de heterojuntura In(O;OH)S/AgInS<sub>2</sub>

WILLIAM VALLEJO, CARLOS DÍAZ URIBE, CARLOS ANDRÉS ARREDONDO, MARIO ALBERTO LUNA, JOHANN HERNÁNDEZ, GERARDO GORDILLO

### Transient surges analysis in low voltage networks

Análisis de transitorios de sobretensión en redes de baja tensión

ANDRÉS ALFONSO RODRÍGUEZ, LUIS EDUARDO PERDOMO ORJUOLA, FRANCISCO SANTAMARÍA PIEDRAHÍTA, CARLOS ANTONIO GÓMEZ VARGAS

### Embedded wavelet analysis of non-audible signals

Análisis embebido por ondículas de señales no audibles

ANDRÉS CAMILO USSA CAYCEDO, OLGA LUCÍA RAMOS SANDOVAL, DARÍO AMAYA HURTADO, JORGE ENRIQUE SÁBY BELTRÁN

### Proposed methodology for assignment of spectral bands in wireless cognitive radio networks

Propuesta metodológica para la asignación de bandas espectrales en redes inalámbricas de radio cognitiva

DANILO ALFONSO LÓPEZ SARMIENTO, EDWIN RIVAS TRUJILLO, OSCAR EDUARDO GUALDRON GUERRERO

### Authenticated encryption of pmu data

Criptoaumentación de datos en una PMU

ELVIS EDUARDO GAONA GARCÍA, SERGIO LEONARDO ROJAS MARTÍNEZ, CESAR LEONARDO TRUJILLO RODRÍGUEZ, EDUARDO ALIRIO MOJICA NAVA

### Potential application of ivim and dwi imaging in parkinson's disease

Aplicación potencial de imágenes ivim y dwi en la enfermedad de parkinson

GLORIA M. CRUZ, SHENGDONG NIE, LIJIA WANG

### Automation of functional annotation of genomes and transcriptome

Automatización de la anotación funcional de genomas y transcriptomas

LUIS FERNANDO CADAVID GUTIÉRREZ, JOSÉ NELSON PÉREZ CASTILLO, CRISTIAN ALEJANDRO ROJAS QUINTERO, NELSON ENRIQUE VERA PARRA

## 12 ESTUDIO DE CASO

### Mechanical resistance of a chemically-modified warm mix asphalt

Resistencia mecánica de una mezcla asfáltica modificada con un aditivo químico

HUGO ALEXANDER RONDÓN QUINTANA, WILMAR DARÍO FERNÁNDEZ GÓMEZ

16

## REVISIÓN

### Development of a uml framework for smart cities with forecasting electrical consumption in Colombia

Desarrollo de un marco de referencia uml para ciudades inteligentes con predicción de consumo eléctrico en Colombia

RICARDO ALIRIO GONZÁLEZ BUSTAMANTE, ROBERTO FERRO ESCOBAR, GIOVANNI TARAZONA BERMÚDEZ

30

### Pedestrian systems design

Diseño de los sistemas peatonales

LINDSAY ÁLVAREZ POMAR, GERMÁN MÉNDEZ GIRALDO, NATÁLIA MARTINS GONÇALVES

41

## REFLEXIÓN

51

### Topological challenges in multispectral image segmentation

Retos topológicos en la segmentación de imágenes multispectrales

JOSÉ ANTONIO VALERO MEDINA, IVÁN ALBERTO LIZARAZO SALCEDO, PAUL ELSNER

61

### Software engineering as a vehicle for water resources environmental planning

La ingeniería de software como vehículo para la planificación ambiental hídrica

JUAN PABLO RODRÍGUEZ MIRANDA, SANDRO JAVIER BOLAÑOS CASTRO, CESAR AUGUSTO GARCÍA UBAQUE

70

### Parallel programming languages on heterogeneous architectures using openmpc, ompss, openacc and openmp

Lenguajes para programación paralela en arquitecturas heterogéneas utilizando openmpc, ompss, openacc y openmp

ESTEBAN HERNÁNDEZ B., GERARDO DE JESÚS MONTOYA GAVIRIA, CARLOS ENRIQUE MONTENEGRO

80

### Integration model for health services in the colombian social security system

Modelo de integración de servicios de salud del sistema de seguridad social colombiano

LILIA EDITH APARICIO PICO, PEDRO ARCO RÍOS, ALEXANDRA LÓPEZ SEVILLANO

90

### Instrucciones para los autores

### Instructions for authors

### Suscripción

### Sign Up

97

109

124

136

150

160

171

183

191

199

200

Tecnura

Doctorate • December 2014

Universidad Distrital Francisco José de Caldas  
Facultad Tecnológica



UNIVERSIDAD DISTRITAL  
FRANCISCO JOSÉ DE CALDAS

Revista Tecnura • Vol. 18 • December 2014

p-ISSN: 0123-921X • e-ISSN: 2248-7638 • Bogotá D.C. Colombia

Special Edition Doctorate

# Tecnura

Tecnología y cultura, afirmando el conocimiento

Universidad Distrital Francisco José de Caldas  
Facultad Tecnológica

Decision-making model for the development of productive capacity as a component of a knowledge management system

Transient surges analysis in low voltage networks

Proposed methodology for assignment of spectral bands in wireless cognitive radio networks

Development of a uml framework for smart cities with forecasting electrical consumption in Colombia



9 770123 921001

# Tecnura

Tecnología y cultura, afirmando el conocimiento

Universidad Distrital Francisco José de Caldas  
Facultad Tecnológica

Vol. 18  
Special Edition Doctorate  
December 2014  
p-ISSN: 0123-921X  
e-ISSN: 2248-7638



UNIVERSIDAD DISTRITAL  
FRANCISCO JOSÉ DE CALDAS

**Revista *TECNURA***  
**Tecnología y cultura, afirmando el conocimiento**  
**Universidad Distrital Francisco José de Caldas**  
**Facultad Tecnológica**

p-ISSN: 0123-921X - e-ISSN: 2248-7638

**EDITOR**

Ph.D. Ing. César Augusto García Ubaque  
Universidad Distrital Francisco José de Caldas, Colombia

**COMITÉ EDITORIAL**

Ph.D. Ing. Electo Eduardo Silva  
Universidad Federal de Itajuba, Brasil

Ph.D. Ing. Manuel Karim Sapag  
Universidad Nacional de San Luis, Argentina

Ph.D. Ing. José Antonio Velásquez Costa  
Universidad Ricardo Palma, Perú

Ph.D. Ing. Johan José Sánchez Mora  
Universidad Simón Bolívar, Venezuela

Ph.D. Ing. Mario Ricardo Arbulu Saavedra  
Universidad de La Sabana, Colombia

Ph.D. Ing. Edgar Francisco Vargas  
Universidad de Los Andes, Colombia

Ph.D. Ing. Jorge Mario Gómez  
Universidad de Los Andes, Colombia

Ph.D. Ing. Ingrid Patricia Páez Parra  
Universidad Nacional de Colombia, Colombia

Ph.D. Ing. César Augusto García Ubaque  
Universidad Distrital Francisco José de Caldas, Colombia

Ph.D(c). Ing. César Augusto Hernández Suárez  
Universidad Distrital Francisco José de Caldas, Colombia

**COMITÉ CIENTÍFICO**

Ph.D. Ing. Enrique Rodríguez de la Colina  
Universidad Autónoma Metropolitana, México

Ph.D. Ing. Alfonso Prieto Guerrero  
Universidad Autónoma Metropolitana, México

Ph.D. Ing. Fernando Martirena  
Universidad Central de Las Villas, Cuba

Ph.D. Ing. Juan Antonio Conesa  
Universidad de Alicante, España

Ph.D. Ing. Steven M. LaValle  
University of Illinois, Estados Unidos

Ph.D. Ing. Graciela Perera Olivares  
Youngstown University, Estados Unidos

Ph.D. Ing. Clara Inés Buriticá  
Universidad Distrital Francisco José de Caldas, Colombia

**EVALUADORES**

Ph.D. Ing. Aldo Hernández Murua  
Universidad de Sinaloa, México

Ph.D. Ing. Darío Amaya Hurtado  
Universidad Militar, Colombia

Ph.D. Ing. Gabriel González Palomino  
Universidad Autónoma De Occidente, Colombia

Ph.D. Ing. John Alexander Bohada Jaime  
Fundación Universitaria Juan De Castellanos, Colombia

M.Sc. Ing. Kelvin De Jesús Beleño Sáenz  
Universidad Autónoma Del Caribe, Colombia

M.Sc. Ing. Luis Gerardo González Morales  
Universidad de los Andes, Venezuela

Ph.D. Ing. Rogerio Atem De Carvalho  
Instituto Federal Fluminense, Brasil

Ph.D. Ing. Ruben Surnames Gonzalez Crespo  
Universidad Internacional De La Rioja –Unir, España

Ph.D. Ing. Víctor González Castro  
Universidad de Saint-Etienne, Francia

Ph.D. Zootecnista. Jaime Enrique Velásquez Restrepo  
Universidad de la Amazonia, Colombia

Ph.D(c). Ing. Astid Rubiano Fonseca  
Paris Ouest University, Colombia

Ph.D(c). Ing. Jose Luis Ramires Arias  
Paris Ouest University, Colombia

M.Sc. Ing. Jhon Jairo Suarez  
Universidad de Pamplona. Colombia

M.Sc. Ing. Luis Eduardo Palomino Bolivar  
Universidad de Caldas, Brasil

M.Sc. Ing. Ricardo Alirio Gonzalez Bustamante  
Universidad Autónoma De Colombia, Colombia

**ASISTENTES DE LA REVISTA TECNURA**

Ing. Hans Raúl Márquez Ramos  
Ing. Diego Armando Giral Ramírez

**COORDINACIÓN EDITORIAL**  
**DITORIAL COORDINATION**

María Elvira Mejía  
Sección de Publicaciones Universidad Distrital Francisco  
José de Caldas

# Tecnura

vol. 18 No - Edición Especial Doctorado  
diciembre 2014

## REVISTA *TECNURA*

La revista *Tecnura* es una publicación institucional de la Facultad Tecnológica de la Universidad Distrital Francisco José de Caldas de carácter científico-tecnológico, arbitrada mediante un proceso de revisión entre pares de doble ciego. La periodicidad de la conformación de sus comités Científico y Editorial está sujeta a la publicación de artículos en revistas indexadas internacionalmente por parte de sus respectivos miembros.

## PERIODICIDAD

Es una publicación de carácter científico-tecnológico con periodicidad trimestral, que se publica los meses de enero, abril, julio y octubre. Su primer número apareció en el segundo semestre del año 1997 y hasta la fecha ha mantenido su regularidad.

## COBERTURA TEMÁTICA

Las áreas temáticas de interés de la revista *Tecnura* están enfocadas a todos los campos de la ingeniería, como la electrónica, telecomunicaciones, electricidad, sistemas, industrial, mecánica, catastral, civil, ambiental, entre otras. Sin embargo, no se restringe únicamente a estas, también tienen cabida los temas de educación y salud, siempre y cuando estén relacionados con la ingeniería. La revista publicará únicamente artículos de investigación científica y tecnológica, de reflexión y de revisión.

## MISIÓN

La revista *Tecnura* tiene como misión divulgar resultados de proyectos de investigación realizados en el área de la ingeniería, a través de la publicación de artículos originales e inéditos, realizados por académicos y profesionales pertenecientes a instituciones nacionales o extranjeras del orden público o privado.

## PÚBLICO OBJETIVO

La revista *Tecnura* está dirigida a docentes, investigadores, estudiantes y profesionales interesados en la actualización permanente de sus conocimientos y el seguimiento de los procesos de investigación científico-tecnológica, en el campo de la ingeniería.

## INDEXACIÓN

*Tecnura* es una publicación de carácter académico indexada en el Índice Bibliográfico Nacional Pubindex (IBN) de Colciencias (Colombia) en la categoría A2, en los índices regionales Scielo Colombia (Colombia) y Redalyc (México); además de las siguientes bases bibliográficas: INSPEC del Institution of Engineering and Technology (Inglaterra), Fuente Académica Premier de EBSCO (Estados Unidos), CABI (Inglaterra), IndexCernicus (Polonia), Informe Académico de Gale Cengage Learning (México), Periódica de la Universidad Nacional Autónoma de México (México), Oceanet (España) y Dialnet de la Universidad de la Rioja (España); también hace parte de los siguientes directorios: Sistema Regional de Información en Línea para Revistas Científicas de América Latina, el Caribe, España y Portugal Latindex (México); Índice Bibliográfico Actualidad Iberoamericana (Chile), e-Revistas (España), DOAJ (Suecia), Ulrich de Proquest (Estados Unidos) y CABI (Reino Unido).

## FORMA DE ADQUISICIÓN

La revista *Tecnura* se puede adquirir a través de compra, canje o suscripción.

## SUSCRIPCIÓN

El precio unitario de la revista es de 10000 pesos (el precio no incluye el valor del envío). La suscripción anual tiene un costo de 45000 pesos para Colombia, 40 USD para América Latina y el Caribe, 60 USD para otras regiones (el precio incluye el valor del envío). Para suscribirse utilice el formato ubicado al final de la revista.

## REPRODUCCIÓN

Se autoriza la reproducción total o parcial de los artículos de esta revista para uso académico o interno de las instituciones citando la fuente y el autor. Las ideas expresadas se publican bajo la exclusiva responsabilidad de los autores y no necesariamente reflejan el pensamiento del Comité Editorial de la revista.

## DIRECCIÓN POSTAL

Enviar a Ing. Cesar Augusto García Ubaque, Ph.D.  
Director y Editor Revista *Tecnura*  
Sala de Revistas, Bloque 5, Oficina 305.  
Facultad Tecnológica  
Universidad Distrital Francisco José de Caldas  
Transversal 70B No. 73A - 35 sur  
Teléfono: 571 - 3238400, extensión: 5003  
Celular: 57 - 3153614852  
Bogotá, D.C., Colombia  
Correo electrónico:  
tecnura@udistrital.edu.co, tecnura@gmail.com  
Tecnura en internet:  
<http://revistas.udistrital.edu.co/ojs/index.php/Tecnura>

## DISEÑO ORIGINAL

Julián Hernández - Taller de Diseño

## CORRECCIÓN DE ESTILO PARA ESPAÑOL

Hernando García Bustos

## CORRECCIÓN DE ESTILO PARA INGLÉS

José Humberto Beltrán

## DIAGRAMACIÓN ELECTRÓNICA Y DISEÑO DE CUBIERTA

Sonia Montaña Bermúdez

## IMPRESIÓN

Imprenta Universidad Distrital Francisco José de Caldas  
Formato: 21.5 x 28 cm  
Papel: Bond 75g  
Fuente: Times New Roman  
Tiraje: 400 ejemplares





UNIVERSIDAD DISTRITAL  
FRANCISCO JOSÉ DE CALDAS

**Tecnura**  
**Technology And Culture, Affirming Knowledge**  
**District University Francisco José De Caldas**  
**Faculty Of Technology**

**EDITOR**

Ph.D. Ing. Cesar Augusto García Ubaque  
District Francisco José de Caldas University, Colombia

**EDITORIAL COMMITTEE**

Ph.D. Ing. Electo Eduardo Silva  
Universidad Federal de Itajuba, Brasil

Ph.D. Ing. Manuel Karim Sapag  
Universidad Nacional de San Luis, Argentina

Ph.D. Ing. José Antonio Velásquez Costa  
Universidad Ricardo Palma, Perú

Ph.D. Ing. Johan José Sánchez Mora  
Universidad Simón Bolívar, Venezuela

Ph.D. Ing. Mario Ricardo Arbulu Saavedra  
Universidad de la Sabana, Colombia

Ph.D. Ing. Edgar Francisco Vargas  
Universidad de los Andes, Colombia

Ph.D. Ing. Jorge Mario Gomez  
Universidad de los Andes, Colombia

Ph.D. Ing. Ingrid Patricia Páez Parra  
Universidad Nacional de Colombia, Colombia

Ph.D. Ing. Cesar Augusto García Ubaque  
Universidad Distrital Francisco José de Caldas, Colombia

Ph.D (c). Ing. Cesar Augusto Hernández Suárez  
Universidad Distrital Francisco José de Caldas, Colombia

**SCIENTIFIC COMMITTEE**

Ph.D. Ing. Enrique Rodríguez de la Colina  
Universidad Autónoma Metropolitana, México

Ph.D. Ing. Alfonso Prieto Guerrero  
Universidad Autónoma Metropolitana, México

Ph.D. Ing. Fernando Martirena  
Universidad Central de Las Villas, Cuba

Ph.D. Ing. Juan Antonio Conesa  
Universidad de Alicante, España

Ph.D. Ing. Steven M. LaValle  
University of Illinois, Estados Unidos

Ph.D. Ing. Graciela Perera Olivares  
Youngstown University, Estados Unidos

Ph.D. Ing. Clara Inés Buritica  
Universidad Distrital Francisco José de Caldas, Colombia

**EVALUATORS**

Ph.D. Ing. Aldo Hernández Murua  
Universidad de Sinaloa, México

Ph.D. Ing. Darío Amaya Hurtado  
Universidad Militar, Colombia

Ph.D. Ing. Gabriel González Palomino  
Universidad Autónoma De Occidente, Colombia

Ph.D. Ing. John Alexander Bohada Jaime  
Fundación Universitaria Juan De Castellanos, Colombia

M.Sc. Ing. Kelvin De Jesús Beleño Sáenz  
Universidad Autónoma Del Caribe, Colombia

M.Sc. Ing. Luis Gerardo González Morales  
Universidad de los Andes, Venezuela

Ph.D. Ing. Rogerio Atem De Carvalho  
Instituto Federal Fluminense, Brasil

Ph.D. Ing. Ruben Surnames Gonzalez Crespo  
Universidad Internacional De La Rioja –Unir, España

Ph.D. Ing. Víctor González Castro  
Universidad de Saint-Etienne, Francia

Ph.D. Zootecnista. Jaime Enrique Velásquez Restrepo  
Universidad de la Amazonia, Colombia

Ph.D(c). Ing. Astid Rubiano Fonseca  
Paris Ouest University, Colombia

Ph.D(c). Ing. Jose Luis Ramires Arias  
Paris Ouest University, Colombia

M.Sc. Ing. Jhon Jairo Suarez  
Universidad de Pamplona. Colombia

M.Sc. Ing. Luis Eduardo Palomino Bolivar  
Universidad de Caldas, Brasil

M.Sc. Ing. Ricardo Alirio Gonzalez Bustamante  
Universidad Autónoma De Colombia, Colombia

**TECNURA JOURNAL ASSISTANTS**

Ing. Hans Raúl Márquez Ramos  
Ing. Diego Armando Giral Ramírez

**EDITORIAL COORDINATION**

María Elvira Mejía  
Sección de Publicaciones Universidad Distrital Francisco  
José de Caldas

# Tecnura

Vol. 18 - Special Edition Doctorate  
December 2014

## LOMO

ISSN 0123-921X  
Volumen 18 - Special Edition Doctorate

## PORTADA

Tecnura Journal • Volumen 18 - Special Edition Doctorate  
• December 2014  
p-ISSN: 0123-921X • e-ISSN: 2248-7638 • Bogotá D.C.  
Colombia

## TECNURA JOURNAL

*Tecnura Journal* is an institutional scientific-technological publication from the Faculty of Technology at District University Francisco José de Caldas, arbitrated by means of a double-blinded peer review process. The periodicity for its Scientific and Editorial committees line-up is subject to the publication of articles in internationally indexed magazines by its own members.

## PERIODICITY

*Tecnura journal* is a scientific-technological publication with quarterly periodicity, published in January, April, July and October. Its first edition appeared in the second term, 1997 and its editions have normally continued from that year and on.

## THEMATIC COVERAGE

The thematic areas of interest at *Tecnura journal* are focused on all fields of engineering such as electronical, telecommunications, electrical, computer, industrial, mechanical, cadastral, civil, environmental, etc. However, it is not restricted to those, there is also room for education and health topics as well, as long as they are related to engineering. The journal will only publish scientific and technological research, reflection and review articles.

## MISSION

*Tecnura journal* is aimed at publishing research project results carried out in the field of engineering, through the publishing of original and unpublished articles written by academics and professionals from national or international public or private institutions.

## TARGET AUDIENCE

*Tecnura journal* is directed to professors, researchers, students and professionals interested in permanent update of their knowledge and the monitoring of the scientific-technological research processes in the field of engineering.

## INDEXING

Tecnura is an academic publication indexed in the Índice Bibliográfico Nacional Publindex (IBN) from Colciencias (Colombia) in the category A2, in the Regional Index Scielo Colombia (Colombia) and Redalyc (México); as well as the following bibliographic databases: INSPEC of the Institution of Engineering and Technology (England), Fuente Académica Premier of EBSCO (United States), CABI (England), Index Copernicus (Poland), Informe Académico of Gale Cengage Learning (México), Periódica of the Universidad Nacional Autónoma de México (México), Oceanet

(Spain) and Dialnet of the Universidad de la Rioja (Spain); it is also part of the following directories: Online Regional Information System for Scientific Journals from Latin America, Caribbean, Spain and Portugal Latindex (México), bibliographic index Actualidad Iberoamericana (Chile), e-Revistas (Spain), DOAJ (Sweden), Ulrich of Proquest (United States) and CABI (United Kingdom).

## FORM OF ACQUISITION

*Tecnura journal* is available through purchase, exchange or subscription.

## SIGN UP

The unit price of the journal is 6 USD (the price does not include shipping). The annual sign up is 28 USD for Colombia; 40 USD in Latin America and the Caribbean; 60 USD in other regions (the price includes shipping). To sign up, use the format located at the end of the journal.

## REPRODUCTION

The total or partial reproduction of the articles of this journal is authorized for academic or internal purpose of the institutions citing the source and the author. Ideas expressed are published under exclusive responsibility of the authors and they do not necessarily reflect the thought of the editorial committee of the journal.

## POSTAL ADDRESS

Send to Engr. Cesar Augusto García Ubaque, Ph.D.  
Director and Editor Revista Tecnura  
Sala de Revistas, Bloque 5, Oficina 305.  
Faculty of Technology  
Universidad Distrital Francisco José de Caldas  
Transversal 70B No. 73A - 35 sur  
Telephone Number: 571 - 3238400, extension: 5003  
Cell phone Number: 57 - 3153614852  
Bogotá D.C., Colombia

E-mail:  
tecnura@udistrital.edu.co,  
tecnura@gmail.com

Tecnura on internet:  
<http://revistas.udistrital.edu.co/ojs/index.php/Tecnura>

## ORIGINAL DESIGN

Julián Hernández - Taller de Diseño

## STYLE CORRECTION IN ENGLISH

José Humberto Beltrán

## LAYOUT AND TITLE PAGE DISEGN

Sonia Montaña Bermúdez

## PRINTED BY

Universidad Distrital Francisco Jose de Caldas Press  
Format: 21.5 x 28 cm  
Paper: Bond 75g  
Font: Times New Roman  
Printing: 400 copies

## DECLARACIÓN DE ÉTICA Y BUENAS PRÁCTICAS

El comité editorial de la revista *Tecnura* está comprometido con altos estándares de ética y buenas prácticas en la difusión y transferencia del conocimiento, para garantizar el rigor y la calidad científica. Es por ello que ha adoptado como referencia el Código de Conducta que ha establecido el Comité de Ética de Publicaciones (COPE: Committee on Publication Ethics) para editores de revistas científicas, dentro de los cuales se destaca:

### Obligaciones y responsabilidades generales del equipo editorial

En su calidad de máximos responsables de la revista, el comité y el equipo editorial de *Tecnura* se comprometen a:

- Aunar esfuerzos para satisfacer las necesidades de los lectores y autores.
- Propender por el mejoramiento continuo de la revista.
- Asegurar la calidad del material que se publica.
- Velar por la libertad de expresión.
- Mantener la integridad académica de su contenido.
- Impedir que intereses comerciales comprometan los criterios intelectuales.
- Publicar correcciones, aclaraciones, retractaciones y disculpas cuando sea necesario.

### Relaciones con los lectores

Los lectores estarán informados acerca de quién ha financiado la investigación y sobre su papel en la investigación.

### Relaciones con los autores

*Tecnura* se compromete a asegurar la calidad del material que publica, informando sobre los objetivos y normas de la revista. Las decisiones de los editores para aceptar o rechazar un documento para su publicación se basan únicamente en la relevancia del trabajo, su originalidad y la pertinencia del estudio con relación a la línea editorial de la revista.

La revista incluye una descripción de los procesos seguidos en la evaluación por pares de cada trabajo recibido. Cuenta con una guía de autores en la que se presenta esta información. Dicha guía se actualiza regularmente y contiene un vínculo a la presente declaración ética. Se reconoce el derecho de los autores a apelar las decisiones editoriales.

Los editores no modificarán su decisión en la aceptación de envíos, a menos que se detecten irregularidades o situaciones extraordinarias. Cualquier cambio en los miembros del equipo editorial no afectará las decisiones ya tomadas, salvo casos excepcionales en los que confluyan graves circunstancias.

### Relaciones con los evaluadores

*Tecnura* pone a disposición de los evaluadores una guía acerca de lo que se espera de ellos. La identidad de los evaluadores se encuentra en todo momento protegida, garantizando su anonimato.

### Proceso de evaluación por pares

*Tecnura* garantiza que el material remitido para su publicación será considerado como materia reservada y confidencial mientras que se evalúa (doble ciego).

### Reclamaciones

*Tecnura* se compromete responder con rapidez a las quejas recibidas y a velar para que los demandantes insatisfechos puedan tramitar todas sus quejas. En cualquier caso, si los interesados no consiguen satisfacer sus reclamaciones, se considera que están en su derecho de elevar sus protestas a otras instancias.

### Fomento de la integridad académica

*Tecnura* asegura que el material que publica se ajusta a las normas éticas internacionalmente aceptadas.

Protección de datos individuales

*Tecnura* garantiza la confidencialidad de la información individual (por ejemplo, de los profesores y/o alumnos participantes como colaboradores o sujetos de estudio en las investigaciones presentadas).

### Seguimiento de malas prácticas

*Tecnura* asume su obligación para actuar en consecuencia en caso de sospecha de malas prácticas o conductas inadecuadas. Esta obligación se extiende tanto a los documentos publicados como a los no publicados. Los editores no sólo rechazarán los manuscritos que planteen dudas sobre una posible mala conducta, sino que se consideran éticamente obligados a denunciar los supuestos casos de mala conducta. Desde la revista se realizarán todos los esfuerzos razonables para asegurar que los trabajos sometidos a evaluación sean rigurosos y éticamente adecuados.

### Integridad y rigor académico

Cada vez que se tenga constancia de que algún trabajo publicado contiene inexactitudes importantes, declaraciones engañosas o distorsionadas, debe ser corregido de forma inmediata.

En caso de detectarse algún trabajo cuyo contenido sea fraudulento, será retirado tan pronto como se conozca, informando inmediatamente tanto a los lectores como a los sistemas de indexación.

Se consideran prácticas inadmisibles, y como tal se denunciarán las siguientes: el envío simultáneo de un mismo trabajo a varias revistas, la publicación duplicada o con cambios irrelevantes o parafraseo del mismo trabajo, o la fragmentación artificial de un trabajo en varios artículos.

### Relaciones con los propietarios y editores de revistas

La relación entre editores, editoriales y propietarios estará sujeta al principio de independencia editorial. *Tecnura* garantizará siempre que los artículos se publiquen con base en su calidad e idoneidad para los lectores, y no con vistas a un beneficio económico o político. En este sentido, el hecho de que la revista no se rija por intereses económicos, y defienda el ideal de libre acceso al conocimiento universal y gratuito, facilita dicha independencia.

### Conflicto de intereses

*Tecnura* establecerá los mecanismos necesarios para evitar o resolver los posibles conflictos de intereses entre autores, evaluadores y/o el propio equipo editorial.

### Quejas/denuncias

Cualquier autor, lector, evaluador o editor puede remitir sus quejas a los organismos competentes.

## CODE OF ETHICS AND GOOD PRACTICE

The editorial board of *Tecnura* journal is committed to ethics high standards and good practice for knowledge dissemination and transfer, in order to ensure rigour and scientific quality. That is why it has taken as reference the Code of Conduct, which has been established by the Committee on Publication Ethics (COPE) for scientific journal editors; outlining the following:

### General duties and responsibilities of the editorial board

As most responsible for the journal, *Tecnura* committee and the editorial board are committed to:

Joining efforts to meet the readers and authors' needs.

- Tending to the continuous improvement of the Journal.
- Ensuring quality of published material.
- Ensuring freedom of expression.
- Maintaining the academic integrity of their content.
- Prevent commercial interests compromise intellectual standards.
- Post corrections, clarifications, retractions and apologies when necessary.

### Relations with readers

Readers will be informed about who has funded research and their role in the research.

### Relations with authors

*Tecnura* is committed to ensuring the quality of published material, informing the goals and standards of the journal. The decisions of publishers to accept or reject a paper for publication are based solely on the relevance of the work, originality and pertinence of the study with journal editorial line.

The journal includes a description of the process for peer evaluation of each received work, and has an authors guide with this information. The guide is regularly updated and contains a link to this code of ethics. The journal recognizes the right of authors to appeal editorial decisions. Publishers will not change their decision in accepting or rejecting articles, unless extraordinary circumstances or irregularities are detected. Any change in the editorial board members will not affect decisions already made, except for unusual cases where serious circumstances converge.

### Relations with evaluators

*Tecnura* makes available to reviewers a guide to what is expected from them. Reviewers' identity is protected at all times, ensuring anonymity.

### Peer review process

*Tecnura* ensures that material submitted for publication will be considered private and confidential issue while being reviewed (double blind).

### Claims

*Tecnura* is committed to respond quickly to complaints and ensure that dissatisfied claimant can process all complaints. In any case, if applicants fail to satisfy their claims, the journal considers that they have the right to raise their protests to other instances.

### Promoting Academic Integrity

*Tecnura* ensures that the published material conforms to internationally accepted ethical standards.

### Protection of individual data

*Tecnura* guarantees the confidentiality of individual information (e.g. participant teachers and/or students as collaborators or subjects of study in the presented research).

### Tracking malpractice

*Tecnura* accepts the obligation to act accordingly in case of suspected malpractice or misconduct. This obligation extends both to publish and unpublished documents. The editors not only reject manuscripts with doubts about possible misconduct, but they are considered ethically obligated to report suspected cases of misconduct. From the journal every reasonable effort is made to ensure that works submitted for evaluation are rigorous and ethically appropriate.

### Integrity and academic rigour

Whenever evidence that a published work contains significant misstatements, misleading or distorted statements, it must be corrected immediately.

In case of any work with fraudulent content is detected, it will be removed as soon as it is known, and immediately informing both readers and indexing systems.

Practices that are considered unacceptable and as such will be reported: simultaneous sending of the same work to various journals, duplicate publication with irrelevant changes or paraphrase of the same work, or the artificial fragmentation of a work in several articles.

### Relations with owners and journal editors

The relation between editors, publishers and owners will be subject to the principle of editorial independence. *Tecnura* will ensure that articles are published based on their quality and suitability for readers, and not for an economic or political gain. In this sense, the fact that the journal is not governed by economic interests, and defends the ideal of universal and free access to knowledge, provides that independence.

### Conflict of interest

*Tecnura* will establish the necessary mechanisms to avoid or resolve potential conflicts of interest between authors, reviewers and/or the editorial board itself.

### Complaints / allegations

Any author, reader, reviewer or editor may refer their complaints to the competent authorities.



# Contents

## EDITORIAL

CÉSAR AUGUSTO GARCÍA UBAQUE  
DIRECTOR

12

## INVESTIGACIÓN

### Decision-making model for the development of productive capacity as a component of a knowledge management system

Modelo de toma de decisiones para el desarrollo de la capacidad productiva como un component de un sistema de gestión de conocimiento

CÉSAR AMÍLCAR LÓPEZ BELLO, VÍCTOR HUGO MEDINA GARCÍA, LORNA UDDEN

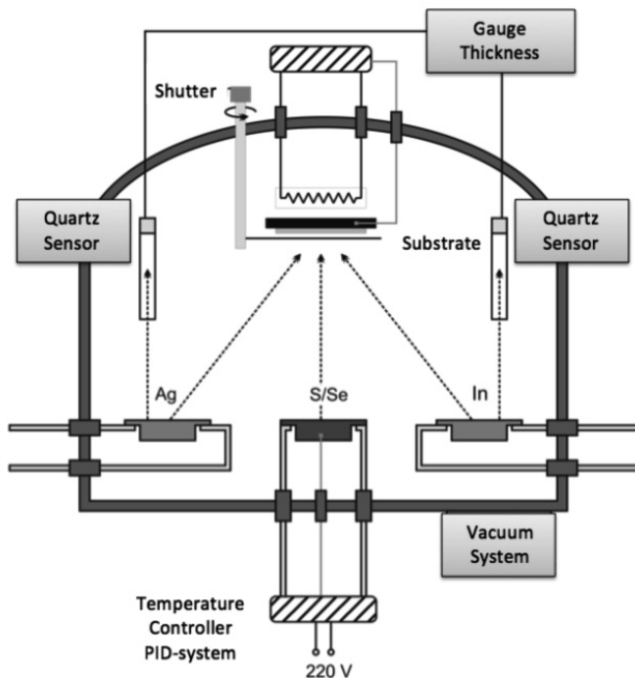
16

### Synthesis and characterization of In(O;OH)S/AgInS<sub>2</sub> interface heterojunction

Síntesis y caracterización de interfase de heterojuntura In(O;OH)S/AgInS<sub>2</sub>

WILLIAM VALLEJO, CARLOS DÍAZ URIBE, CARLOS ANDRÉS ARREDONDO, MARIO ALBERTO LUNA, JOHANN HERNÁNDEZ, GERARDO GORDILLO

30



### Transient surges analysis in low voltage networks

Análisis de transitorios de sobretensión en redes de baja tensión

ANDRÉS ALFONSO RODRÍGUEZ, LUIS EDUARDO PERDOMO ORJUELA, FRANCISCO SANTAMARÍA PIEDRAHÍTA, CARLOS ANTONIO GÓMEZ VARGAS

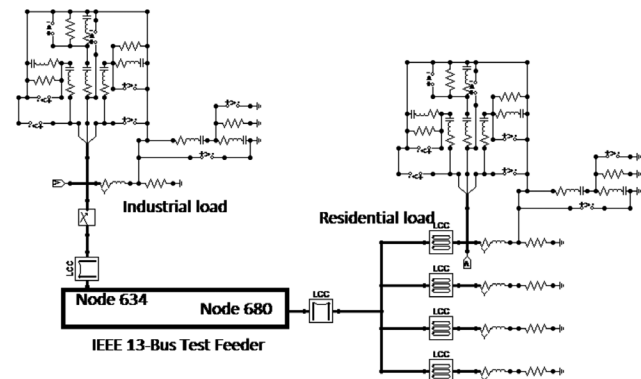
41

### Embedded wavelet analysis of non-audible signals

Análisis embebido por ondículas de señales no audibles

ANDRÉS CAMILO USSA CAYCEDO, OLGA LUCÍA RAMOS SANDOVAL, DARÍO AMAYA HURTADO, JORGE ENRIQUE SABY BELTRÁN

51

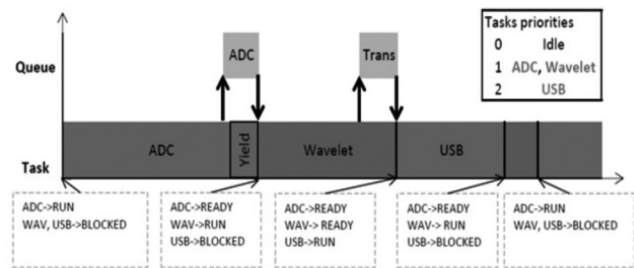


### Proposed methodology for assignment of spectral bands in wireless cognitive radio networks

Propuesta metodológica para la asignación de bandas espectrales en redes inalámbricas de radio cognitiva

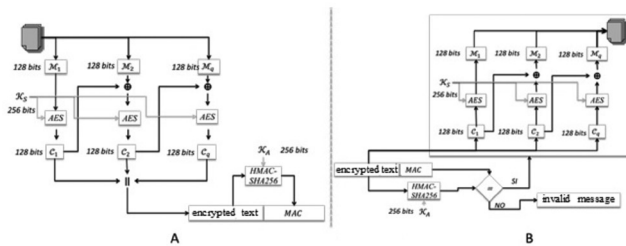
DANILO ALFONSO LÓPEZ SARMIENTO, EDWIN RIVAS TRUJILLO, OSCAR EDUARDO GUALDRON GUERRERO

61

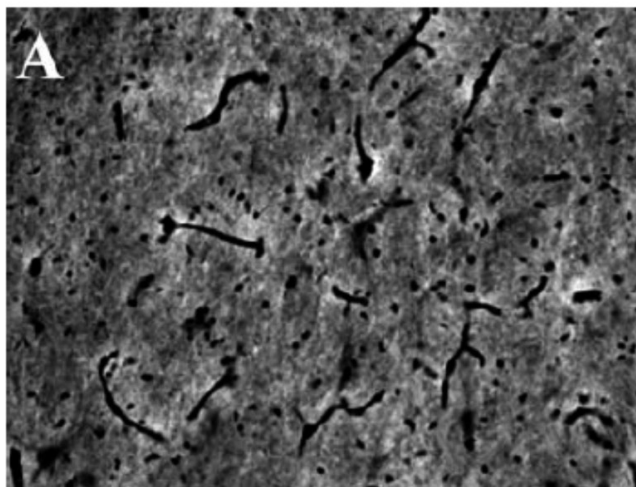




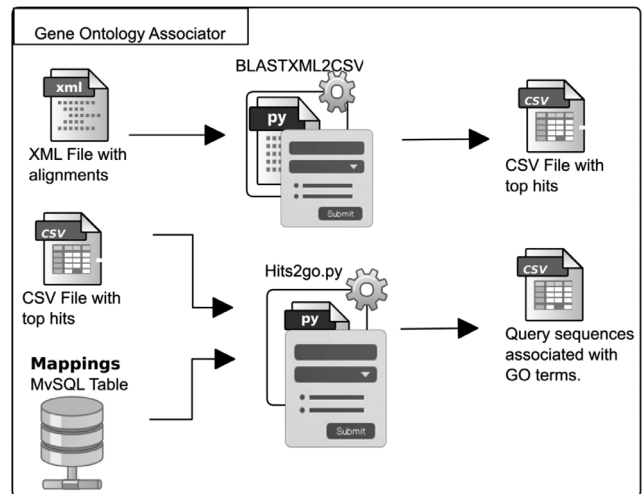
**Authenticated encryption of pmu data** 70  
 Criptoautenticación de datos en una PMU  
 ELVIS EDUARDO GAONA GARCÍA, SERGIO LEONARDO ROJAS MARTÍNEZ, CESAR LEONARDO TRUJILLO RODRÍGUEZ, EDUARDO ALIRIO MOJICA NAVA



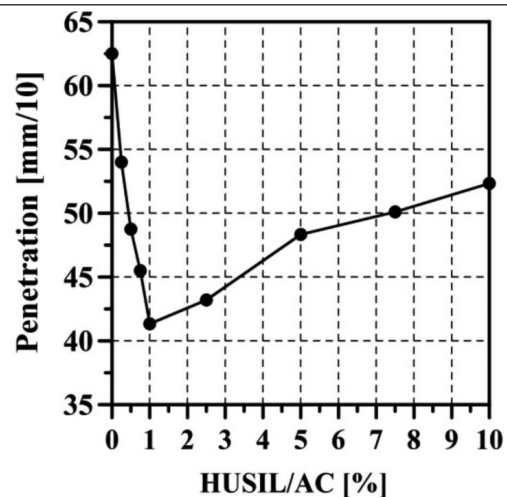
**Potential application of ivim and dwi imaging in parkinson's disease** 80  
 Aplicación potencial de imágenes ivim y dwi en la enfermedad de parkinson  
 GLORIA M. CRUZ, SHENGDONG NIE, LIJIA WANG



**Automation of functional annotation of genomes and transcriptome** 90  
 Automatización de la anotación funcional de genomas y transcriptomas  
 LUIS FERNANDO CADAVID GUTIÉRREZ, JOSÉ NELSON PÉREZ CASTILLO, CRISTIAN ALEJANDRO ROJAS QUINTERO, NELSON ENRIQUE VERA PARRA



**ESTUDIO DE CASO**  
**Mechanical resistance of a chemically-modified warm mix asphalt** 97  
 Resistencia mecánica de una mezcla asfáltica modificada con un aditivo químico  
 HUGO ALEXANDER RONDÓN QUINTANA, WILMAR DARÍO FERNÁNDEZ GÓMEZ



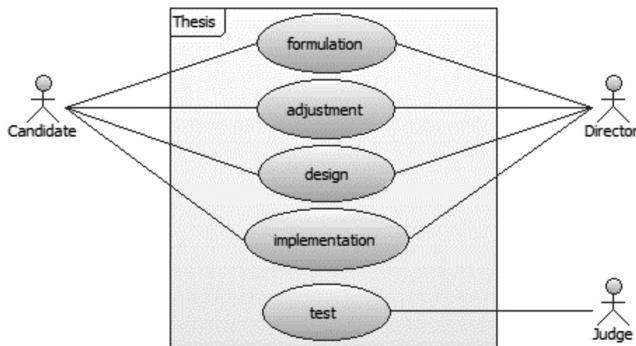
## REVISIÓN

### Development of a uml framework for smart cities with forecasting electrical consumption in Colombia

109

Desarrollo de un marco de referencia uml para ciudades inteligentes con predicción de consumo eléctrico en Colombia

RICARDO ALIRIO GONZÁLEZ BUSTAMANTE, ROBERTO FERRO ESCOBAR, GIOVANNI TARAZONA BERMÚDEZ

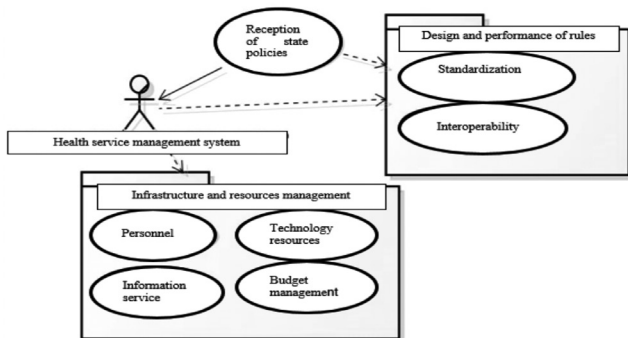


### Pedestrian systems design

124

Diseño de los sistemas peatonales

LINDSAY ÁLVAREZ POMAR, GERMÁN MÉNDEZ GIRALDO, NATÁLIA MARTINS GONÇALVES



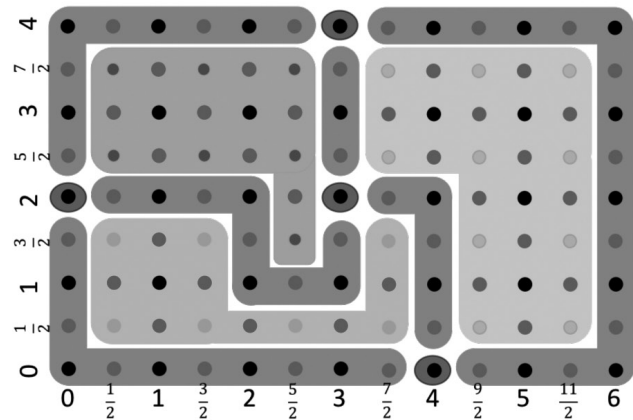
## REFLEXIÓN

### Topological challenges in multispectral image segmentation

136

Retos topológicos en la segmentación de imágenes multiespectrales

JOSÉ ANTONIO VALERO MEDINA, IVÁN ALBERTO LIZARAZO SALCEDO, PAUL ELSNER

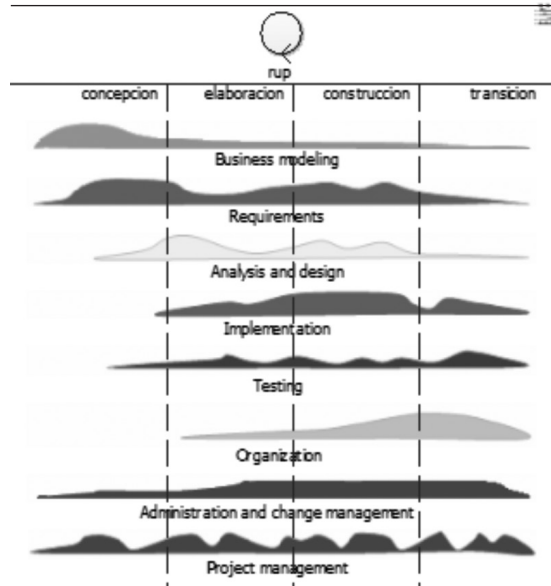


### Software engineering as a vehicle for water resources environmental planning

150

La ingeniería de software como vehículo para la planificación ambiental hídrica

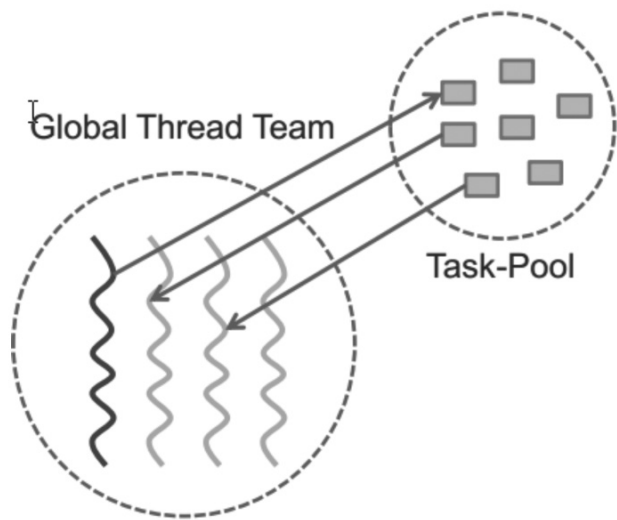
JUAN PABLO RODRÍGUEZ MIRANDA, SANDRO JAVIER BOLAÑOS CASTRO, CESAR AUGUSTO GARCÍA UBAQUE



<b>Parallel programming languages on heterogeneous architectures using openmpc, ompss, openacc and openmp</b>	<b>160</b>
Lenguajes para programación paralela en arquitecturas heterogéneas utilizando openmpc, ompss, openacc y openmp	
ESTEBAN HERNÁNDEZ B., GERARDO DE JESÚS MONTOYA GAVIRIA, CARLOS ENRIQUE MONTENEGRO	

<b>Integration model for health services in the colombian social security system</b>	<b>171</b>
Modelo de integración de servicios de salud del sistema de seguridad social colombiano	
LILIA EDITH APARICIO PICO, PEDRO ARCO RÍOS, ALEXANDRA LÓPEZ SEVILLANO	

<b>Instrucciones para los autores</b>	<b>183</b>
<b>Instructions for authors</b>	<b>191</b>
<b>Suscripción</b>	<b>199</b>
<b>Sign Up</b>	<b>200</b>



En esta edición especial de *Tecnura*, dedicada al Doctorado en Ingeniería de nuestra universidad, se hace pertinente una reflexión sobre el estado actual de los doctorados en Colombia.

Los programas de doctorado en las universidades colombianas son relativamente recientes. De acuerdo con el Ministerio de Educación Nacional, solamente existían seis programas de este tipo en 1990, mientras que en 2002 ya se contaba con 34. En los últimos años se ha registrado un aumento considerable, llegando a 197 programas en 2013, y 226 para 2014, según datos del Consejo Nacional de Acreditación (CNA). La cantidad de estudiantes que cursan estos doctorados también ha aumentado de manera importante en los últimos años; mientras en 2011 aparecían registrados 2.920 estudiantes en todo el país, a finales de 2013 la cantidad ascendió a 3.467.

Si bien estas cifras son alentadoras y vienen en aumento, el estado actual de los doctorados en Colombia presenta características particulares que llaman la atención y que vienen siendo analizadas en diferentes instancias, dentro de las que se pueden mencionar las siguientes:

A pesar del creciente número de estudiantes, todavía son pocos quienes culminan el doctorado, pues entre 1990 y 2012 solo se graduaron 1.250 de las universidades colombianas.

La mayoría de los graduados provienen de las mismas universidades donde ya trabajaban.

De la cantidad de graduados, el 51% de los nuevos doctores trabaja en Educación Superior, bien sea porque han mantenido el vínculo laboral que ya tenían al momento de iniciar sus estudios doctorales, o porque se han vinculado a universidades antes de terminar sus programas o después de graduados.

Además de los que se emplean en instituciones educativas, una gran porción dice trabajar como consultor o investigador independiente, o no tiene ingresos. Solo una mínima parte labora en la administración pública cuando se gradúa.

Si bien las políticas trazadas han dado lugar al aumento del número de doctores, y cada vez más universidades tienen programas doctorales, unas pocas concentran la mayor cantidad de ellos.

El número de doctores colombianos sigue siendo muy bajo comparado con la mayoría de países de la región con características de desarrollo similares a nuestro país.

Actualmente, 43 universidades colombianas cuentan con programas de doctorado, pero seis de ellas agrupan 126 de los 226 que existen. La Universidad Nacional cuenta con 57, la Universidad de Antioquia 24, la Universidad de los Andes 15, la Universidad del Valle 13, la Universidad del Norte 10 y la Universidad Javeriana 7 programas. Las restantes 37 universidades agrupan los otros 100 programas.

En cuanto al número de doctores que se gradúan al año en la región, durante 2011, según el portal de noticias de la Universidad Nacional, Brasil registró 12.217 graduados. Le siguió México con 4.665, Argentina con 1.680, Cuba con 1.235, y Chile con 514. Colombia registró 245 graduados y solamente superó a Costa Rica que, según el reporte, tuvo 112.

A pesar del aumento de los programas de doctorado que se ofrecen en el país y del número de estudiantes que los cursan, nuestros indicadores se encuentran muy por debajo de otros países latinoamericanos, y mucho más con respecto a algunos países desarrollados que registran el número de doctores que se gradúan anualmente por cada millón de habitantes. Según el mismo medio, en 2012 Portugal graduó 152 doctores, España 173, Estados Unidos 156, Australia 240 y el Reino Unido 259. Se menciona también que para 1930, el número de doctores por millón de habitantes en Estados Unidos era mayor al índice colombiano actual de 130 doctores por millón de habitantes en total. Sobre este aspecto, es importante anotar que esta situación obedece en gran medida a que

el país incursionó tarde en este tipo de formación, según explican los mismos investigadores.

El Estado ha reconocido que sin doctores que conformen redes de conocimiento articuladas con los diferentes sectores de la economía, no es posible lograr una gran transformación productiva en Colombia; por tanto, se requiere redoblar esfuerzos gubernamentales y del sector privado para alcanzar los objetivos trazados. Nuestro país se ha fijado como meta formar 20.000 doctores para 2034 y crear 16 centros de investigación de alto nivel para ese mismo año. Según el Ministerio de Educación Nacional, con las proyecciones de crecimiento de los programas en curso y los que se encuentran en proceso, se espera que para 2018 existan 7.126 docentes investigadores con título de doctorado, 12.624 para 2024. La meta para el año 2034 es contar con 26.695 doctores en el país.

Finalmente, aunque los resultados obtenidos hasta ahora en Colombia en materia de formación doctoral son discretos, y estos son apenas el

comienzo de un largo camino de la política de formación doctoral, para el país ya son evidentes los retos que trae consigo a nuestras universidades la formación de este nivel en cuanto a su capacidad institucional en materia de equipamiento, infraestructura y recurso humano, la internacionalización, la acreditación y la sostenibilidad en el mediano y largo plazo de los programas doctorales. Aun así, está el reto tal vez mayor: la inserción de los doctores formados en nuestras universidades dentro de los diferentes sectores económicos de la vida nacional.

Roberto Ferro Escobar  
Director Doctorado en Ingeniería

Cesar Augusto García Ubaque  
Director Revista Tecnura



## EDITORIAL

---

In this special edition of *Tecnura Journal*, which is devoted to the Doctorate in Engineering of our university, it is pertinent a reflection on the current state of doctorates in Colombia.

We may initially point out that doctorate programs in the Colombian universities are relatively new. According to the National Ministry of Education, in 1990 there were only six programs of this type, while in 2002 we already had 34. In the last years a considerable rise has been registered, reaching 197 programs in 2013 and 226 in 2014, according to data from the National Accreditation Council. The amount of students that take these doctorates in our country has increased significantly in the last years; while in 2011 were registered 2.920 doctorate students in the whole country, at the end of 2013 the amount of students rose to 3.467.

While these encouraging numbers have been increasing, the current state of the doctorates in Colombia presents particular characteristics that draw attention and that have been analyzed in different aspects, out of which we can mention the following:

Despite the rising number of students, few of them actually culminate the doctorate, since between 1990 and 2012 only 1.250 doctors were graduated from the Colombian universities.

Most graduates come from the same universities where they work at.

Out of the graduates, 51% of the new doctors are working in higher Education, either because they have maintained the labor relationship, or because they linked to universities before ending their studies or after their graduation.

Besides those employed in educational institutions, a big amount states to work as consultant or independent researcher, or they do not have incomes. Only a minimal part works in public administration when they graduate.

Although the designed policies have made room to the increase in the number of doctors, and there are progressively more universities having doctorate programs, a few concentrate most part of those.

The amount of Colombian doctors is still very low compared with most of the countries in the region that hold similar development characteristics with our country.

Currently, 43 Colombian universities have doctorate programs, but six of them group 126 out of the 226 existing. Universidad Nacional has 57, Universidad de Antioquia 24, Universidad de los Andes 15, Universidad del Valle 13, Universidad del Norte 10, and Universidad Javeriana 7 programs. The remaining 37 universities group the other 100 programs.

In terms of the number of graduating doctors every year in the region, during 2011, according to the news site of Universidad Nacional, Brazil registered 12.217 graduates. Followed by Mexico with 4.665, Argentina with 1.680, Cuba with 1.235, and Chile with 514. Colombia registered 245 graduates and only overtook Costa Rica which, according to the report, had 112.

Despite the increase of the doctorate programs offered in the country and the number of students taking them, our indicators are below related to other Latin-American countries; and even lower in respect to other developed countries that register the number of graduate doctors every year per million inhabitants. According to this same source, in 2012 Portugal graduated 152, Spain 173, United States 156, Australia 240 and the United Kingdom 259. It is also mentioned that, in 1930, the number of doctors per million inhabitants in the United States was larger than the current Colombian index with 130 doctors per million inhabitants in total. On this aspect, it is important to remark that this situation is the result of the late entrance of the country in this type of formation, as noted by the same researchers.

The State has admitted that without doctors to create knowledge networks assembled to the different sectors of the economy, it is not possible to achieve a great productive transformation in Colombia; and it is required to double governmental and private sector efforts in order to reach the established objectives. Our country has set as its goal to educate 20.000 doctors by 2034 and create 16 high-standards research centers by that year. According to the National Ministry of Education, with the growth projections for current programs and those in process, it is expected that in 2018 there will be 7.126 teacher-researchers with a doctorate, 12.626 for 2024. The goal for year 2034 is having 26.695 doctors in the country.

Finally, though the results obtained so far in Colombia in terms of doctoral formation are discrete,

and those are barely the beginning of a long road in their policies, for Colombia it is already evident the challenges that bring along to our universities the formation in this level regarding the institutional capacity in matters of equipment, infrastructure and human resources, internationalization, accreditation and sustainability in the mid and long term of doctorate programs. Even so, maybe there is the greater challenge that means the insertion of doctors educated in our universities inside the different economical sectors of the national life.

Roberto Ferro Escobar  
Director Doctorado en Ingeniería

Cesar Augusto García Ubaque  
Director Revista Tecnura

## Decision-making model for the development of productive capacity as a component of a knowledge management system

### Modelo de toma de decisiones para el desarrollo de la capacidad productiva como un component de un sistema de gestión de conocimiento

César Amílcar López Bello\*, Victor Hugo Medina García\*\*, Lorna Udden\*\*\*

**Fecha de recepción:** June 10th, 2014

**Fecha de aceptación:** November 4th, 2014

**Citation / Para citar este artículo:** López Bello, C. A., Medina García, V. H., & Udden, L. (2014). Decision-making model for the development of productive capacity as a component of a knowledge management system. *Revista Tecnura*, 18 (Edición especial doctorado), 16–29. doi: 10.14483/udistrital.jour.tecnura.2014.DSE1.a01

#### ABSTRACT

This paper presents a model of mixed integer programming optimization, used to the management and development of productive capacity; it is also used for planning and formulation of strategies for expanding and adjusting organizational activities in the medium and long term.

The model constitutes an element of organizational intelligence and is part of the system of decision support; it provides a tool for analysis and processing of information and help decision-makers to act in an efficient and effective way to solve development problems of productive capacity.

Furthermore, in the article to assess the relevance and consistency of the model presents a prototype manufacturing organization in a scenario that requires the development of capacity in terms of growth in demand for goods and services offered.

**Keywords:** Business Intelligence, Capacity Management, Decision Support System, Knowledge Management System.

#### RESUMEN

En este trabajo se presenta un modelo de optimización de programación entera mixta, que se utiliza para la gestión y desarrollo de la capacidad productiva; además, se utiliza para la planificación y la formulación de estrategias de ampliación y ajuste de las actividades de la organización en el mediano y largo plazo. El modelo constituye un elemento de la inteligencia organizacional y es parte del sistema de apoyo a las decisiones; proporciona una herramienta para el análisis y procesamiento de la información y ayuda para actuar y tomar decisiones de una manera eficiente y eficaz al resolver problemas de desarrollo de la capacidad productiva.

**Palabras clave:** gestión de la capacidad, inteligencia de negocios, sistema de gestión de conocimiento, sistema de apoyo a la toma de decisiones.

\* Industrial Engineer, Specialization in production engineering, Master of industrial engineering professor Faculty of Engineering. District University Francisco José de Caldas (Bogotá, Colombia). Contact: clopezb@udistrital.edu.co

\*\* Systems Engineer, Specialization in Marketing, MSc in Information Technology, MSc in Management of Web sites, PhD. in Computer Engineering Professor and Director of the Extension Unit of the Faculty of Engineering District University Francisco José de Caldas (Bogotá, Colombia). Contact: vmedina@udistrital.edu.co

\*\*\* B. Sc. (Hons) Computer Science, B.A. (open) (Open University), PhD. "Courseware Engineering Methodology for Technology-based Learning" Emeritus Professor of Information Technology System Staffordshire University (Staffordshire, UK). Contact: L.Uden@staffs.ac.uk

## INTRODUCTION

The development of organizations producing goods and services in a highly competitive environment depends directly on their ability to make decisions, so it is essential to equip companies with intelligence.

Other features of a learning organization include its ability to adapt to the conditions offered by the environment as well as its promptness to quickly react to the trends and behavior of a changing and highly competitive market.

Providing an organization with intelligence involves creating an infrastructure for companies to develop and sustain within a competitive environment. To this end, organizations must adopt organizational learning models that promote and ease the flow of knowledge to support the efficient and effective accomplishment of organizational actions and decisions.

The infrastructure requires integration of a Decision Support System (DSS) as well as of a knowledge management system to deploy both individual and collective capabilities towards building organizational capabilities.

The construction of decision support systems built from an integral (holistic) approach constitutes an information processing device that allows the generation of knowledge, which, in turn, clarifies and guides the decision-making process.

The purpose of a decision support system is to provide analysis tools and also lay the foundations (information and structure) for management solving problems in organizations producing goods and services.

To describe the role of decision-making processes based on a Decision Support System (DSS), a model developed herein is proposed (Figure 1).

The process starts in a first stage that consists of defining the system. This definition establishes the constituent components from observation and analysis.

The second stage consists of representing the real system and its problems using models. In this stage, different models may arise since system can be represented in several ways.

The fundamental building blocks that constitute DSS include the nature of the models (which can be qualitative and quantitative), the selection of tools for the treatment of information, the training of analysts and highly trained staff to deal with decision-making processes, and the knowledge embedded in different organizational actors as well as in the organization as a whole.

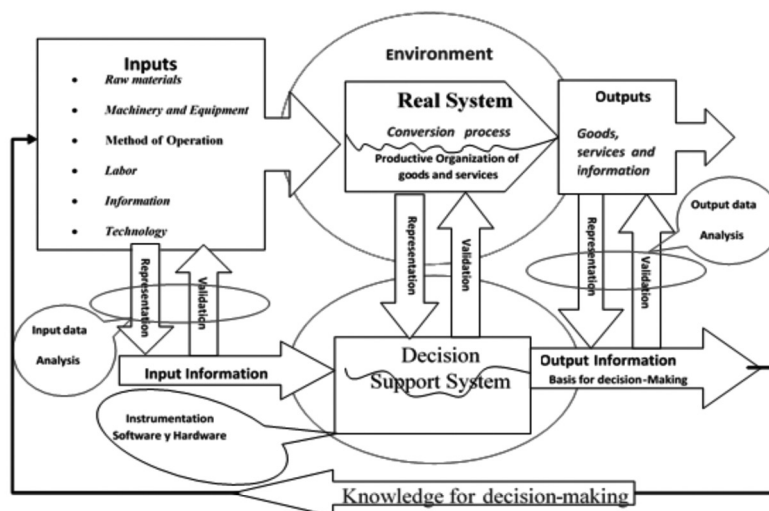
The third step consists of various tasks, namely identification of sources of data generation, establishment of corresponding data-capture processes, identification of data-analysis tools, and an evaluation of data validity in order to build the input data to feed the DSS models.

The fourth step involves determining the other inputs required to structure the DSS, namely the tangible inputs such as algorithms, computational tools (software and hardware) and an estimate of the capabilities required by analysts and decision makers.

The fifth step focuses on the design of the information-converting process in the DSS, that is, how to experiment and how to operate in order to produce base knowledge for decision-making (this requires setting scenarios and formulating strategies and alternative solutions).

Building upon the output information, the sixth stage assesses the feasibility and validity of information against the performance characteristics of the real system. To this end, it is necessary to understand the operation and behavior of the real system and also have capacity to assess the impact of a decision on the organization as a whole and on its immediate surroundings.

The seventh step is intended to provide knowledge for the decision maker to act with wisdom during the decision making process, having a positive impact on the organization.



**Figure 1.** Decision Support System Interaction

Source: Own work

Enough capacity must be allowed for the organization and for people in different dimensions for them to act successfully in an integrated and dynamic way.

The ultimate goal then is to develop methodological processes oriented towards acquiring the necessary skills (capabilities) to make an organization quick and agile when facing decision-making processes as a response to the trends governing the current knowledge-based global economy.

A broader perspective shows how the output information and its corresponding validation build knowledge. This knowledge together with the accumulated knowledge, the interaction with the environment and the training processes integrate as a knowledge management system to support decision-making.

## CAPACITY EXPANSION MODEL

One of the stated requirements, on the way to improve the competitiveness of organizations, is the adoption of a proper trading strategy, which is defined for Roger Schroeder (2012), Abdul-Jalal, Toulson, & Tweed (2013) as a view of the operations

function that depends on direction or general impetus for decision-making. This vision must be integrated with business strategy and often, but not always, reflected in a formal plan.

The operations strategy should result in a consistent pattern of decision-making and operations and a competitive advantage for the company. Likewise, (Ahmad, Bosua, & Scheepers, 2014), (F. Jacobs, 2010), expressed as an important aspect to consider, that this strategy should specify how the company will use their productive capacities to support the corporate strategy. All this means that operations strategy must emerge from a long term business strategy and, in turn, must be integrated horizontally with the strategies of the other subsystems of the company.

According to this statement and in accordance with (Babnik, Širca, & Dermol, 2014), (Machuca, 1995.), the operations strategy is established as a long-term plan for the operations subsystem, which are set to achieve the objectives and courses of action and allocation resources to different products and features.

This should pursue the achievement of the overall objectives of the company as part of its corporate



strategy and constitutes a consistent pattern for the development of tactical and operational decisions of the subsystem. This, no different from the concept of (Schroeder, 2012), who also adds that the trading strategy should be a functional strategy that should guide business strategy and whose heart must be made by the mission, the distinctive competence, objectives and policies.

The system is limited by the availability of resources and conditions imposed by the environment such as market regulation standards, environmental, social, industrial requirements, as well as the perceptions and needs of the client, now depending on management system of the organization and proper decision-making, the system shall be provided an intelligent management system that meets the needs of a demanding and dynamic market.

So to simplify the complexity from this abstraction, we propose a decision support system where in structure available models and optimization tools that provides information and analysis for decision-making at the strategic level, tactical level and operational level.

Are varied and similar approaches regarding the process of planning, scheduling and production control have been treated by several authors such as (Berends, Vanhaverbeke, & Kirschbaum, 2007; Bermell-Garcia et al., 2012), (Zhen, Song, & He, 2012), (Schroeder, 2012), (Tawfik, 1992.), (S. Nahmias, 2009), (Riggs, 1987), (Buffa, 1987), (Jack R. Meredith, 2012) among others, who established, in general terms, that starts with forecasts, from which emerge the plans long, medium and short term. According to the authors, this approach presents some shortcomings, as it lacks the integrative concept in the vertical direction, should start in business strategy, and in the horizontal direction, must interact with the other subsystems of the organization.

Other authors such as (Starr, 1979), (R. Companys Pascual, 1989), and (Jacobs, 2010), (Ebert, 1991), offer models of production management that, despite establishing an integrative concept

in the vertical, not clearly express the integration horizontally. Maybe they are F. Jacobs (2011), and F. Robert Jacobs (2010), (Machuca, 1995), who, according to the literature, have a better approach, believing integration in both directions. In this regard, the latter author states that the planning and control of production should follow a hierarchical approach, which is achieved vertical integration between the strategic, tactical and operational and also set its horizontal relationship with other functional areas of the company.

The main input of information for decision-making in any organization of production of goods and services is originating from the knowledge of the nature of demand and their patterns of behavior and, based on this knowledge, will determine the resources required to ensure supply efficiently and achieve effectively the goals of the organization.

If the products and services offered have long life cycles and innovation is relatively easy to modify (e.g. presentation, color, size and other qualities that point to customer perception), then from the availability of historical data can be projected demand; however, if the projected demand is growing and perceived needs for increased capacity, it follows that it is necessary to plan the development of capacity at the level strategic and tactical. According to (Lopez B., 2006) in the medium term an analyze the feasibility of increasing the available capacity with scheduling overtime or scheduling new shifts, or definitely is required purchase of new plant and equipment that fill the future needs, here you should think and projector offering new products and services, as discussed in (Lopez B., 2006)

This model aims to assess the technical and economic feasibility of expanding the installed capacity, the best way to use resources, enabling scheduling tree shifts or overtime, whether to increase capacity at each stage of the process and in each point in time, it is noteworthy that the decision to schedule machines in two or three shifts, or overtime for each stage of the process involves additional fixed costs for each recommended

decision, and consider additional costs for amortization of the purchase of the new machinery and equipment, and hiring new workers. Then the objective function is structured in terms of production and inventory levels in the decision to buy new machinery and equipment, in the decision to schedule one, two, three shifts or overtime for each process step in each time period and the number of workers required to handle new equipment in those extra shifts and new facilities. Then the production function of the capacity expansion with three levels of economies of scale and overtime is denoted by the equation (1) and is expressed in the equation (2).

*Objective:* Determine a plan to expand the installed capacity, programming new work shifts or overtime scheduling, oriented utility maximization and expansion of installed capacity.

#### Objective Function:

$$F = f(X_{j,t}, X_{j,t}^{(3)}, X_{j,t}^{(e)}, I_{j,t}, Oc_t, Y_i, W_{i,t}, Z_{i,t}, \lambda_{i,t}, X_{j+i,t}, X_{j+M+1,t}) \quad (1)$$

$$F = \sum_{t=1}^T \sum_{j=1}^J (p_j - c_j) X_{j,t} + \sum_{t=1}^T \sum_{j=1}^J (p_j - c_j^{(3)}) X_{j,t}^{(3)} + \sum_{t=1}^T \sum_{j=1}^J (p_j - c_j^{(e)}) X_{j,t}^{(e)} - \sum_{t=1}^T \sum_{j=1}^J h_{j,t} I_{j,t} - \sum_{t=1}^T \sum_{i=1}^M CFA_{i,t}^{(2)} W_{i,t} - \sum_{t=1}^T \sum_{i=1}^M CFA_{i,t}^{(3)} Z_{i,t} - \sum_{t=1}^T \sum_{i=1}^M CFA_{i,t}^{(e)} \lambda_{i,t} - \sum_{t=1}^T A_t Y_t - CC \sum_{t=1}^T Oc_t - CF \quad (2)$$

#### Decision Variables

$X_{j,t}$ : Production level in regular time of the item "j" in the period "t" (turn one and two)

$X_{j,t}^{(3)}$ : Production level in the third shift of the item "j" in the period "t"

$X_{j,t}^{(e)}$ : Production level in the overtime of the item "j" in the period "t"

$W_{i,t}$ : Binary decision variable expressing the ability to schedule a second shift in the process stage "i" in the period "t"

$Z_{i,t}$ : Binary decision variable expressing the ability to schedule a third shift in the process stage "i" in period "t"

$\lambda_{i,t}$ : Binary decision variable expressing the ability to schedule overtime in the process stage "i" in period "t"

$We_t$ : Binary decision variable expressing the ability to schedule overtime staff in period "t"

$X_{j+i,t}$ : The Idle of the machine type "i" in regular time, in the period "t"

$X_{j+M+1,t}$ : Leisure of the workforce in regular time in the period "t"

$X_{j+M+1,t}^{(e)}$ : Leisure of the workforce in overtime in the period "t"

$X_{i,t}^{(3)}$ : The Idle of the machine type "i" in the third turn, in period "t"

$X_{i,t}^{(e)}$ : The Idle of the machine type "i" if programmed overtime in period "t"

$Y_i$ : Number of machines to acquire the type "i"

$Oc_t$ : Number of new workers to hire (multipurpose), in the period "t"

$I_{j,t}$ : Inventory on hand at end of period "t" of the product type "j"

$dn_{j,t}$ : Unmet demand for product type "j" in period "t"

$Y_{i,t}^{(2)}$ : New machines of type "i" to program in the second turn in period "t"

$Y_{i,t}^{(3)}$ : New machines of type "i" to program in the third turn in period "t"

$Y_{i,t}^{(e)}$ : New machines of type "i" to program in the

$Oc_t^{(e)}$ : Operators new to programming in overtime in period "t"

#### Parameters:

$C_j$ : Unit production cost in regular time (turns one and two) of the article type "j"

$C_j^{(3)}$ : Unit production cost of the article type "j" if it occurs in the third turn

$C_j^{(e)}$ : Unit production cost of the Item type "j" if it occurs in overtime

$P_j$ : Sale price per unit of product type "j"

$CF$ : Fixed Cost

$dmax_{j,t}$ : Potential Demand of the Product type "j" in the period "t"

$dmin_{j,t}$ : Demand required of the Product type "j" in the period "t"

$Cd_{i,t}^{(1)}$ : Available capacity in one turn of the machinery in the process step "i" scheduled in the period "t"

$Cd_{i,t}^{(2)}$ : Additional available capacity machine in the process step "i" if a second shift is scheduled in the period "t"

$Cd_{i,t}^{(3)}$ : Additional available capacity machine in the process step "i" if a third shift program is scheduled in the period "t"

$Cd_{i,t}^{(e)}$ : Additional available capacity machine in the process step "i" if scheduled overtime in the period "t"

$Cdu_{i,t}^{(1)}$ : Available capacity for unit of machine in the process step "i" if the first shift is scheduled in the period "t"

$Cdu_{i,t}^{(2)}$ : Additional available capacity for unit of machine in the process step "i" if a second shift is scheduled in the period "t"

$Cdu_{i,t}^{(3)}$ : Additional available capacity for unit of machine in the process step "i" if a third shift program is scheduled in the period "t"

$Cdu_{i,t}^{(e)}$ : Additional available capacity for unit machine in the process step "i" if scheduled overtime in the period "t"

$Kd_t$ : Available capacity of manpower resource in regular time in the period "t"

$Kde_t$ : Available capacity of manpower resource in overtime in the period "t"

$Kdo_t$ : Available capacity per worker in regular time in the period "t"

$Kdoe_t$ : Available capacity for operator if scheduled overtime in the period "t"

$a_{i,j}$ : Standard processing time of a product type "j" in a machine in the process stage "i"

$b_{i,j}$ : Runtime labor required per unit of product type "j" in the process step "i"

$CC$ : Cost of recruitment, hiring and training a new operator.

$h_{j,t}$ : Inventory carrying cost per unit of product type "j" in the period "t"

$CFA_{i,t}^{(2)}$ : Additional costs for increased production levels to schedule a second shift in the process step "i" in the period "t"

$CFA_{i,t}^{(3)}$ : Additional costs for increased production levels to program a third shift in the process step "i" in the period "t"

$CFA_{i,t}^{(e)}$ : Additional costs for increased production levels by scheduling overtime in the process step "i" in the period "t"

$A_i$ : Amortized cost for the purchase, installation and commissioning of a machine type "i"

$Er_i$ : Space required for installation of a new machine, considering the work areas: raw material supply, equipment handling and temporary storage of processed product in the process step "i"

$Ed$ : Available space for installation of new equipment.

$f_s$ : Service factor

#### Initial Conditions:

$I_{j,0}$ : Inventory on hand at the beginning of the planning period of product type "j" (so that it is equal to a constant) where,

#### Referential Sets:

$i$ : Index that identifies the step of the process and type of machine, where

$j$ : Index that identifies the type of product, where

$t$ : Index that identifies the production period, where

$M$ : Number of process stages or types of machine

$J$ : Number of product types

$T$ : Number of periods of planning horizon

#### Constraints:

The model of expansion of installed capacity, with three levels of economy of scale for strategic and tactical decisions, scheduling three shifts and possibility of scheduling overtime, includes the following restrictions:

*Restricting resource capacity machine and equipment for two turns*, in it takes into account the possibility of increasing capacity with the purchase and installation of new equipment, if used one shift, or two shifts which is activated with binary variable associated with this possibility, the restrictive condition is further capacity in regular time (turn one two).

So that the required capacity more leisure slack resource means equals machine capacity available

in regular time increased with the possibility of activating the second shift and increased capacity with the purchase and implementation of new places of work, as shown in the equation (3).

$$\sum_{j=1}^J a_{i,j} X_{j,t} + X_{j+i,t} - Cd_{i,t}^{(2)} W_{i,t} - Cdu_{i,t}^{(1)} Y_i - Cdu_{i,t}^{(2)} Y_{i,t}^{(2)} = Cd_{i,t}^{(1)} \quad \forall i \wedge \forall t \quad (3)$$

*Restriction of production capacity the third shift*, this restriction is indicating the possibility of using the turn three in production, where the additional capacity is activated with a binary variable that enables third shift, and the increase caused by the purchase and installation of new machinery and equipment, as shown in equation (4).

$$\sum_{j=1}^J a_{i,j} X_{j,t}^{(3)} + X_{j+i,t}^{(3)} - Cd_{i,t}^{(3)} Z_{i,t} - Cdu_{i,t}^{(3)} Y_{i,t}^{(3)} = 0 \quad \forall i \wedge \forall t \quad (4)$$

*Restriction machine capacity in overtime*, where the capacity is related to the production employed in overtime, limited by the availability of programmable machine time in overtime, which is activated by a binary variable, and consider the possibility of using the additional capacity for the acquisition, installation and qualification of new machinery and equipment, as expressed in the equation (5).

$$\sum_{j=1}^J a_{i,j} X_{j,t}^{(e)} + X_{j+i,t}^{(e)} - Cda_{i,t}^{(e)} \lambda_{i,t} - Cdu_{i,t}^{(e)} Y_{i,t}^{(e)} = 0 \quad \forall i \wedge \forall t \quad (5)$$

*Restriction of human resource capacity*, here relates the required capacity of labor in three shifts, with available capacity associated with the current workforce and the ability to be increased by hiring new workers, which implies an increase capacity of labor. This relationship is shown in the equation (6).

$$\sum_{j=1}^J \sum_{i=1}^M b_{i,j} X_{j,t} - \sum_{j=1}^J \sum_{i=1}^M b_{i,j} X_{j,t}^{(3)} - Kdoe_t \sum_{r=1}^t Oc_r + X_{j+M+1,t} = Kd_t \quad \forall t \quad (6)$$

*Capacity constraint of manpower resource in overtime*, this restriction associated personnel scheduling decision in overtime, provided that overtime is enabled, this option is included in

addition to the new hires. This relation is represented by the equation (7).

$$\sum_{j=1}^J \sum_{i=1}^M b_{i,j} X_{j,t}^{(e)} - Kdoe_t \sum_{r=1}^t Oc_r^{(e)} + X_{j+M+1,t}^{(e)} = Kde_t we_t \quad \forall t \quad (7)$$

*Potential demand constraint*, this relationship is expressed with the limits imposed by the market and indicates that the levels of the production and inventory should not exceed the projected potential demand; we see that the difference between demand and supply is unmet demand. This relation is represented by the equation (8).

$$X_{j,t} + X_{j,t}^{(3)} + X_{j,t}^{(e)} + I_{j,t-1} - I_{j,t} + dn_{j,t} = dmax_{j,t} \quad \forall j \wedge \forall t \quad (8)$$

*Restriction required demand*, this relation is expected to ensure compliance with the requirements demanded of each product at each point in time, using the methods of production in regular time, a third shift schedule or overtime scheduling. These requirements can obey to commitments made to customers or policy of level of customer service and is expressed as the equation (9). It is guaranteed that actual production levels in regular time, in the third shift and in overtime, and initial inventory level available minus the end inventory in each period for each product should be greater than or equal to the minimum required demand.

$$X_{j,t} + X_{j,t}^{(3)} + X_{j,t}^{(e)} + I_{j,t-1} - I_{j,t} \geq dmin_{j,t} \quad \forall j \wedge \forall t \quad (9)$$

*Restriction service level*, it is intended to enable a condition to ensure a level of customer service, is used if there is a policy difference between service level with demand required when there are commitments to customers. It indicates unmet demand should be inferred at a fraction of the potential demand, as shown in the equation (10).

$$dn_{j,t} \leq (1 - fs)dmax_{j,t} \quad \forall j \wedge \forall t \quad (10)$$

*Restriction of physical space*, this condition limits the ability to purchase and install new machinery and equipment, depending on the availability

of space for installation of new jobs; on the left shows that the sum of the multiplication between the number of machines with the space for installation and operation for each unit type machine should not higher availability of physical space, as seen in equation (11).

$$\sum_{i=1}^M Er_i Y_i \leq Ed \quad (11)$$

*Zero profit constraint*, this relationship is specified that the income generated by production levels made in one, two and three shifts and the overtime, less the costs associated with inventory levels, and involve additional costs programming of the second, third shift and overtime, plus costs for a return on investment for the purchase and installation of new machinery and equipment costs exceed fixed programmed for the operation of the organization and is expressed by the equation (12).

$$\sum_{t=1}^T \sum_{j=1}^J (p_j - c_j) x_{j,t} + \sum_{t=1}^T \sum_{j=1}^J (p_j - c_j^{(2)}) x_{j,t}^{(2)} + \sum_{t=1}^T \sum_{j=1}^J (p_j - c_j^{(3)}) x_{j,t}^{(3)} - \sum_{t=1}^T \sum_{j=1}^J h_{j,t} I_{j,t} - \sum_{t=1}^T \sum_{i=1}^M CFA_{i,t}^{(2)} W_{i,t} - \sum_{t=1}^T \sum_{i=1}^M CFA_{i,t}^{(3)} Z_{i,t} - \sum_{t=1}^T \sum_{i=1}^M CFA_{i,t}^{(e)} \lambda_{i,t} - \sum_{t=1}^T A_t Y_t - CC \sum_{t=1}^T O_{c_t} \geq CF \quad (12)$$

Equation (13) expresses the impossibility of programming simultaneously the third shift with the overtime. This expression is conditioned with the addition of binary variables.

$$Z_{i,t} + \lambda_{i,t} \leq 1 \quad \forall i = 1, 2, \dots, M \quad \forall t = 1, 2, \dots, T \quad (13)$$

With the equations (14), (15) and (16) ensures that the new machines can be programmed on the second shift, third shift or overtime provided they are purchased.

$$Y_{i,t}^{(2)} \leq Y_i \quad \forall i = 1, 2, \dots, M \quad \forall t = 1, 2, \dots, T \quad (14)$$

$$Y_{i,t}^{(3)} \leq Y_i \quad \forall i = 1, 2, \dots, M \quad \forall t = 1, 2, \dots, T \quad (15)$$

$$Y_{i,t}^{(e)} \leq Y_i \quad \forall i = 1, 2, \dots, M \quad \forall t = 1, 2, \dots, T \quad (16)$$

With the equations (17), (18) y (19) ensures that the new machines can be programmed in the respective shifts, as long as the shifts are enabled.

$$Y_{i,t}^{(2)} \leq MW_{i,t} \quad \forall i = 1, 2, \dots, M \quad \forall t = 1, 2, \dots, T \quad (17)$$

$$Y_{i,t}^{(3)} \leq MZ_{i,t} \quad \forall i = 1, 2, \dots, M \quad \forall t = 1, 2, \dots, T \quad (18)$$

$$Y_{i,t}^{(e)} \leq M\lambda_{i,t} \quad \forall i = 1, 2, \dots, M \quad \forall t = 1, 2, \dots, T \quad (19)$$

With the equation (20) ensures that the workforce should be scheduled if scheduled overtime at any stage of the process at some period

$$We_t \leq \sum_{i=1}^M \lambda_{i,t} \quad \forall t = 1, 2, \dots, T \quad (20)$$

With the equation (21) ensures that operators engaged, may be scheduled overtime long as they are engaged.

$$\sum_{r=1}^t Oc_r^{(e)} \leq \sum_{r=1}^t Oc_r \quad (21)$$

The equation (22) shows the logic condition to be non-negative and integer decision variables, number of machines has to be acquired or enabled in a turn and hired workers and qualified to work in regular time or overtime.

$$Y_i, Y_{i,t}^{(2)}, Y_{i,t}^{(3)}, Y_{i,t}^{(e)}, Oc_t, Oc_t^{(e)} \geq 0 \quad \wedge \quad integer \quad \forall i = 1, 2, \dots, M \quad \forall t = 1, 2, \dots, T \quad (22)$$

In the equation (23) are shown binary conditions for the decision to schedule a second shift, third shift or overtime in each process step in each time period and the decision to schedule the operators in overtime.

$$W_{i,t}, Z_{i,t}, \lambda_{i,t}, We_t \text{ are binary} \quad \forall i = 1, 2, \dots, M \quad \forall t = 1, 2, \dots, T \quad (23)$$

With logical equation (24), expresses the conditions of non-negativity of the variables, production levels in regular time, on the third shift, overtime, inventory levels and unmet demand.

$$X_{j,t}, X_{j,t}^{(3)}, X_{j,t}^{(e)}, I_{j,t}, dn_{j,t} \geq 0 \quad \forall j = 1, 2, \dots, J \quad \forall t = 1, 2, \dots, T \quad (24)$$

With logical equation (25), expresses the condition of non-negativity of the variables, idle



machinery, workforce in regular time, and unused capacity on a third shift or overtime.

$$X_{j+i,t}, X_{j+i,t}^{(3)}, X_{j+i,t}^{(e)}, X_{j+M+1,t}, X_{j+M+1,t}^{(e)} \geq 0 \quad \forall i = 1, 2, \dots, M \quad \forall t = 1, 2, \dots, T \quad (25)$$

*Initial conditions*, this equation (26) is specified that the inventory on hand at the beginning of the planning horizon of product type "j" is equal to a constant.

$$I_{j,0} = kte_j \quad \forall j = 1, 2, \dots, J \quad (26)$$

In equation (27) summarizes the mixed integer programming model to evaluate strategies to increase production capacity.

$$\begin{aligned} \text{Min } F = & \sum_{i=1}^T \sum_{j=1}^J (p_j - c_j) X_{j,t} + \sum_{i=1}^T \sum_{j=1}^J (p_j - c_j^{(3)}) X_{j,t}^{(3)} + \sum_{i=1}^T \sum_{j=1}^J (p_j - c_j^{(e)}) X_{j,t}^{(e)} - \sum_{i=1}^T \sum_{j=1}^J h_{j,t} I_{j,t} - \sum_{i=1}^T \sum_{j=1}^M CFA_{i,t}^{(2)} W_{i,t} \\ & - \sum_{i=1}^T \sum_{j=1}^M CFA_{i,t}^{(3)} Z_{i,t} - \sum_{i=1}^T \sum_{j=1}^M CFA_{i,t}^{(e)} \lambda_{i,t} - \sum_{i=1}^T A_i Y_i - CC \sum_{i=1}^T O c_i - CF \end{aligned} \quad (27)$$

subject to:

$$\sum_{j=1}^J a_{i,j} X_{j,t} + X_{j+i,t} - Cd_{i,t}^{(2)} W_{i,t} - Cdu_{i,t}^{(1)} Y_i - Cdu_{i,t}^{(2)} Y_{i,t}^{(2)} = Cd_{i,t}^{(1)} \quad \forall i \wedge \forall t$$

$$\sum_{j=1}^J a_{i,j} X_{j,t}^{(3)} + X_{j+i,t}^{(3)} - Cd_{i,t}^{(3)} Z_{i,t} - Cdu_{i,t}^{(3)} Y_{i,t}^{(3)} = 0 \quad \forall i \wedge \forall t$$

$$\sum_{j=1}^J a_{i,j} X_{j,t}^{(e)} + X_{j+i,t}^{(e)} - Cda_{i,t}^{(e)} \lambda_{i,t} - Cdu_{i,t}^{(e)} Y_{i,t}^{(e)} = 0 \quad \forall i \wedge \forall t$$

$$\sum_{j=1}^J \sum_{i=1}^M b_{i,j} X_{j,t} - \sum_{j=1}^J \sum_{i=1}^M b_{i,j} X_{j,t}^{(3)} - Kdo_t \sum_{r=1}^t O c_r + X_{j+M+1,t} = Kd_t \quad \forall t$$

$$\sum_{j=1}^J \sum_{i=1}^M b_{i,j} X_{j,t}^{(e)} - Kdoe_t \sum_{r=1}^t O c_r^{(e)} + X_{j+M+1,t}^{(e)} = Kde_t we_t \quad \forall t$$

$$X_{j,t} + X_{j,t}^{(3)} + X_{j,t}^{(e)} + I_{j,t-1} - I_{j,t} + dn_{j,t} = dmax_{j,t} \quad \forall j \wedge \forall t$$

$$X_{j,t} + X_{j,t}^{(3)} + X_{j,t}^{(e)} + I_{j,t-1} - I_{j,t} \geq dmin_{j,t} \quad \forall j \wedge \forall t$$

$$dn_{j,t} \leq (1 - fs)dmax_{j,t} \quad \forall j \wedge \forall t$$

$$\sum_{i=1}^M Er_i Y_i \leq Ed$$

$$\begin{aligned} \sum_{i=1}^T \sum_{j=1}^J (p_j - c_j) X_{j,t} + \sum_{i=1}^T \sum_{j=1}^J (p_j - c_j^{(3)}) X_{j,t}^{(3)} + \sum_{i=1}^T \sum_{j=1}^J (p_j - c_j^{(e)}) X_{j,t}^{(e)} - \sum_{i=1}^T \sum_{j=1}^J h_{j,t} I_{j,t} - \sum_{i=1}^T \sum_{j=1}^M CFA_{i,t}^{(2)} W_{i,t} \\ - \sum_{i=1}^T \sum_{j=1}^M CFA_{i,t}^{(3)} Z_{i,t} - \sum_{i=1}^T \sum_{j=1}^M CFA_{i,t}^{(e)} \lambda_{i,t} - \sum_{i=1}^M A_i Y_i - CC \sum_{i=1}^T O c_i \geq CF \end{aligned}$$

$$Z_{i,t} + \lambda_{i,t} \leq 1 \quad \forall i = 1, 2, \dots, M \quad \wedge \quad \forall t = 1, 2, \dots, T$$

$$Y_{i,t}^{(2)} \leq Y_i \quad \forall i = 1, 2, \dots, M \quad \wedge \quad \forall t = 1, 2, \dots, T$$

$$Y_{i,t}^{(3)} \leq Y_i \quad \forall i = 1, 2, \dots, M \quad \wedge \quad \forall t = 1, 2, \dots, T$$

$$Y_{i,t}^{(e)} \leq Y_i \quad \forall i = 1, 2, \dots, M \quad \wedge \quad \forall t = 1, 2, \dots, T$$

$$Y_{i,t}^{(2)} \leq MW_{i,t} \quad \forall i = 1, 2, \dots, M \quad \wedge \quad \forall t = 1, 2, \dots, T$$

$$Y_{i,t}^{(3)} \leq MZ_{i,t} \quad \forall i = 1, 2, \dots, M \quad \wedge \quad \forall t = 1, 2, \dots, T$$

$$Y_{i,t}^{(e)} \leq M\lambda_{i,t} \quad \forall i = 1, 2, \dots, M \quad \wedge \quad \forall t = 1, 2, \dots, T$$

$$We_t \leq \sum_{i=1}^M \lambda_{i,t} \quad \forall t = 1, 2, \dots, T$$

$$\sum_{r=1}^t O c_r^{(e)} \leq \sum_{r=1}^t O c_r$$

$$Y_i, Y_{i,t}^{(2)}, Y_{i,t}^{(3)}, Y_{i,t}^{(e)}, O c_t, O c_t^{(e)} \geq 0 \quad \wedge \quad \text{integer } \forall i = 1, 2, \dots, M \quad \wedge \quad \forall t = 1, 2, \dots, T$$

$$W_{i,t}, Z_{i,t}, \lambda_{i,t}, We_t \text{ are binary } \forall i = 1, 2, \dots, M \quad \wedge \quad \forall t = 1, 2, \dots, T$$

$$X_{j,t}, X_{j,t}^{(3)}, X_{j,t}^{(e)}, I_{j,t}, dn_{j,t} \geq 0 \quad \forall j = 1, 2, \dots, J \quad \wedge \quad \forall t = 1, 2, \dots, T$$

$$X_{j+i,t}, X_{j+i,t}^{(3)}, X_{j+i,t}^{(e)}, X_{j+M+1,t}, X_{j+M+1,t}^{(e)} \geq 0 \quad \forall i = 1, 2, \dots, M \quad \wedge \quad \forall t = 1, 2, \dots, T$$

$$I_{j,0} = kte_j \quad \forall j = 1, 2, \dots, J$$

## PROTOTYPE

### Description

Manufacturing firms pose in their strategic development plans the possibility of expanding production capacity, for which you can use strategies such as overtime scheduling, scheduling new shifts or by purchasing, installing and enabling new posts work; additionally, wish to evaluate the technical feasibility of introducing new products to the market.

The Company produces four types of product families, to over three stages of the process, where there are multiple machines (or jobs) by process step the same technology. The company works in one shift of eight hours, six days a week (Monday to Saturday), not working holidays and also collective vacation program corresponding to fifteen business days per year (seven days in December and eight days of January).

The standard processing time in minutes of each machine per unit of product type by type of machine in each process step, the number of machines available for each type of process step, standard time losses caused by the preventive maintenance of the equipment per unit of each type of machine in hours per year, the number of workers required per job or machine type, the amount of raw material required per unit of product, the cost of operating a machine each type in \$ per hour machine, the unit cost of each type of raw material, the initial inventory available for each type of product

and the selling price per unit of each product is shown in table 1.

The potential demand is calculated based on the data passed in the previous two years and shown in table 2. If they decide to schedule overtime, the cost of labor is increased by 10%, plus an increase in the fixed cost caused by the need to coordinate and monitor the additional activity, estimated at 10% with the cost fixed; in other words, the cost prorated for periods where scheduling extra time for each stage of the process (e.g. the fixed cost additional incurred in a process step in a period where program overtime is \$22.222.222 per month).

**Table 1.** Prototype parameters

	PRODUCT				Number of Machines	Losses Hour-Machine for year	Worker for machine	Operation cost \$ / hour-Machine
	Minute for unit							
STAGE	P1	P2	P3	P4				
E1	11	14	12	11	20	110	1	27380
E2	10	8	9	8	15	115	2	25870
E3	12	7	7	10	16	135	2	24750
Raw Material	P1	P2	P3	P4				\$/unit
MP1	2	2.1	2.3	2.3		Units		2600
MP2	1.5	1.2	3.8	1.9		Units		2380
MP3	20	22	25.5	26.5		Grams		165
Sale Price	43953	43022	44772	45531				\$/unit
Initial Inventory	500	250	420	285				Unit
Losses Standard for	Factors Organizational		G2	3500	hours/year			
	absenteeism		G3	3200				
	External Factors		G4	3300				

**Source:** Own work.

Also, if you set a second shift, the labor costs for the two shifts are similar, but the fixed cost increases, as well as whether overtime program., which is \$22.222.222 per month by process step where new the shift schedule. The maximum production capacity in the second round is the same as the first, also, increase the losses of time due to equipment maintenance and by several factors, but it is necessary to evaluate the hiring of new workers. You can program a third shift, but in this situation the cost of labor would increase by 25% with additional fixed costs of \$25.000.000 a month by step

process if they activate the shift. Also effective capacity at the third shift would be only 70% of the capacity of the other shifts, for efficiency and coordination reasons. For this situation it is important to evaluate the hiring of new workers.

The company has a staff of 96 multipurpose workers, the labor time involved an additional 20% for material handling and equipment enlistment. The cost of labor is determined by the salary of each employee which are semi-skilled and up to two statutory minimum wage.

**Table 2.** Demand data for the last two years of the products

Period	DEMAND FOR PRODUCT							
	P1		P2		P3		P4	
	Year 1	Year 2	Year 1	Year 2	Year 1	Year 2	Year 1	Year 2
January	10500	10510	9500	9510	10300	10210	5500	5510
February	11550	11420	9550	9820	11550	11420	6550	6420
March	13280	13300	8280	8300	8500	8800	6280	6300
April	14440	14560	12440	12570	10440	10560	7440	7560
May	15300	15600	13300	13680	8300	8600	10300	10600
June	16200	16450	15210	15420	9200	9450	12200	12450
July	13200	13250	16200	16250	10200	10250	15200	15240
August	12620	12300	15330	15380	12620	12300	16620	16300
September	14540	14640	14730	14720	13540	13640	17540	17640
October	15200	15600	14200	14640	17200	17600	17200	17600
November	15600	15820	15700	16620	18500	18820	18600	18820
December	16400	16920	16800	17320	20400	20920	19400	19920

Source: Own Work

The annual fixed cost of operating the business without considering any expansion, hiring costs, depreciation costs for the purchase, acquisition and installation of new equipment, the area required for the installation and operation of a machine of each type and the area available for the placement of new jobs are shown in table 3.

**Table 3.** Additional data to assess the capacity expansion

Machine	Amortized Cost \$/year	Required Space for machine m <sup>2</sup>
M1	4.200.000	6
M2	4.800.000	8
M3	5.600.000	10
Available Space 820 m <sup>2</sup>		
Cost of hiring 1.200.000 \$/worker		
Fixed Cost 1.500.000.000 \$/year		

Source: Own work

The inventory carrying cost is charged 2% monthly average inventory at cost (2% per month for the unit cost of the product).

### Solution and Experimentation

1. To solve the problem is to construct the information needed by treating the input feature data, then calculate required.

- Production capacity of the machinery by step process in each time period in regular time (one shift, two shifts, three shifts) and in overtime.
- Machine per unit capacity of each type.
- Labor capacity.
- Projected demand over the planning horizon.
- Operating costs, labor costs and material costs.

2. Software requirements: using GAMS (General Algebraic Models System)

### Testing and Simulations

The number of experiments that can be performed directly dependent on the configuration of the organization and its features, and the scope of the

decision, if you think about evaluating the possibility of expanding the capacity available with strategies such as scheduling more shifts or scheduling overtime, or if the decision is strategic and is planning to expand the installed capacity, with the purchase and installation of new machines and jobs. Then, from the experiments are located bottlenecks resources and is observed as determining the best decisions to modify the availability of resources, for example the space available for installation of new machines. It should be noted that the decision process requires the ability of the decision-maker in terms of understanding of the issues and the knowledge and use of decision support tools, as well as the agility to the analysis and interpretation of results and their validity face the facts presented in the organizational system.

#### *Changes in demand requirements*

To the extent that the problem is not restricted to minimum demand, the contribution margin increased to the detriment of the non-production of goods with lower profitability.

If the company wants to meet the demand must increase capacity; in other words, if the problem is conditioned to meet minimum demands, more capacity is needed, now limited to the production system, the alternative is to produce with strategies such as overtime or programming a third shift to be far more costly to the detriment of the utility.

#### *Changes in the availability of physical space*

If the possibility of installing new equipment due to lack of physical space is restricted, the development of the capacity for what this resource is seen as the limiting or bottleneck that limits the growth and development of productive capacity is truncated. But if the physical space, for example to 1200 square meters for the installation of new equipment and workstations increases, growth in income and resource use more widely seen, so it looks like it absorbs and holds demand.

#### *Changes in costs*

Unit costs may grow by the increase in the value of raw materials, the cost associated with labor and operating costs, in addition, inventory carrying costs will increase or decrease depending on the value of the goods. Additionally the costs of preparation and readiness, replacement costs lots in the sequence of operations are crucial to productive activity and influence the preference for the production of a good or another.

#### *Price Changes*

The selling price of the products varies with time and depends directly on its life cycle, in addition to regulations imposed by trade and free market competition.

It is perceived that increasing the price of a product contribution margin increases and therefore there is a tendency to prioritize the production of goods; on the other hand, if the price drops, it tends to decrease activity levels for production of this article.

#### *Add other resource constraints*

It is important to note that the dynamics and growth of organizations may be affected and limited by the scarcity of resources as the raw material that definitely changes the action plans and the distribution of production activities of goods and services. The production of pollutants and stabilize the environment are critical in the decision process, generating restrictive elements to productive activity. Then it is necessary to add relationships restrictive model that take into account these limitations. It is understood that any restriction that limits on corporate actions caused losses in the profit margin, and any additions and obtaining resources bottlenecks do to increase profits.

## **CONCLUSIONS**

The system decision support is configured with a set of models that are used to clarify and obtain

information for making efficient and effective decisions in complex environments. Thus, mathematical modeling, optimization tools and techniques and quantitative character tools provide the basis for the system to work in a smart way.

An input of information for decision-making is the identification and characterization of the demand for goods and services, for which there are a number of tools for the prediction, which forms the basis for planning transversely in all functions of the organization and supply chain.

The life cycle of products directly affects the demand for goods and services, and demand is affected by the policies of the State in regulating the conduct of the competition, market trends, and other factors such as price, quality, performance, and characteristics that differentiate the products and services. For all these reasons, there are many techniques and methods for forecasting and estimates based on knowledge of the demand, but it is necessary to determine which model, technique or procedure is appropriate.

The construction of models for analysis and development of productive capacities in organizations is extensive and varied and depends on the type of organization, the state in which it has, besides its own organizational structure, culture and dynamics in response to market trends and environment. But we can start with an archetype that can be adjusted according to circumstances.

## REFERENCES

- Abdul-Jalal, H., Toulson, P., & Tweed, D. (2013). Knowledge Sharing Success for Sustaining Organizational Competitive Advantage. *Procedia Economics and Finance*, 7(0), 150-157. doi: [http://dx.doi.org/10.1016/S2212-5671\(13\)00229-3](http://dx.doi.org/10.1016/S2212-5671(13)00229-3)
- Ahmad, A., Bosua, R., & Scheepers, R. (2014). Protecting organizational competitive advantage: A knowledge leakage perspective. *Computers & Security*, 42(0), 27-39. doi: <http://dx.doi.org/10.1016/j.cose.2014.01.001>
- Babnik, K., Širca, N. T., & Dermol, V. (2014). Individuals Learning in Work Teams: Support to Knowledge Management Initiatives and an Important Source of Organizational Learning. *Procedia - Social and Behavioral Sciences*, 124(0), 178-185. doi: <http://dx.doi.org/10.1016/j.sbspro.2014.02.475>
- Berends, H., Vanhaverbeke, W., & Kirschbaum, R. (2007). Knowledge management challenges in new business development: Case study observations. *Journal of Engineering and Technology Management*, 24(4), 314-328. doi: <http://dx.doi.org/10.1016/j.jengtecman.2007.09.006>
- Bermell-Garcia, P., Verhagen, W. J. C., Astwood, S., Krishnamurthy, K., Johnson, J. L., Ruiz, D. Curran, R. (2012). A framework for management of Knowledge-Based Engineering applications as software services: Enabling personalization and codification. *Advanced Engineering Informatics*, 26(2), 219-230. doi: <http://dx.doi.org/10.1016/j.aei.2012.01.006>
- F. Jacobs, W. L. (2011). *Manufacturing planning and control for supply chain management*. New York: McGraw-Hill.
- López Bello, C. A., D. K. (2005). Modelos de medición, análisis, planeación y programación de capacidades en un contexto de múltiples criterios. *Ingeniería*, 2(1), pp. 26-40.
- López Bello, C. A., L. J. (2006). Modelo de planeación de capacidades utilizando programación fraccional lineal en un contexto de múltiples criterios de decisión. *Ingeniería*, 11(2), pp. 48-60.
- López Bello, C. A., (2006). *Modelo integral de producción en empresas manufactureras*. Bogotá: Kimpres.
- López Bello, C. A., (2009). Modelo de ampliación de capacidades. *Revista Ingeniería*, 14(2), pp. 67-77.
- E E Ebert, R. J. (1991). *Production and Operations Management*. Prentice Hall.
- Elwood S. Buffa, R. K. (1987). *Modern Production/Operations Management, 8th Edition*. Wiley.
- Jacobs, W. L. (2011). *Manufacturing planning and control for supply chain management*. New York: McGraw-Hill.
- Robert Jacobs, R. B. (2010). *Operations and Supply Chain Management Global Edition*. McGraw-Hill Higher Education; Edition: 13.



- Jack R. Meredith, S. M. (2012). *Operations Management for MBAs*. 5th Edition Wiley.
- Johnny Rungtusanatham, S. G. (2012). *Operations Management in the Supply Chain: Decisions and Cases*. 6th edition. Tata McGraw-Hill India Pvt Ltd.
- Starr. (1979). *Administración de la producción. Sistemas y síntesis*. Madrid: Ed. Dossat S.A.
- Machuca, J. E. (1995). *Dirección de operaciones: Aspectos tácticos y operativos en la producción y los servicios*. Madrid: Editorial McGraw-Hill.
- Companys Pascual. (1989). *Planificación y programación de la producción*. Barcelona: Marcombo S.A.
- Riggs, J. L. (1987). *Production Systems: Planning, Analysis and Control*. Hardcover: Wiley series in production/operations management.
- Roberta S. Russell, B. W. (2011). *Operations Management: Creating Value Along the Supply Chain, 7th Edition*. Wiley.
- Roger Schroeder, M. J. (2012). *Operations Management in the Supply Chain: Decisions and Cases*. McGraw-Hill/Irwin Series, Operations and Decision Sciences.
- Nahmias, S. (2009). *Production and Operations Analysis*. Chicago: Ed. Irwin.
- Starr, M. (1979). *Administración de la producción. Sistemas y síntesis*. Madrid: Ed. Dossat S.A.
- Tawfik, L. (1992). *Administración de la producción*. México D.F.: Ed. McGraw-Hill.
- Zhen, L., Song, H.-T., & He, J.-T. (2012). Recommender systems for personal knowledge management in collaborative environments. *Expert Systems with Applications*, 39(16), 12536-12542. doi: <http://dx.doi.org/10.1016/j.eswa.2012.04.060>

## Synthesis and characterization of In(O;OH)S/AgInS<sub>2</sub> interface heterojunction

### Síntesis y caracterización de interfase de heterojuntura In(O;OH)S/AgInS<sub>2</sub>

William Vallejo\*, Carlos Díaz Uribe\*\*, Carlos Andrés Arredondo\*\*\*, Mario Alberto Luna\*\*\*\*, Johann Hernández\*\*\*\*\*, Gerardo Gordillo\*\*\*\*\*

**Fecha de recepción:** June 10th, 2014

**Fecha de aceptación:** November 4th, 2014

**Citation / Para citar este artículo:** Citation / Para citar este artículo: Vallejo, W., Uribe, C. D., Arredondo, C. A., Luna, M. A., Hernández, J., & Gordillo, G. (2014). Synthesis and characterization of In(O;OH)S/AgInS<sub>2</sub> interface heterojunction. *Revista Tecnura*, 18 (Edición especial doctorado), 30–40. doi: 10.14483/udistrital.jour.tecnura.2014.DSE1.a02

#### ABSTRACT

In this work, we presented some complementary studies for In(O,OH)S thin films deposited on AgInS<sub>2</sub> thin films to fabricate a new system absorbent-layer/buffer-layer to be used in tandem and/or in one-junction solar cells. As showed in previous works carried out for us, AgInS<sub>2</sub> layers were grown by co-evaporation from metal precursors in a two-step process; and In(O,OH)S thin films were deposited by Chemical Bath deposition. X-ray diffraction measurements

indicated that AgInS<sub>2</sub> thin film grown with chalcopyrite structure; and In(O,OH)S films grown with polycrystalline structure. The AgInS<sub>2</sub> thin films presented p-type conductivity, and from transductance measurements it was found a high absorption coefficient (greater than 10<sup>4</sup> cm<sup>-1</sup>) and an energy band gap of 1.95 eV; and In(O,OH)S thin films presented E<sub>g</sub> about 3.01 eV; morphological analysis indicated that under this synthesis conditions, In(O,OH)S thin films coated completely the AgInS<sub>2</sub> absorber

\* He received his PhD in Chemistry (solar energy materials and solar cells) in 2011 from Universidad Nacional de Colombia. He is an associate professor of Chemistry program at Universidad del Atlántico from 2012. His main research interest areas are synthesis and characterization of PV Materials. [williamvallejo@mail.uniatlantico.edu.co](mailto:williamvallejo@mail.uniatlantico.edu.co)

\*\* He received his PhD in Chemistry in 2010 from Universidad Industrial de Santander. He is an assistant professor of Chemistry program at Universidad del Atlántico from 2012; currently, he is director of research group in Photochemistry and Photobiology. [carlosdiaz@mail.uniatlantico.edu.co](mailto:carlosdiaz@mail.uniatlantico.edu.co)

\*\*\* Electrical Engineer, PhD in Physics (solar energy materials and solar cells) from Universidad Nacional de Colombia. Assistant professor of the energy engineering program at Universidad de Medellín from 2012, and researcher of the Grupo de Investigación en Energía – GRINEN of the same university. The main research interest areas are: PV systems and materials for solar cells, and renewable energy systems implementation on rural and urban areas. Medellín, Colombia. [caarredondo@udem.edu.co](mailto:caarredondo@udem.edu.co)

\*\*\*\* Environmental and Sanitary Engineer, PhD in Environmental Conservation (focused on renewable energy) in 2011 at the Estonian University of Life Sciences from Tartu, Estonia; in 2009 received the master degree in Environmental Sciences and Territory Management at Institute Supérieur d'Agriculture from Lille, Francia. Researcher/lecturer at Universidad de Medellín since 2012. The interested work area is focused on the implementation of renewable energy systems on urban and rural areas. Medellín, Colombia. [mluna@udem.edu.co](mailto:mluna@udem.edu.co)

\*\*\*\*\* Electrical Engineer. MSc and PhD degrees in Electrical Engineering from Universidad Nacional de Colombia in 2007 and 2012, respectively. In 2009 he joined the staff of the Department of Electrical Engineering at Universidad Distrital Francisco José de Caldas, where he works currently as Associate Professor and director member of Laboratory in Alternative Energy Sources (LIFAE). His research interests include power quality, photovoltaic systems, distributed generation, microgrids and energy efficiency. [jahernandezm@udistrital.edu.co](mailto:jahernandezm@udistrital.edu.co)

\*\*\*\*\* Bachelor in Physics. MSc in Physics from Universidad Nacional de Colombia in 1974. PhD degree in Electronic-Physics from Stuttgart University, Germany, in 1984. He is currently a professor with the Department of Physics at Universidad Nacional de Colombia. His research fields are thin film photovoltaics devices and photovoltaic generation systems. [ggordillo@unal.edu.co](mailto:ggordillo@unal.edu.co)

layer. Finally, the Avrami-Erofeev equation was used in this work to study In(O;OH)S thin film growth rate on AgInS<sub>2</sub> substrate. Results indicate that the developed system can be used in single-junction and multiple junction solar cells.

**Keywords:** absorber layer thin film, AgInS<sub>2</sub>, buffer layer, In(O;OH)S, optic window, solar cells.

## RESUMEN

En este trabajo presentamos estudios complementarios de películas delgadas de In(O;OH)S depositadas sobre películas delgadas de AgInS<sub>2</sub> para fabricar un sistema capa absorbente/capa buffer utilizado en celdas solares tipo tándem o celdas de junta simple. Como se demostró en trabajos anteriores realizados por los autores, las capas de AgInS<sub>2</sub> crecieron por coevaporación de los metales precursores en un proceso de dos etapas; y las películas delgadas de In(O;OH)S se depositaron por baño químico. Las medidas de rayos X indican que las películas

de AgInS<sub>2</sub> crecen con estructura tipo calcopirita y las de In(O;OH)S con estructura policristalina. Las películas de AgInS<sub>2</sub> presentan conductividad tipo P, y de las medidas de transductancia se encontró un coeficiente de absorción alto (mayor a 10<sup>4</sup> cm<sup>-1</sup>), y un gap de 1.95 eV; las películas de In(O;OH)S presentaron un gap de 3.01 eV; el análisis morfológico indica que bajo estas condiciones de síntesis, las películas de In(O;OH)S recubren completamente la capa absorbente de AgInS<sub>2</sub>. Finalmente, en este trabajo se aplicó la ecuación de Avrami-Erofeev para estudiar la tasa de crecimiento de las películas delgadas de In(O;OH)S sobre el substrato de AgInS<sub>2</sub>. Los resultados indican que el sistema desarrollado puede utilizarse en celdas solares de junta simple o multijuntura.

**Palabras clave:** ventana óptica, AgInS<sub>2</sub>; In(O;OH)S, capa buffer, capa absorbente, película delgada, celdas solares.

## INTRODUCTION

The highest conversion efficiencies reported for thin film solar cells has reached over 20.8% (Green *et al.*, 2014); this result was obtained for using CuInGaSe<sub>2</sub> (CIGS) as absorbent layer and Cadmium Sulphide (CdS) as buffer layer. Other semiconducting compounds such as CuGaSe<sub>2</sub>, CuInS<sub>2</sub> have been used as absorbent layers; however, they have reported lower energy conversion efficiencies (Green *et al.*, 2014, Wang *et al.*, 2012, Goetzberger *et al.*, 2003). It is well known in solar cell development technology that chalcopyrite type compounds from group I-III-VI<sub>2</sub> in periodic table have suitable properties to be used in single-junction and tandem solar cells because those compounds have shown direct gap. Nowadays, usage of Silver-Indium-Disulphide (AgInS<sub>2</sub>) as an alternative semiconductor material is expected to make a good solar cell absorber layer in multi-junction

systems due to its large absorption coefficient and its band-gap energy (E<sub>g</sub>) ranging from 1,87 to 2,03 eV (Albor *et al.*, 2007). Although, optimal E<sub>g</sub> is around 1,45 eV and AgInS<sub>2</sub> has higher E<sub>g</sub> values, its chalcopyrite structure and its lattice constant allows to form appropriate heterojunctions with semiconductors such as CdS and CuInSe<sub>2</sub>. The above mention argument justifies that AgInS<sub>2</sub> has possibly the required properties to be coupled successfully to grow CdS/AgInS<sub>2</sub>/CuGaSe<sub>2</sub> structures (Roth *et al.*, 1973; Loferski *et al.*, 1978).

CdS is typical buffer compound used in chalcopyrite solar cells; however, CdS compounds are considered hazardous materials to environment (Toxic Lethal Value: 50µg/m<sup>3</sup>) and, therefore, other less-toxic suitable compounds are being researched to substitute the CdS buffer layer based on two main arguments (Sankapal *et al.*, 2004; Lee *et al.*, 2012):

(1) The expected environmental risks arising from implementation of synthesis CdS thin film by CBD process in a CIGS module production line requires additional safety regulation (McEvoy *et al.*, 2013).

(2) The possibility to improve the light transmission in the blue wavelength region for using a material with a wider band gap than CdS (McEvoy *et al.*, 2013; Arredondo *et al.*, 2012).

Alternative buffer layers to CdS films have been assessed to fabricate Cd-free devices to improve photocurrent generation. Buffer layers composed by ZnS deposited by CBD and Atomic Layer Deposition (ALD) have shown high potential to be used as a buffer material (Naghavi *et al.*, 2006; Ennaoui *et al.*, 2005); system Zn(O,OH)S/ZnO reported efficiencies above 18% in CIGS based cells (Contreras *et al.*, 2003). Buffer layers in chalcopyrite based solar cells constituted by In<sub>2</sub>S<sub>3</sub>, In<sub>2</sub>Se<sub>3</sub>, ZnSe and (Zn, In) Se<sub>x</sub> have shown positive results as alternative buffer layer (Hariskos *et al.*, 2005). Moreover, properties such as stability, band gap energy (2,5-3,0 eV), photoconductor behavior and high transmittance (75-85%) in the visible range, make In(O,OH)S thin films an option to substitute CdS as buffer layer (Barreau *et al.*, 1995).

Different chemical and physical methods have been reported in the literature for AgInS<sub>2</sub> thin films deposition; however, best results have been obtained with AgInS<sub>2</sub> thin films obtained by physical methods (Yoshinory *et al.*, 1995; Ueno *et al.*, 1990; Sharma, 1995); for In(O,OH)S thin films, the CBD synthesis offers a low-cost option as it does not require high tech instrumentation, and chemicals are easily available, along this method uses low temperature deposition; it helps to avoid oxidation and corrosion substrates (Bhattacharya *et al.*, 2005).

This research articles focuses on the study of the characteristics of In(O,OH)S/AgInS<sub>2</sub> interface

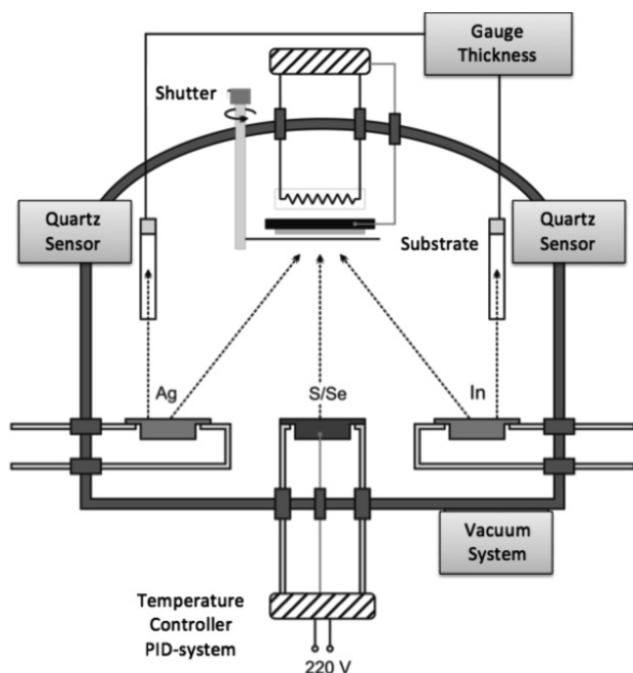
heterojunction to be implemented on solar cells (single-junction or tandem cells). AgInS<sub>2</sub> thin films were deposited by co-evaporation method in a two-step process; and In(O,OH)S thin films were deposited by CBD method.

## MATERIALS AND METHODS

### AgInS<sub>2</sub> thin film preparation

AgInS<sub>2</sub> thin films were prepared by co-evaporation from metallic precursor species on glass substrate on an evaporation chamber connected to a vacuum system with pressures around 10<sup>-5</sup> Torr, two tungsten crucibles (to evaporate Ag and In respectively), a tantalum effusion cell to evaporate sulfur, and a thickness monitor (Maxtec TM-400) with a quartz crystal to measure the evaporated elements flux. The substrate temperature was controlled with a programmable PID controller (Eurotherm 900C); figure 1 shows general scheme of physical deposition system. AgInS<sub>2</sub> thin films deposition was accomplished in two stages. An In<sub>x</sub>S<sub>y</sub> layer is grown in the first stage by means of simultaneous evaporation of In and S, keeping the substrate temperature at 300° C. The In flux and S evaporation temperature were kept at 2.5 Å/s and 135°C respectively during the whole stage.

Consecutively, on the second stage, AgInS<sub>2</sub> is formed by evaporating Ag (in a chamber filled with sulfur) over a layer of previously grown In<sub>x</sub>S<sub>y</sub> (first stage); substrate temperature and Ag flux were 400-600°C and approx. 3 Å/s respectively. AgInS<sub>2</sub> films were exposed to a post-deposition thermal annealing in S environment during approx. 1 hour, in order to improve its chemical composition.

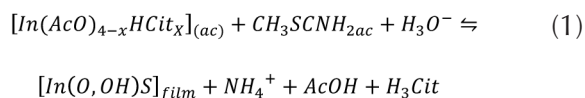


**Figure 1.** General scheme of physical deposition system using for AgInS<sub>2</sub> thin films deposition

**Source:** The authors.

### In(O,OH)S thin film preparation

In(O,OH)S layers were deposited using a solution prepared with thioacetamide (Scharlau) (TA) and indium chloride (InCl<sub>3</sub>) as sources of S<sup>2-</sup> and In<sup>3+</sup> ions respectively; InCl<sub>3</sub> was prepared in our laboratory using metallic In (99,9%) and HCl 36% (99,9% Merck). Acetic Acid (99,9% Merck) and Sodium Citrate (Riedel-de Haën) (Cit) were used as complexing agents of In<sup>3+</sup> ions. Two substrates were used to grow In(O,OH)S layers: soda lime glass coated with Indium Tin Oxide (ITO) and AgInS<sub>2</sub> deposited on soda lime glass; specific experimental conditions are described on Vallejo *et al.* (2010). The chemical reaction of the film preparation is presented in equation 1, as follows:



### Analytical methods

Optical, structural and morphological properties of AgInS<sub>2</sub> and In(O,OH)S thin films were studied through transmittance, XRD and AFM measurements carried out with a VIS-IR Oriel spectrophotometer, a Shimadzu 6000 diffractometer with Cu-K<sub>α</sub> radiation ( $\lambda = 0,15418$  nm) source over the diffraction angle  $2\theta$  between 20° and 80° and PSI AFM microscope with a scanned area (2  $\mu\text{m} \times 2$   $\mu\text{m}$ ). Film thickness was determined using a Veeco Dektak 150 surface profiler. AgInS<sub>2</sub> conductivity was determined by means of thermoelectric power measurements.

## RESULTS AND DISCUSSION

### In(O,OH)S thin film growth on AgInS<sub>2</sub> layers

CBD process kinetics for In(O,OH)S thin film growth on AgInS<sub>2</sub> layers and ITO substrates are presented on figure 2. Results obtained from the trials tend to follow a sigmoidal trend, typical from autocatalytic reactions (O'Brien *et al.*, 1998). Such behavior can be described by means of the Avrami-Erofeev equation (2).

$$\alpha = 1 - \exp(-kt^n) \quad (2)$$

Where  $\alpha$  is the fractional decomposition;  $t$  the time;  $k$  is a rate constant, and  $n$  the Avrami exponent which determines the nucleation and growth mode. The equation expresses the rate of formation of the nuclei, in the event when completely random nucleation occurs (Zhai *et al.*, 1007). During the growth process of In(O,OH)S thin film, 3 phases were identified: (1) induction time (start-up of the nucleation process), (2) an initial linear phase, and (3) final saturation phase (figure 2a). Induction time depends mainly on solution temperature, reagents concentration and substrate composition. During the second phase, film thickness increases exponentially with the time, while on the last phase growth



rate decreases as reagents concentration decay; normal behaviour of CBD process. Furthermore, it was observed that substrate composition can influence the growth rate of the In(O,OH)S. Kinetic rates are faster when AgInS<sub>2</sub> was used as substrate than ITO. CBD growth process is affected by the surface kinetic processes (Froment *et al.*, 1995). Determination of site availability for the formation of nuclei depends on composition and morphology of substrate, particularly the presence of defects as vacancies and interstitials (Ag, In, S) which can facilitate the presence of those sites (Arredondo *et al.*, 2010). If we considered that buffer thin film formation is based on the nucleus generation and succeeding growth (assuming constant temperature during the process), the Avrami-Erofeev equation (3) can be used to calculate the kinetic reaction parameters on different substrates (Zhai, 2007):

$$\ln[-\ln(1-\alpha)] = \ln k + n \ln(t) \quad (3)$$

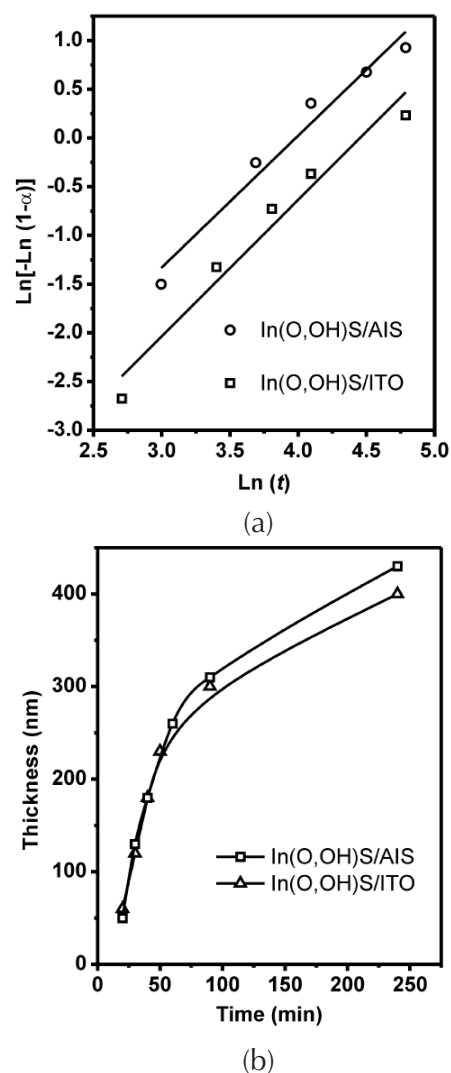
Plotting  $\ln[-\ln(1-\alpha)]$  vs  $\ln(t)$ , the reaction constant ( $k$ ) and the Avrami exponent ( $n$ ) can be obtained from the slope and the intercept of the lineal fitting respectively. Figure 2b indicates that substrate type affects growing rate of In(O,OH)S thin films;  $n$  value found indicates that both types of substrate consist of the same In(O,OH)S crystals nucleation mechanism because its values are approximately the same (table 1). However, unlike  $n$ ,  $k$  value changes significantly when substrate type varies; this value doubles when AgInS<sub>2</sub> absorbent layer is used, indicating that the growth process occurs at a greater rate on AgInS<sub>2</sub> than Soda Lime. This phenomenon can be attributed to different nucleation mechanism or the number of sites is different for the generation of nuclei. As a consequence of similar  $n$  values in both substrates, nucleation pathway has the same trend, and therefore, AgInS<sub>2</sub> presents a greater number of sites for nuclei generation than ITO substrate for In(O,OH)S crystals growing; results explained based on their composition and surface topography (in agreement with reports on Zn(O,OH)S and In(O,OH)S

thin films deposition on CuInS<sub>2</sub> layers) (Zhai *et al.*, 2007; Vallejo *et al.*, 2010).

**Table 1.** Growth kinetics parameters of In(O,OH)S thin films synthesized on different type substrates by CBD

Substrate	$k*1000$	$n$
AIS	7,5	1,36
ITO	3,0	1,41

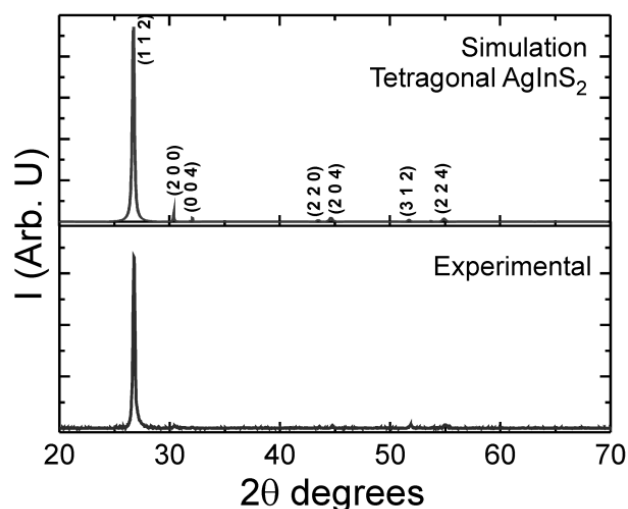
Source: The authors.



**Figure 2.** (a) In(O,OH)S growth rate variation on time synthesis and substrate type. (b)  $\ln[-\ln(1-\alpha)]$  vs  $\ln(t)$  curve with different substrates type

Source: The authors

### Structural characterization



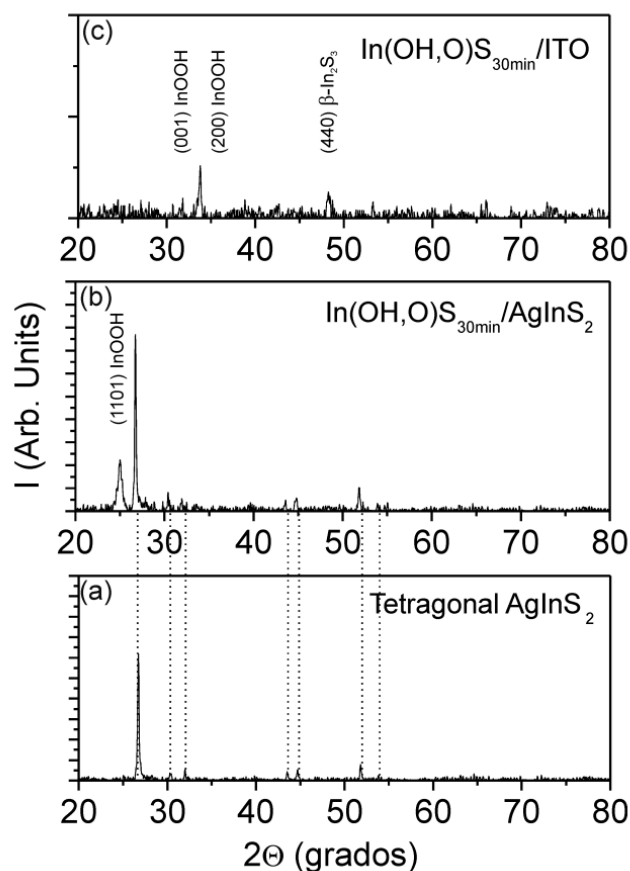
**Figure 3.** Comparison XRD pattern AgInS<sub>2</sub> thin films deposited by co-evaporation and one XRD pattern simulated assuming that sample grown in the tetragonal phase

**Source:** The authors.

#### AgInS<sub>2</sub> thin films

Figure 3 shows XRD spectra of AgInS<sub>2</sub> films deposited by co-evaporation; results were analyzed based on the data reported in the JCPDS database for these types of compounds, and performing theoretical simulation of the XRD pattern with PowderCell package. Rietveld method was used for simulation of tetragonal AgInS<sub>2</sub>-phase; geometry Bragg-Brentano with March-Dollase model was used to find the preferential orientation, and it was found to be (112). The function Pseudo-Voigt 1 was used; the number of iterations was 550 and the final  $\phi$  factor (shi factor) was 1,5. The described procedure was fundamental to identify the phases present in the samples with a high degree of confidence. It was found that AgInS<sub>2</sub> had grown with tetragonal structure. Seven peaks were observed: the highest was observed at  $2\theta=26,68^\circ$  corresponding to preferential plane growing (112); other peaks were identified as follows:  $2\theta=30,4^\circ$  to plane (200);  $2\theta=31,96^\circ$  to plane (004);  $2\theta=43,55^\circ$  to

plane (220);  $2\theta=46,62^\circ$  to plane (204);  $2\theta=51,80^\circ$  to plane (312) and  $2\theta=55,02^\circ$  to plane (224). These results are in agreement with JCPDS No. 251330. The lattice parameters determined from the X-ray diffraction spectra for AgInS<sub>2</sub> films grown with chalcopyrite type tetragonal structure are:  $a = 5,8980\text{\AA}$  and  $b = 11,1935\text{\AA}$ . These results indicate that AgInS<sub>2</sub> layer fulfils structural requirements to be used as absorbent layer in thin film solar cells.



**Figure 4.** (a) XRD pattern AgInS<sub>2</sub> thin films deposited by co-evaporation; and XRD pattern of In(O,OH)S thin films deposited by CBD on (b) AgInS<sub>2</sub> and (c) ITO substrates (ITO signal were deleted)

**Source:** The authors

#### In(O,OH),S thin films

Figure 4 shows XRD pattern corresponding to In(O,OH)S thin films deposited on ITO and AgInS<sub>2</sub> substrates. Due to its small thickness, crystallinity

of In(O,OH)S thin films were very poor; XRD patterns demonstrate that In(O,OH)S layers are polycrystalline. Samples deposited on ITO present just three reflections: the first two at  $2\theta=33,7^\circ$  and at  $2\theta=34,1^\circ$ , which corresponds to (001) and (200) planes of Indium Oxide Hydroxide (InOOH) (JCPDS # 17-0549), and the third reflection at  $2\theta=48,37^\circ$  associated to (2212) plane from tetragonal  $\beta$ -In<sub>2</sub>S<sub>3</sub> phase (JCPDS #25-0390).

On the other hand, samples deposited on AgInS<sub>2</sub> presented one reflection at  $2\theta=25,7^\circ$  which corresponds to (110) plane of Indium Oxide Hydroxide (InOOH) (JCPDS # 17-0549). Under reaction conditions, it is possible that during CBD process, a mixture of In<sub>2</sub>S<sub>3</sub>, In(OH)<sub>3</sub> and In<sub>2</sub>O<sub>3</sub> can be obtained (Larina *et al.*, 2003); however, results reported by other authors on In<sub>2</sub>S<sub>3</sub> thin films structure deposited by CBD, suggesting a mixture of the cubic a and b In<sub>2</sub>S<sub>3</sub> phases (Lokhande *et al.*, 1999; Bayon *et al.*, 2000). The presence of Indium oxide hydroxide and another phases of In<sub>2</sub>S<sub>3</sub> such as g and e have been also reported (Larina *et al.*, 2003, Bayon *et al.*, 2000). Results indicate that buffer layer films deposited on ITO and AgInS<sub>2</sub> exhibit polycrystalline structure and might contain a mixture of In<sub>2</sub>S<sub>3</sub> and In(O,OH) phases.

This phenomenon can be explained due to its hydrodynamic of reaction medium because in our case a co-precipitation of another species is possible; due to final composition of buffer layer synthesized by CBD (where different chemical phases are mixed), is common named this material as In(O,OH)S. Along with this, In(O,OH)S thin films deposited by CBD were polycrystalline on both ITO and AgInS<sub>2</sub> substrates. These results are important because they indicate that the recipe used allows to obtain polycrystalline thin film independently on the substrate used. To photovoltaic application, it is necessary to obtain a correct junction with electric contact on top cell (ZnO commonly used) for electrical transport and, In(O,OH)S thin films were polycrystalline on AgInS<sub>2</sub> substrates, this enhance the junction to electric contact.

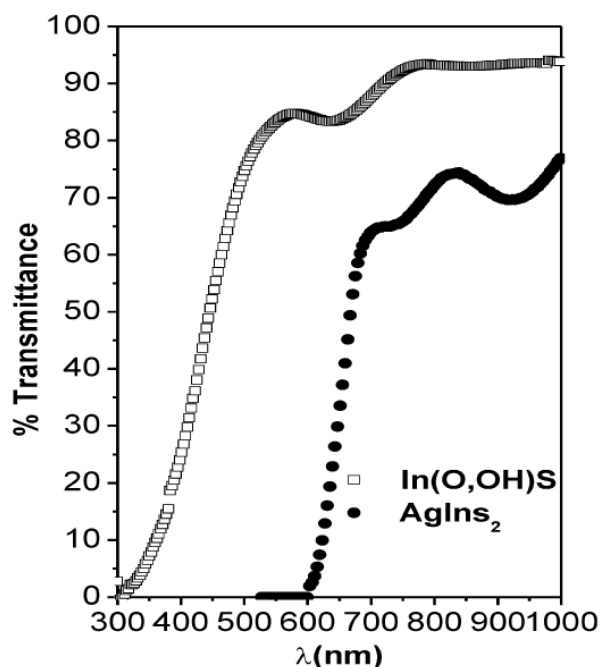
## Optical characterization

AgInS<sub>2</sub> and In(O,OH)S thin films were characterized through spectral transmittance measurements; optical properties of In(O,OH)S were determined from transmission measurements in the range of 300–1000 nm. Figure 5 shows typical transmission spectra of AgInS<sub>2</sub> and In(O,OH)S films. In(O,OH)S films deposited on AgInS<sub>2</sub> substrate were homogeneous with adequate substrate adherence. In(O,OH)S thin film showed optical transmission of 80-90% in the visible range. High transparency in the visible region indicates absence of adsorbed powdery colloids formed by homogeneous reaction during the film growth. A sharp absorption edge is observed in the visible region, indicating relatively good crystallinity and low defect density near the band edge (Gracia *et al.*, 2005). For AgInS<sub>2</sub> thin films, it is observed that transmittance spectra have a sharp absorption edge in the visible region.

Based on the optical transmission measurements, the square of absorption coefficient ( $\alpha^2$ ) is plotted as a function of photon energy (hν). Figure 6 shows results of n vs. l, a vs. l and  $(\alpha hn)^2$  vs. hn for AgInS<sub>2</sub> substrates and buffer layers. Those results were determined based on (Gracia *et al.*, 2005). Figure 6 shows that AgInS<sub>2</sub> films have an absorption coefficient a greater than 10<sup>4</sup> cm<sup>-1</sup> and an optical gap E<sub>g</sub> of 1,93 eV. These results indicate that AgInS<sub>2</sub> thin films have suitable properties for using them as absorber layers in two junction tandem solar cells. In(O,OH)S band gap (3,01eV) was greater than In<sub>2</sub>S<sub>3</sub> bulk band gap (2,4-2,7eV) (Asenjo *et al.*, 2007; Sandoval-Paz *et al.*, 2005); this shift may be due to the CBD technique. The E<sub>g</sub> of In(O,OH)S depends on the film's stoichiometry, and it can be found between 2,0 eV and 3,7 eV for In<sub>2</sub>S<sub>3</sub> and In<sub>2</sub>O<sub>3</sub> respectively (Bayon *et al.*, 1998). This result is in agreement with the E<sub>g</sub> reported for In(O,OH)S thin films obtained by CBD (Larina *et al.*, 2003; Huang *et al.*, 2001; Yousfi *et al.*, 2000).

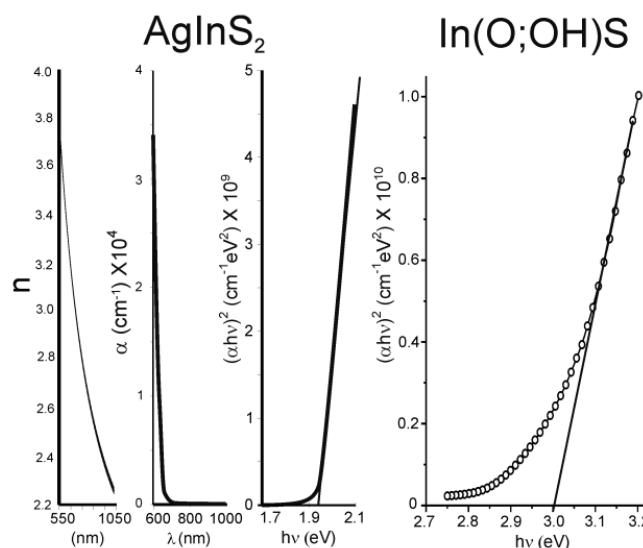
In CBD process the co-precipitation of another species is common; in our case, In(OH)<sub>3</sub> and In<sub>2</sub>O<sub>3</sub> can be presented in a buffer layer; these

compounds could shift the band gap to blue energies; this phenomenon is very favorable because blue response in solar cells enhance system performance. Furthermore, figures 5 and 6 showed that In(O,OH)S thin films presented better optical properties than CdS thin films; this properties allow to use In(O,OH)S thin films as buffer layer on solar cells. Along, differences in band gaps materials are favorable to heterojunction; high band gap values for In(O,OH)S (3,01eV) guarantee that sun radiation on visible range will not be absorbed on the buffer layer but it will be absorbed on AgInS<sub>2</sub> (greater than 10<sup>4</sup> cm<sup>-1</sup>); this system present typical characteristics to be used in single-junction solar cells and as top cell in a tandem solar cell system.



**Figure 5.** Optical transmission spectra of as-grown AgInS<sub>2</sub> thin films (1 μm thickness), and as-grown In(O,OH)S (100nm thickness)

**Source:** The authors



**Figure 6.** Plot of  $(\alpha hv)^2$  vs  $hv$  for: (a) as-grown AgInS<sub>2</sub> and (b) as-grown In(O,OH)S

**Source:** The authors

**Table 2.** Grain size average and roughness values derived from images displayed in figure 6

Sample	Grain size (nm)	Roughness $R_{ms}$ (nm)
AgInS <sub>2</sub> / In(O,OH)S <sub>15min</sub>	50	2,1
AgInS <sub>2</sub> / In(O,OH)S <sub>30min</sub>	80	2,8

**Source:** The authors

### Morphological characterization

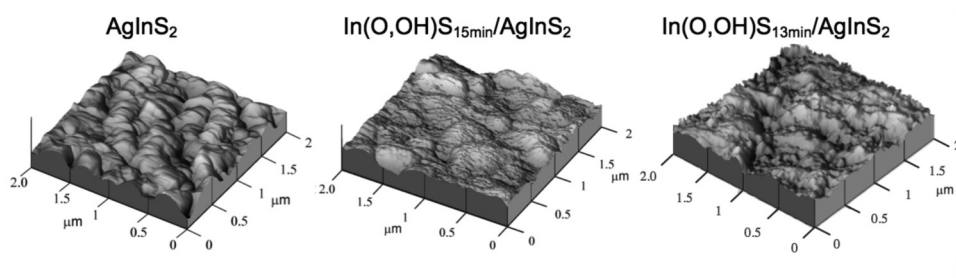
Figure 7 shows AFM images of In(O,OH)S thin films deposited by CBD over AgInS<sub>2</sub> layer. The AgInS<sub>2</sub>-substrate AFM image shows columnar crystals, typical for AgInS<sub>2</sub> (1 μm thickness) with tetragonal structure; it also shows the effect of In(O,OH)S morphology on thin film thickness; it is clearly seen from AFM images that grain size of In(O,OH)S particles are smaller than grain size of AgInS<sub>2</sub> particles (240 nm).

After 15 minutes buffer deposition has started, grain particles of different sizes are distributed randomly throughout the substrate without any crack (figure 7); along, In(O,OH)S thin films grain size



and  $R_{ms}$  roughness increases significantly when the film thickness increases (table 2). At the initial stage of deposition, many nucleation centers are present on the substrate, and small crystallites are produced; for short time deposition intervals, films with small crystallites are not able to grow into

bigger ones, whereas for thicker films the crystallinity of the film crystallites grew bigger. It can also be seen in figure 7 that after 30 minutes of CBD process is possible to cover completely and uniformly the AgInS<sub>2</sub> surface. It is a very important requirement for thin films as buffer layer.



**Figure 7.** Atomic force micrographs of In(O,OH)S thin films deposited on AgInS<sub>2</sub> with different deposition times.

**Source:** The authors.

## CONCLUSIONS

By using a system composed of In(O,OH)S/AgInS<sub>2</sub> (buffer/absorbent), it was found that In(O,OH)S buffer layers growth on AgInS<sub>2</sub> substrates were uniform, adherent and specular. It also presented good macroscopic properties. Furthermore, kinetic studies on deposition of In(O,OH)S over AgInS<sub>2</sub> indicated a growth rate variation on the substrate type used. Nucleation process model indicates a significant faster process on AgInS<sub>2</sub> than ITO substrates, explained by the differences in composition and topography of the surface substrates. XRD analysis showed that buffer layer films deposited on ITO and CGS exhibited polycrystalline structure with a possible mixture of In<sub>2</sub>S<sub>3</sub> and In(OOH) phases; additionally, it was found that AgInS<sub>2</sub> has grown with tetragonal structure at plane (112) as preferential plane. Optical, structural and morphological characterization of the system indicate that In(O,OH)S/AgInS<sub>2</sub> layers obtained can be used in single-junction and multiple-junction solar cells.

## ACKNOWLEDGEMENTS

This research was supported by Universidad de Medellín, Universidad Nacional de Colombia, Universidad del Atlántico and Universidad Distrital Francisco José de Caldas.

## REFERENCES

- Albor, M., Aguilar, J., González, M., & Ortega, C. G. (2007). Photoluminescence studies of chalcopyrite and orthorhombic AgInS<sub>2</sub> thin films deposited by spray pyrolysis technique, *Thin Solid Films*, 515(31), 6272–6275.
- Arredondo, C., & Gordillo, G. (2010). Photoconductive and electrical transport properties of AgInSe<sub>2</sub> thin films prepared by co-evaporation. *Physica B: Condensed Matter*, 405, 3694-3699.
- Arredondo, C., Vallejo, W., Hernández, J., & Gordillo, G. (2012). In(O,OH)S/AgInS<sub>2</sub> absorbent layer/buffer layer system for thin film solar cells. *38th IEEE Photovoltaic Specialists Conference (PVSC)*, 001988-001991.
- Asenjo, B. et al. (2007). Study of CuInS<sub>2</sub>/buffer/ZnO solar cells, with chemically deposited Zn<sub>3</sub>-In<sub>2</sub>S<sub>3</sub> buffer layers. *Thin Solid Films*, 515(15). 6036-6040.
- Barreau, N., Marsillac, S., Albertini, D., & Bernede, J. (2002). Structural, optical and electrical properties



- of  $\beta$ -In<sub>2</sub>S<sub>3-3x</sub>O<sub>3x</sub> thin films obtained by PVD. *Thin Solid Films*. 403, 331-334.
- Bayon, R. et al. (1989). Preparation of Indium Hydroxy Sulfide In<sub>x</sub>(OH)<sub>y</sub>S<sub>z</sub> Thin Films by Chemical Bath Deposition. *Journal of the Electrochemical Society*. 145(8), 2775-2779.
- Bayon, R., & Herrero, J. (2000). Structure and morphology of the indium hydroxy sulphide thin films. *Applied Surface Science*. 58(1-2), 49-57.
- Bhattacharya, R., Ramanathan, K., Gedvilas, L., & Keyes, B. (2005). Cu(In,Ga)Se<sub>2</sub> thin-film solar cells with ZnS(O,OH), Zn-Cd-S(O,OH), and CdS buffer layers. *Journal of Physics and Chemistry of Solids*. 66(11), 1862-1864.
- Contreras, M. et al. (2003). ZnO/ZnS(O,OH)/Cu(In,Ga)Se<sub>2</sub>/Mo solar cell with 18.6% efficiency. *3<sup>rd</sup> World Conference on Photovoltaics Energy Conversion*, Osaka, Japan.
- Ennaoui, A. et al. (2005). New Chemical Route for the Deposition of ZnS Buffer Layers: Cd-freeCuInS<sub>2</sub>-based thin film solar cells with efficiencies above 11%. *20<sup>th</sup> European Photovoltaic Solar Energy Conference*.
- Froment, M., & Lincot, D. (1995). Phase formation processes in solution at the atomic level: Metal chalcogenide semiconductors. *Electrochimica Acta*. 40(10), 1293-1303.
- Goetzberger, A., Hebling, C., & Schock, H.-W. (2003). Photovoltaic materials, history, status and outlook. *Materials Science and Engineering: R: Reports*. 40(1), 1-46.
- Gracia, M., Rojas, F., & Gordillo, G. (2005). Morphological and optical characterization of SnO<sub>2</sub>: F thin films deposited by spray pyrolysis. *20<sup>th</sup> European PV Solar Energy Conference*, 1874-1877.
- Green, M. et al. (2014). Solar cell efficiency tables (version 43). *Progress in Photovoltaics: Research and Applications*. 22(1), 1-9.
- Hariskos, D., Spiering, S., & Powalla, M. (2005). Buffer layers in Cu(In,Ga)Se<sub>2</sub> solar cells and modules. *Thin Solid films*. 480, 99-109.
- Huang, C. et al. (2001). Study of Cd-free buffer layers using In<sub>x</sub>(OH)<sub>y</sub>S<sub>z</sub> on CIGS solar cells. *Solar Energy Materials & Solar Cells*. 69(2), 131-137.
- Larina, L. et al. (2003). Thin film CIGS-based solar cells with an In-based buffer layer fabricated by chemical bath deposition. *3<sup>rd</sup> World Conference on Photovoltaic Energy and Conversion*. 1, 531- 534
- Lee, C. et al. (2012). Design of energy band alignment at the Zn<sub>1-x</sub>Mg<sub>x</sub>O/Cu(In,Ga)Se<sub>2</sub> interface for Cd-free Cu(In,Ga)Se<sub>2</sub> solar cells. *Physical Chemistry Chemical Physics*. 14, 4789-4795.
- Loferski, J. et al. (s. d.). RF-sputtered CuInSe<sub>2</sub> thin films. *13<sup>th</sup> IEEE photovoltaic specialists Conference*, 190.
- Lokhande, C. et al. (1999). Chemical bath deposition of indium sulphide thin films: preparation and characterization. *Thin Solid Films*, 340(1-2), 18-23.
- McEvoy, A., Markvart, T., & Castañer, L. (2013). *Solar Cells: Materials, Manufacture and Operation*. Second Edition. The Netherlands. Elsevier, 2, 35-45.
- Naghavi, N. et al. (2006). From CdS to Zn(S,O,OH): A better understanding of chemical bath deposition parameters and cells properties using electrodeposited CuIn(S,Se)<sub>2</sub> and coevaporated Cu(In,Ga)Se<sub>2</sub> absorbers. *21<sup>st</sup> European Photovoltaic Solar Energy Conference*, Dresden, 1843.
- O'Brien, P., & McAleese, J. (1998). Developing an understanding of the processes controlling the chemical bath deposition of ZnS and CdS. *Journal of Materials Chemistry*, 8(11), 2309-2314.
- Roth, R., Parker, H., & Brower, S. (1973). Synthesis of mercury bismuth sulfide HgBi<sub>2</sub>S<sub>4</sub>. *Materials Research Bulletin*, 8(7), 859-862
- Sandoval Paz, M. et al. (2005). Structural and optical studies on thermal-annealed In<sub>2</sub>S<sub>3</sub> films prepared by the chemical bath deposition technique, *Thin Solid Films*, 472(1-2), 5-10.
- Sankapal, B., Sartale, S., Lokhande, C., & Ennaoui, A. (2004). Chemical synthesis of Cd-free wide band gap materials for solar cells, *Solar Energy Materials & Solar Cells*. 83(4), 447-458.
- Sharma, R. P. (1995). Influence of annealing in vacuum on opto-electronic characteristics of solution grown AgInSe<sub>2</sub> films. *Indian Journal of Pure & Applied Physics*, 33, 711.
- Ueno, Y., Kojima, Y., Sugiura, T., & Minoura, H. (1990). Electrodeposition of AgInSe<sub>2</sub> films from a sulphate bath. *Thin Solid Films*. 189(1), 91-101.

- Vallejo, W., Clavijo., & J. Gordillo, G. (2010). CGS Based Solar Cells with In<sub>2</sub>S<sub>3</sub> Buffer Layer Deposited by CBD and Coevaporation. *Brazilian Journal of Physics*, 40(1), 30-37.
- Vallejo, W., Hurtado, M., & Gordillo, G. (2010). Kinetic study on Zn(O,OH)S thin films deposited by chemical bath deposition. *Electrochimica Acta*, 55(20), 5610-5616.
- Wang, W. et al. (2012). Synthesis of CuInSe<sub>2</sub> monodisperse nanoparticles and the nanorings shape evolution via a green solution reaction route. *Materials Science in Semiconductor Processing*. 15(5), 467-471.
- Yoshinory, E., & Hamakawa. N. (1995). Formation and Properties of AgInSe<sub>2</sub> Thin Films deposited from Alloy Chunks. *Japanese Journal of Applied Physics*. 34(1) 3260-3265.
- Yousfi, E. et al. (2000). Cadmium-free buffer layers deposited by atomic layer epitaxy for copper indium diselenide solar cells, *Thin Solid Films*, 361, 183-186.
- Zhai, R. et al. (2007). Kinetic studies on CaWO<sub>4</sub> thin films by chemical bath deposition. *Journal of Physics D: Applied Physics*. 40, 4039.

## Transient surges analysis in low voltage networks

### Análisis de transitorios de sobretensión en redes de baja tensión

Andrés Alfonso Rodríguez\*, Luis Eduardo Perdomo Orjuela\*\*,  
Francisco Santamaría Piedrahíta\*\*\*, Carlos Antonio Gómez Vargas\*\*\*\*

**Fecha de recepción:** June 10th, 2014

**Fecha de aceptación:** November 4th, 2014

**Citation / Para citar este artículo:** Rodríguez, A. A., Perdomo Orjuela, L. E., Santamaría Piedrahíta, F., & Gómez Vargas, C. A. (2014). Transient surges analysis in low voltage networks. *Revista Tecnura*, 18 (Edición especial doctorado), 41–50. doi: 10.14483/udistrital.jour.tecnura.2014.DSE1.a03

#### ABSTRACT

Sensitivity analysis of a power system against over-voltage was performed. The analysis took into account the origin of the overvoltage, the grounding resistance magnitude and overvoltage injection point. The IEEE 13 bus test feeder system was implemented in EMTP-ATP and lightning and switching overvoltages were applied. Three cases were evaluated: the first one, applying lightning overvoltage and varying the grounding resistance magnitude; the second, applying lightning overvoltage in different points of the system with a fixed grounding resistance magnitude; and finally, applying switching overvoltage and varying the grounding resistance magnitude.

**Keywords:** EMTP-ATP, Ground Resistance, Power Quality, Transformer Model, Transient Overvoltage.

#### RESUMEN

Se realizó un análisis de sensibilidad en un sistema de potencia frente a sobretensiones. El análisis tuvo en cuenta el origen de la sobretensión, la magnitud de resistencia de puesta a tierra y el punto de inyección de sobretensión. El sistema IEEE 13 nodos se implementó en EMTP ATP y se introdujeron sobretensiones tipo rayo y maniobra. Se evaluaron tres casos, el primero, aplicando una sobretensión tipo rayo y variando la magnitud de resistencia de puesta a tierra; el segundo, aplicando sobretensiones tipo rayo en diferentes puntos del sistema con una magnitud de resistencia de puesta tierra fija y, por último, aplicando sobretensiones tipo maniobra variando la magnitud de resistencia de puesta a tierra.

**Palabras clave:** EMTP-ATP, resistencia de tierra, calidad de potencia, modelo del transformador, sobretensiones transitorias.

\* Electrical Engineer, Electromagnetic Compatibility and Interference Research Group, Universidad Distrital Francisco José de Caldas. Bogotá, Colombia. [aalfonsor@correo.udistrital.edu.co](mailto:aalfonsor@correo.udistrital.edu.co)

\*\* Electrical Engineer, Electromagnetic Compatibility and Interference Research Group, Universidad Distrital Francisco José de Caldas. Bogotá, Colombia. [leperdomoo@correo.udistrital.edu.co](mailto:leperdomoo@correo.udistrital.edu.co)

\*\*\* Electrical Engineer, MSc., PhD., Associated Professor at the Faculty of Engineering - Universidad Distrital Francisco José de Caldas, Bogotá, Colombia. [fsantamariap@udistrital.edu.co](mailto:fsantamariap@udistrital.edu.co)

\*\*\*\* Electrical Engineer, MSc (c). Professor at the Faculty of Engineering - Universidad Central, Bogotá, Colombia. [cgomezv1@ucentral.edu.co](mailto:cgomezv1@ucentral.edu.co)

## INTRODUCTION

Low voltage feeders may be affected by surges, giving rise to phenomena such as short interruptions and voltage sags (Cooray, 2003). These surges are generated by direct lightning strikes in low voltage feeders, induction by indirect discharges (intra-cloud, cloud-to-cloud, cloud-to-air or cloud-to-ground) (Pham, Pham & Tran, 2010), and surges of slow, fast and very fast front, transferred from medium voltage networks to low voltage networks (Piantini, 2010; Varju & Ladanty, 2007; Borghetti et al., 2006; Watson & Arrillaga, 2007).

The probability of direct lightning strikes in low voltage networks is very low due to the shielding action of medium voltage networks, trees and nearby structures. However, the length of rural and semi-urban low voltage feeders may exceed 1000 m, increasing the lightning strike probability (Piantini, 2010). Surges in low voltage networks transferred from medium voltage feeders through distribution transformers are mainly caused by direct and indirect lightning strikes (Piantini, 2010; Bachega & Martínez, 2004). Therefore, in the system modeling it is necessary to consider the transformer behavior to these transient signals; however, the transformer steady state model is not useful for a lightning overvoltage frequency range (Das, 2010), (Papadias, Hatzigryriou, & Prousalidis, 1993). In this sense, implemented models of surge transfer from medium voltage feeders to low voltage feeders include a capacitive network of the transformer (Scott & Liu, 1992; Costa & López, 2007; Justo de Araújo, Cleber da Silva & Kurokawa, 2013).

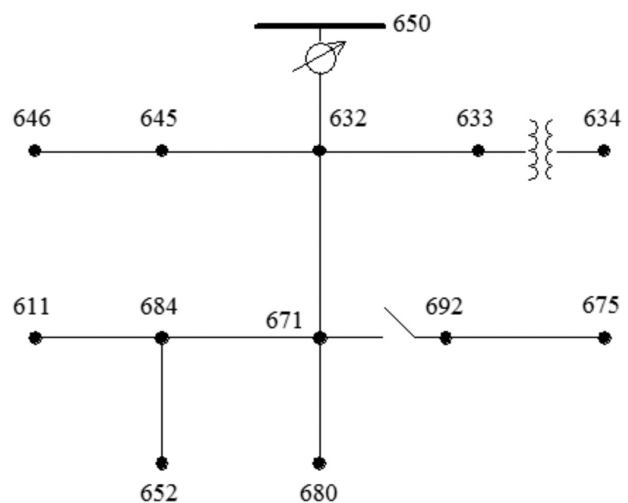
This work is part of the first phase of the project called "prototype for recording transient surges in less than 1 kV feeders". The project main goals are: development of a surge recorder prototype applying electromagnetic compatibility standards, remote information transmission from prototype to desktop software, and development of a mobile application for downloading the

recorded information on site and display the database information.

This paper shows typical surge parameters of low voltage systems, as peak voltage and rise time, in order to identify the behavior of surges in systems lower than 1 kV. This information is also used for designing the prototype signal conditioning stage. Simulations for IEEE 13 node test feeder (IEEE PES Distribution System Analysis Subcommittee's Distribution Test Feeder Working Group, 2000-2010), were done using the Alternative Transient Program (ATP) (Scott & Liu, 1992) for two conditions. In the first case, normalized waveform voltages 1,2/50 ms were applied in many system points. In the second case, surges caused by disconnection of an industrial load were evaluated. Furthermore, the grounding system effect on surge value was evaluated in all cases.

## SYSTEM DESCRIPTION

IEEE 13 node system (IEEE PES Distribution System Analysis Subcommittee's Distribution Test Feeder Working Group, 2000-2010) was used as reference for characterizing low voltage feeder surges. The topology of the test system is shown in Figure 1.

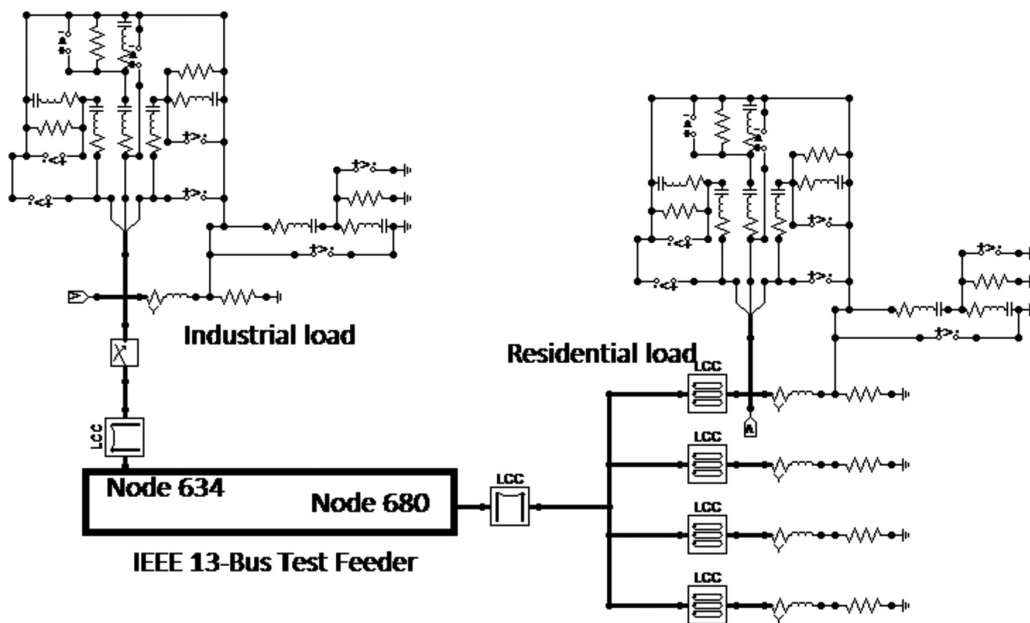


**Figure 1.** IEEE 13 node feeder

Source: IEEE PES (2010).

The ATP implemented system is shown in figure 2. Nodes 650 and 633 were used for simulating the lightning impact, and the distributed loads were located in nodes 632 and 671. Additionally, a Heidler source of 4 kV peak voltage was implemented to represent a standard lightning surge 1,2/50  $\mu$ s. (Martínez, 2008; Morched, Matí & Ottevangers, 1993; Costa & López, 2007). Opening of

one phase of an industrial load has a highly inductive characteristic and causes system high power consumption. Therefore, the opening was used for slow front surge characterization. The system was implemented in order to evaluate the sensitivity to direct impact and switching surges. IEEE 13 node feeder was modified to analyze overvoltages in low voltage for ground resistance variation.



**Figure 2.** IEEE 13 node feeder and charges implemented in ATP

Source: Own work.

### Industrial load

An inductive load of high power consumption (0,25 MVA and power factor of 0,85) was included in the distribution system. This load is connected to node 634 through a distribution line whose characteristics are given in Table 1.

**Table 1.** Distribution line characteristics

Node	Length (m)	Resistance (m $\Omega$ )	Reactance (m $\Omega$ )	Frequency (Hz)
633	324	119,9	144,5	60

Source: Own work.

### Residential load

Four residential loads, each one of 7 kVA and power factor 0,85 lagging were added. Connection of IEEE 13 node system to residential loads was performed through a distribution transformer located on node 680. Distribution overhead and underground cables were implemented to represent the supply connection of loads (Martínez, 2010), (CIGRE Working group 33.02, 1990). Table 2 and Table 3 show the transformer and cables characteristics.



**Table 2.** Distribution transformer characteristics

Node	Power (MVA)	Primary Voltage (kV)	Secondary Voltage (V)	Windings connection
680	0,5	4,16	208	Yn – Yn

Source: Own work.

**Table 3.** Underground cables characteristics

Node	Length (m)	Resistance (mW)	Reactance (mW)	Frequency (Hz)
680	100	9,68	107,2	60

Source: Own work.

### Transformer model

Right modeling of low voltage feeder components influences the analysis of surges (Bachega & Martínez, 2004). The transformer deserves particular attention because it transfers surges present in medium voltage networks to low voltage feeders (Antunes Tavares & Melo e Silva, 2014), (Martínez, 2010). Searching a suitable high frequency model transformer is considered a complex task because of the physical phenomena occurring in this device. Physical Phenomena such as (CIGRE Working group 33.02, 1990), (IEEE standars association, 2011):

- When the transformer is turned on, winding capacitances charging process starts and current flow begins in the dielectric structure.
- Losses in the transformer core are negligible because it has a linear behavior. Magnetic flux penetration into the core is not presented until 1  $\mu$ s elapsed.
- After 1  $\mu$ s, the flux begins to penetrate into the core, the main current path are the capacitances.
- From 1  $\mu$ s to 10  $\mu$ s, the transformer core saturates.
- Completed 10  $\mu$ s, the inductance coil has a non-linear behavior and magnetic flux will be fully penetrated into the core. In this stage, capacitive couplings remain its importance.

- After 10  $\mu$ s, the behavior of transformer is considered stable. Losses come from cables, core, dielectric and housing. Skin effect is considered in this section.

Transformer parameters importance depends on the analyzed process. Table 4 shows the transformer parameters influence in a power system transient analysis. The classification proposed in Martínez (2008) is: I unimportant, II important, and III very important.

**Table 4.** Transformer parameters importance based on fast transient

Parameter/ Effect	Low Frequency	Slow front	Fast front	Very fast front
Short circuit impedance	III	III	II	I
Saturation	III	II	I	I
Iron losses	II	I	I	I
Eddy currents	III	II	I	I
Capacitive coupling	I	II	III	III

Source: (Martínez, 2008).

CIGRE Working Group 33-02 has elaborated a document (CIGRE Working group 33.02, 1990) for specifying the power system elements representation according to the frequency ranges in which the system behavior will be evaluated. Table 5 shows this information.

**Table 5.** System representation according to working frequency

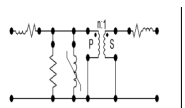
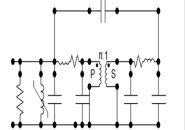
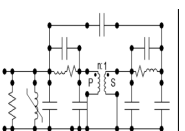
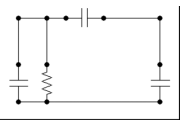
Group	Frequency Range	Designation	Representation
I	0,1 Hz – 3 kHz	Low frequency oscillations	Permanent surges
II	50 Hz – 20 kHz	Slow wave front	Switching surges
III	10 kHz – 3 MHz	Fast wave front	Lightning surges

IV	100 kHz – 50 MHz	Very fast wave front	Switching surges in Gas Insulated Substations
----	------------------	----------------------	---

Source: (CIGRE Working Group 33.02, 1990).

Table 5 shows the transformer modeling information respect to frequency range (Martínez, 2008).

**Table 6.** Transformer model according to working frequency

Model	Description
	Group I: 0,1 Hz – 3 kHz Takes into account saturation effects and iron and copper losses. Single-phase and three-phase cores can be identified.
	Group II: 50 Hz – 20 kHz Takes into account saturation effects and iron and copper losses. Single-phase and three-phase cores can be identified.
	Group III: 10 kHz – 3 MHz Capacitive coupling between windings. Short circuit impedance must be included.
	Group IV: 100 kHz – 50 MHz Capacitive coupling between windings. It is necessary to know the windings impedances.

Source: (Martínez, 2008).

### Grounding resistance

Grounding impedance has been included in order to evaluate its impact on surge in the low voltage system; it allows also to record surges in the neutral line. For simulation, a resistive model of grounding impedance was implemented, following electromagnetic compatibility design criteria, which allow neglect inductive coupling. High and medium voltage grounding resistance values are 1 and 10 Ω respectively (Ministerio de Minas y Energía, República de Colombia, 2008). Low voltage resistances are in the range of 1 to 100 Ω.

### METHODOLOGY

This section describes the scenarios proposed to evaluate the system sensitivity against surges caused by direct lightning strike impacts and system switching. Direct lightning strike has a 1,2/50 μs standard waveform with an amplitude of 4 kV, and 90% of occurrence probability (Borghetti, Napolitano, Nucci, Paolone, & Morched, 2006).

Case 1: direct lightning strike and low voltage grounding resistance variation: A lightning surge wave was injected in phase A of node 650. Grounding resistance was varied between 1 and 100 Ω, with 10 Ω steps. For residential and industrial loads, surges were measured in phases and neutral of the system.

Case 2: fixed low voltage grounding resistance and variable lightning strike point: A 25 Ω ground resistance was fixed (Ministerio de Minas y Energía, República de Colombia, 2008). A lightning surge wave was injected in phase A of nodes 650, 633 and in the distributed line in nodes 632 and

671. Surges were measured in phases and neutral of the system for residential and industrial loads.

Case 3: Switching phase A of industrial load. Low voltage grounding resistance kept constant and simultaneous measurement at different points of the system: The magnitude of low voltage ground resistance is  $25 \Omega$ . Phase A of industrial load was opened, which caused a switching surge. Surges were measured in phases and neutral of the system for residential and industrial loads.

## RESULTS

Results of ATP simulations for the described study cases are presented below. The results are in p.u., line voltages base values are 480 V and 208 V for industrial and residential loads, respectively.

### Case 1: direct lightning strike and low voltage grounding resistance variation

Figure 3 and figure 4 show the magnitude of the surge registered respectively in residential and industrial load, in all phases and neutral. Phase voltage is measured with respect to neutral and neutral with respect to ground. Phase A results in Figure 3 suggest the need of a protection device for connected electronics and electric machines to avoid the progressive damage of components (Chowdhuri, 1996; Indulkar, Thomas & Bijwe, 1992). Figure 4 shows that for a grounding resistance larger than  $15 \Omega$ , an electronic device or an electric machine would be subject to voltages higher than 4 kV. These levels cause electromagnetic susceptibility problems (IEEE Std 1159 Recommended practice for monitoring electric and power quality, 2009), (IEEE Std 446 Recommended practice for emergency and standby power systems for industrial and commercial applications, 1995), (Herrera, Perez, & Torres, 2003), (Escamilla, Gomez, & Tejada, 2009), (Gómez, 2013).

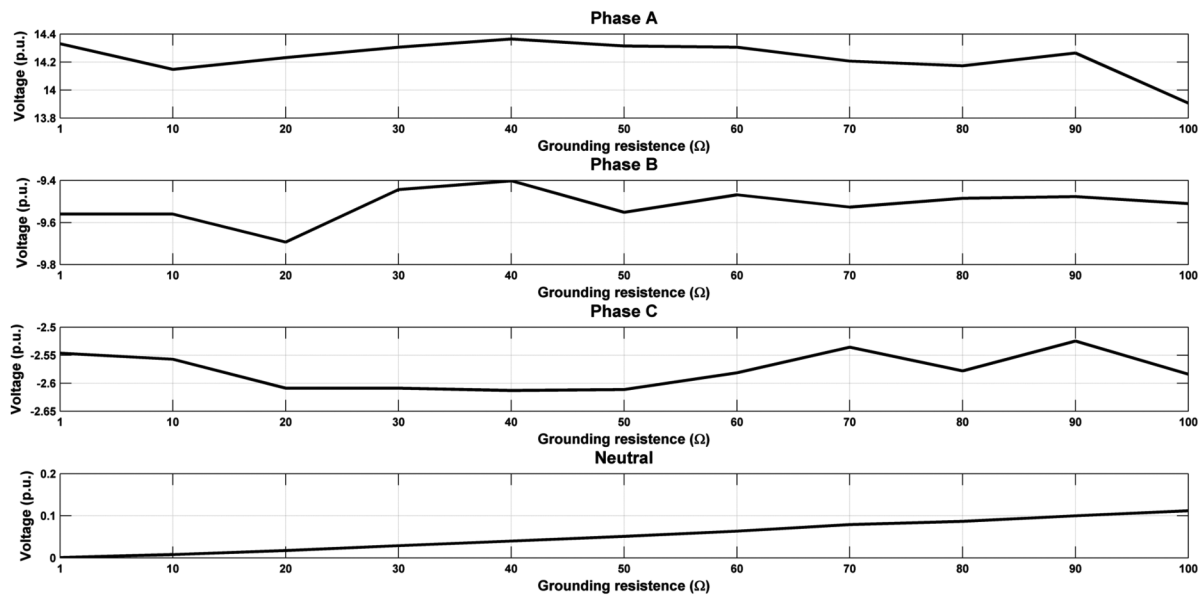
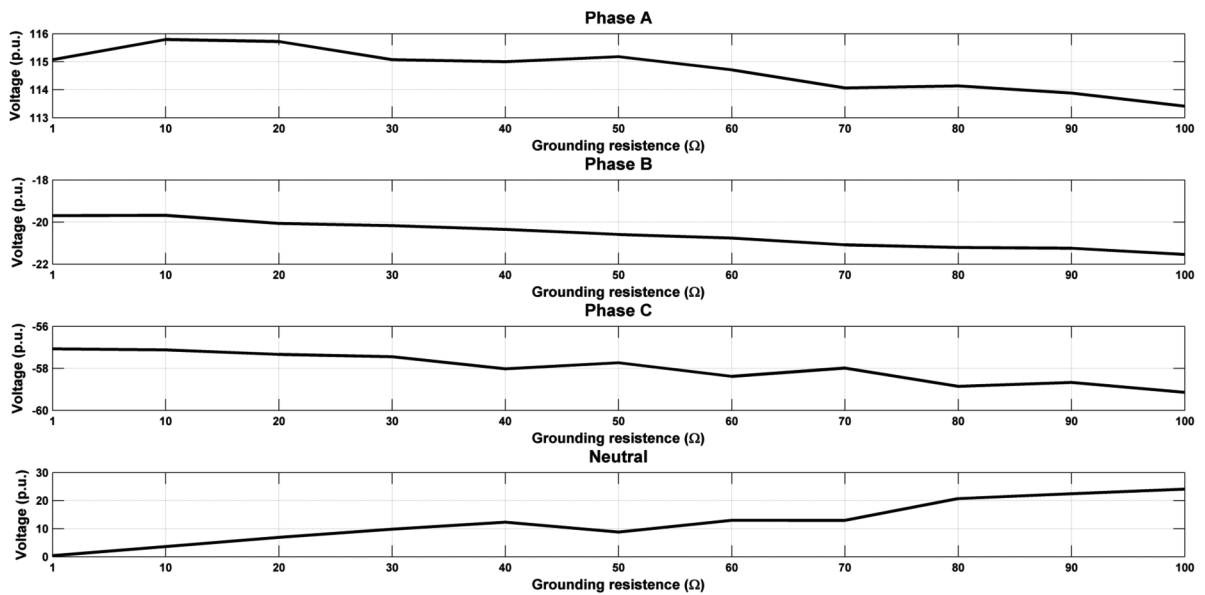


Figure 3. Phase surges relative to ground resistance for residential loads

Source: Own work.

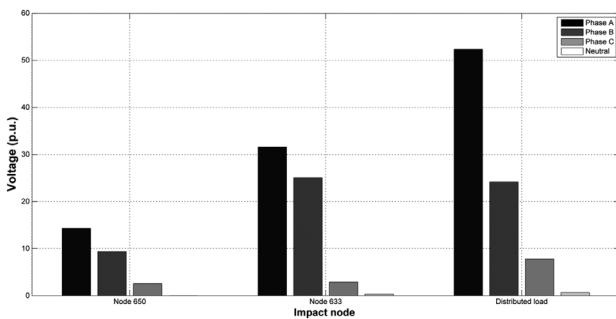


**Figure 4.** Phase surges relative to ground resistance for industrial loads

Source: Own work.

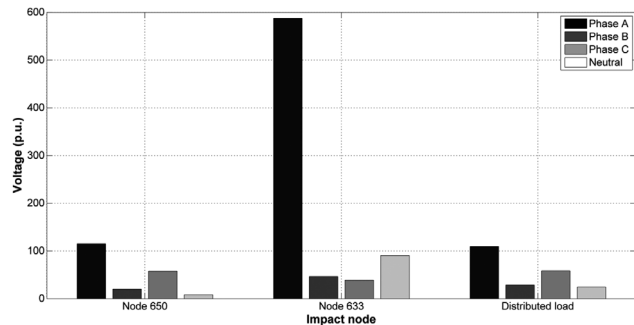
### Case 2: fixed low voltage grounding resistance and variable lightning strike point

Figure 5 and Figure 6 show the surges at 90% of the peak value, recorded in residential load phases and industrial load phases, respectively, with respect to neutral and neutral with respect to ground, for different lightning strike injection points.



**Figure 5.** Surges in each residential load phase, with respect to neutral and neutral with respect to ground

Source: Own work.



**Figure 6.** Surges in each industrial load phase, with respect to neutral and neutral with respect to ground

Source: Own work.

Surges produced by disturbances in several points of the system, and recorded in the residential load, confirm that for grounding resistance lower than 25 Ω, the grounding potential level can be tolerated by electronic devices (Ministerio de Minas y Energía, República de Colombia, 2008).

Surge recorded in phase A when a lightning transient occurs in node 633 reaches levels up to

four times the ones recorded in other nodes of industrial load. This is due to the low impedance between the impact point and the register point, together with the non-transposed lines, as shown in figure 6.

**Case 3: Opening phase A of industrial load. Low voltage grounding resistance kept constant and simultaneous measurement at different points of the system**

Table 7 and Table 8 show the magnitudes at 90% of peak value and rise time of surge between each phase and neutral measured in the residential and industrial load, when a surge is generated by phase A opening of industrial load.

**Table 7.** Switching surges in industrial load

Surge Register	Magnitude at 90% (p.u)	Rise-time (µs)
Phase A – Neutral	3243,22	0,98
Phase B – Neutral	371,30	2,99
Phase C – Neutral	373,80	2,86
Neutral – Ground	25,90	0,90

Source: Own work.

**Table 8.** Switching surges in residential load

Surge Register	Magnitude at 90% (p.u)	Rise-time (µs)
Phase A – Neutral	1,53	29,18
Phase B – Neutral	1,30	29,22
Phase C – Neutral	0,023	19,14
Neutral – Ground	0,027	41,33

Source: Own work.

Slow front surges produced by switching the phase A, depends on time when the switch opens and the arc dynamic behavior at the same time (Indulkar, Thomas, & Bijwe, 1992). According to table 7, in the industrial load the surge magnitude in phase A is ten times higher than the recorded in phases B and C. This is due to the inductive load rises the voltage level in response to abrupt current

changes. Furthermore, induced surges in the other circuit phases are exponentially attenuated with respect to the network characteristic impedance. Table 7 and table 8 show the surge values in phase B (371,3 p.u. and 1,3 p.u., respectively).

Colombian standard for internal surge protection systems (NTC 4552 Protección contra rayos, 2004), shows the impulse voltage values that devices must withstand according to their operation levels. For Colombian power system at residential low voltage, the impulse values would be equal to or less than 2,5 kV. This value was exceeded in the first two simulation cases; therefore, surge protection devices are required. Proper design of protection devices as diodes, thyristors, surge protectors, etc., must follow appropriate selection criteria. For protection of electronic devices at residential load, three diodes with different characteristics were selected. Type I is an avalanche diode, type IIA and IIB are non-avalanche diodes, as shown in table 9 (Chowdhuri, 1996).

**Table 9.** Susceptibility data for transient voltages in three types of high power diodes

Diode type	I	IIA	IIIB
Peak Reverse Voltage PRV (V)	1200	800	1200
Transient PRV (V)	-	1250	1500
Direct current (A)	250	250	250
Reverse Break-down voltage (V)	2350/2500	1620/1200	1950/1650

Source: (Chowdhuri, 1996).

**CONCLUSIONS**

Surge magnitude depends on distance to impact point, regardless if load is industrial or residential, at shorter distances, greater magnitudes.

Design values of grounding resistance for residential loads must be less than 25 Ω, in agreement with Colombian regulation standards. Surge registered in neutral line presents a linear behavior with respect to grounding resistance value. This linear



behavior enables a proportionality constant to predict the surge level at neutral. However, in the phases the behavior is not predictable, making impossible to use a proportionality constant.

Signals recorded from ATP simulations show the importance of measuring and characterizing the overvoltages in low voltage systems, in order to determine the origin of these surges and possible strategies to reduce their negative effects. According to the registered magnitudes, it is necessary to calculate and implement protective devices designed to protect the life of sensitive equipment installed in the low voltage system.

## REFERENCES

- Antunes Tavares, K. & Melo e Silva, K. (2014). Evaluation of power transformer differential protection using the ATP software. *IEEE Latin America Transactions*, 12(2), 160-168.
- Bachega, R. & Martínez, M. (2004). Transformer Modeling for Transferred Voltages. *Transmission and Distribution Conference and Exposition: Latin America, 2004 IEEE/PES*.
- Borghetti, A. et al. (2009). Lightning-Induced Overvoltages Transferred Through Distribution Power Transformers. *Power Delivery, IEEE Transactions on*, 24(1), 360-372.
- Borghetti, A. et al. (2006). Lightning-Induced Overvoltages Transferred from Medium-Voltage to Low-Voltage Networks. *Power Tech*. St. Petersburg.
- Chowdhuri, P. (1996). *Electromagnetic transients in power systems*. New York: John Wiley & Sons INC.
- CIGRE Working group 33.02. (1990). Guidelines for representation of network elements when calculating transients. *Technical brochure 39*.
- Cooray, V. (2003). *The lightning flash*. London: The institution of engineering and technology.
- Costa Quintana, J. & López Aguilar, F. (2007). *Interacción electromagnética teoría clásica*. Barcelona: Reveté, S.A.
- Das, J. (2010). *Transients in electrical systems*. New York: McGraw-Hill.
- De Contí, A. & Visacro, S. (2005). Evaluation of lightning surges transferred from medium voltage to low-voltage networks. *Generation, Transmission and Distribution, IEE Proceedings*, 152(3), 351-356.
- Escamilla, J., Gomez, P. & Tejada, C. (2009). Single-Phase Transformer Modeling for Analyzing Transient Overvoltages Distribution and Transference. *Latin America Transactions, IEEE*, 7(5), 545-551.
- Gómez, P. (2013). Performance evaluation of time domain transmission line models for a statistical study of switching overvoltages. *IEEE Latin America Transactions*, 11(4), 1036-1046.
- Herrera, J., Perez, E. & Torres, H. (2003). Statistical evaluation of transferred voltages through transformers due to lightning induced overvoltages. *Power Tech Conference Proceedings, 2003 IEEE Bologna*. Bologna.
- IEEE PES Distribution System Analysis Subcommittee's Distribution Test Feeder Working Group. (2000-2010). *IEEE Power and Energy Society*. (IEEE) Acceso em 02 de 11 de 2013, disponível em [ewh.ieee.org/soc/pes/dsacom/testfeeders/index.html](http://ewh.ieee.org/soc/pes/dsacom/testfeeders/index.html)
- IEEE standards association. (2011). *IEEE guide for improving the lightning performance of electric power overhead distribution lines*. New York: IEEE Power & energy society.
- IEEE Std 1159 Recommended practice for monitoring electric and power quality. (2009). New York: The Institute of Electrical and Electronics Engineers, Inc.
- IEEE Std 446 Recommended practice for emergency and standby power systems for industrial and commercial applications. (1995). New York: The Institute of Electrical and Electronics Engineers, Inc.
- Indulkar, C., Thomas, M. & Bijwe, P. (1992). switching overvoltages in a three-phase transformer. *Circuits and Systems, 1992., Proceedings of the 35th Midwest Symposium on*. Washington, DC.
- Justo de Araújo, A., Cleber da Silva, R. & Kurokawa, S. (2013). Representation of transmission lines: a comparison between th model distributed parameters and lumped parameters. *IEEE Latin America Transactions*, 11(4), 1047-1052.

- Liu, T. & Scott, W. (1994). *Electro magnetic transients program (EMTP) Theory book*. Portland: Bonneville power administration.
- Martínez, J. (2008). *Coordinación de aislamiento en redes eléctricas de alta tensión*. Madrid: McGraw-Hill.
- Martínez, J. (2010). *Power system transients parameter determination*. CRC Press.
- Ministerio de Minas y Energía, República de Colombia. (2008). Reglamento técnico de instalaciones eléctricas. *RETIE*. Bogotá, Colombia: Ministerio de Minas y Energía, República de Colombia.
- Morched, A., Martí, L. & Ottevangers, J. (1993). A high frequency transformer model for the EMTP. *IEEE Transactions on power delivery*, 8(3), 1615-1626.
- NTC 4552 Protección contra rayos. (2004). Bogotá, DC: ICONTEC.
- Papadias, B., Hatzargyriou, N. & Prousalidis, J. (1993). Transformer Modeling for Switching Overvoltages. *Athens Power Tech, 1993. APT 93. Proceedings. Joint International Power Conference*. Athens.
- Pham, T., Pham, N. & Tran, V. (2010). EMTP Simulation of Induced Overvoltage in Low Voltage System. *Electrical Insulation (ISEI), Conference Record of the 2010 IEEE International Symposium on*, 1-4. San Diego, CA.
- Piantini, A. (2010). Lightning protection of low-voltage networks. In V. Cooray, *Lightning protection*, 553-611. London: The Institution of Engineering and Technology.
- Piantini, A. (2010). Lightning protection of low-voltage networks. *Lightning protection*, 553-634. London: The Institution of Engineering and Technology.
- Scott, W. & Liu, T. (1992). *Alternative transients program ATP Rule Book*. Portland: Canadian/American EMTP User Group.
- Varju, G. & Ladanyi, J. (2007). Transient Power Frequency Overvoltages Transferred to Low Voltage Networks From the EPR of HV and MV Transformer Stations. *Electromagnetic Compatibility and Electromagnetic Ecology, 2007 7th International Symposium on*. Saint-Petersburg.
- Watson, N. & Arrillaga, J. (2007). *Power systems electromagnetic transients simulation*. London: Institution of Engineering and Technology.

## FUNDING

This work was supported by Universidad Distrital Francisco José de Caldas.

## Embedded wavelet analysis of non-audible signals

### Análisis embebido por ondículas de señales no audibles

Andrés Camilo Ussa Caycedo\*, Olga Lucía Ramos Sandoval\*\*,  
Darío Amaya Hurtado\*\*\*, Jorge Enrique Saby Beltrán\*\*\*\*

**Fecha de recepción:** June 10th, 2014

**Fecha de aceptación:** November 4th, 2014

**Citation / Para citar este artículo:** Ussa Caycedo, A. C., Ramos Sandoval, O. L., Amaya Hurtado, D., & Saby Beltrán, J. E. (2014). Embedded wavelet analysis of non-audible signals. *Revista Tecnura*, 18 (Edición especial doctorado), 51–60. doi: 10.14483/udistrital.jour.tecnura.2014.DSE1.a04

#### ABSTRACT

The analysis of non-audible signals has gained a significant importance due to their many fields of application, among them, speech synthesis for people with speech disabilities. This analysis can be used to acquire information from the vocal apparatus without the need of speaking in order to produce a phonetic expression. The analysis of a Wavelet transformation of Spanish words recorded through a non-audible murmur microphone in order to achieve an embedded silent speech recognition system of Spanish language is proposed. A non-audible murmur microphone is used as sensor of non-vocal speech. Coding of the input data is done through a Wavelet transform using a fourth-order Daubechies function. The acquisition, processing and transmission system is applied through a STM32F4-Discovery evaluation board. The used vocabulary consists of command words aimed to control mobile robots

or human-machine interfaces. The Wavelet transformation of four Spanish words, each of them having five independent samples, was accomplished. An analysis of the resulting data was performed, and features as average, peaks and frequency were distinguished. The processing of the signals is performed successfully and further work in speech activity detection and features classifiers is proposed.

**Keywords:** Communication Aids for Disabled, Esophageal, Phonetics, Speech, Wavelet Analysis.

#### RESUMEN

El análisis de señales no audibles ha ganado una importancia significativa debido a la gran cantidad de aplicaciones que estas tienen, como la síntesis de voz para personas con discapacidad del habla. Este análisis puede ser usarse para

\* Mechatronics Engineer, Research Assistant, Universidad Militar Nueva Granada, Engineering Faculty Mechatronics Engineering Program, Bogotá D.C., Colombia E-mail:u1801205@unimilitar.edu.co

\*\* Electronics Engineer, Electronics Instrumentation Specialization, Master in Teleinformatics Universidad Militar Nueva Granada, Engineering Faculty-Mechatronics Engineering Program, Bogotá D.C., Colombia. E-mail: olga.ramos@unimilitar.edu.co

\*\*\* Electronics Engineer, Specialization in Industrial Process Automation, Master in Teleinformatics, Mechanical Engineering PhD., Universidad Militar Nueva Granada, Engineering Faculty Mechatronics Engineering Program, Bogotá D.C. E-mail:dario.amaya@unimilitar.edu.co

\*\*\*\* Bachelor Degree in Linguistics and Literature, Specialization in n Semiotics, master in Spanish Linguistics, Linguistics and letter PhD., Science of Education PhD., Universidad Distrital Francisco José de Caldas, Bogotá D.C., Colombia. E-mail:jesabyb@udistrital.edu.co

adquirir información del aparato fonador sin la necesidad del habla, para así producir una expresión fonética. Para esto se propone el análisis de la transformada de ondícula de palabras del español a través de un micrófono de murmurio no audible para el desarrollo de un sistema embebido de reconocimiento del habla silenciosa. Se usa un micrófono de murmurio no audible como sensor del habla no vocal. La codificación de los datos de entrada se realiza a través de una transformada de ondícula usando una función Daubechies de cuarto orden. El sistema de adquisición, procesamiento y transmisión se realiza a través de una tarjeta de evaluación ST-M32F4-Discovery. El vocabulario utilizado consistía

de palabras de mando orientadas al control de robots móviles o de interfaces hombre-máquina. Se desarrolló exitosamente la transformada de ondícula de cuatro palabras del español, cada una con cinco muestras independientes. Se realizó un análisis de los datos obtenidos, y se discutieron características como el promedio, los picos y la frecuencia. El procesamiento de las señales se ejecutó de manera exitosa y se proponen futuros trabajos en la detección de la actividad del habla y clasificadores de características.

**Palabras clave:** análisis de ondículas, equipos de comunicación para personas con discapacidad, fonética, habla, voz esofágica.

## INTRODUCTION

Research and development of automatic silent speech recognition systems had raised several approaches over the years. Along with electromyography (EMG), the Non-audible murmur (NAM) microphone is one of the more promising (Tomoki *et al.*, 2009). This is due to its robustness against external noise, ease of using, low cost and non-invasive nature. It can be used to detect low amplitude sounds produced by air flow through the larynx, this way being a useful tool in speech synthesis that requires low or null sound made. In order to elaborate a silent speech recognition system, a way to code and analyze the acquired signals is required. A multi-resolution analysis through the Wavelet transform is proposed because of its feature characterization properties, easy implementation and wide use in this kind of applications. This study's goal is to embed the system in an electronic device, that's why acquisition, processing and transmission were performed in a ST evaluation board. This work describes previous work in this matter, the technology and techniques utilized while development and the results obtained when implemented.

A NAM microphone is a high sensitivity microphone which is adhered to the human skin and acts as a stethoscope. This is encapsulated by a soft silicone material, allowing the improvement of the impedance between the microphone's diaphragm and the skin, and avoiding the noise caused by clothes or other objects (Denby *et al.*, 2010). The unit sensor is an electret capacitor without metallic cover to allow direct contact between the diaphragm and the silicone. Studies with this kind of microphone showed the proper placement of it was on the side of neck because this way it could capture vibrations from resonance caused by the vocal tract when the air flowed (Babani, Tomoki, Hiroshi & Kiyohiro, 2011).

The discrete Wavelet transform is a fast, linear operation that operates on a data vector whose length is an integer power of two, transforming it into a numerically different vector of the same length (Abair & Alimbayev, 2014). A diagram of this process can be seen in figure 1. The Wavelet transform is invertible and orthogonal. In the Wavelet domain, the basic functions have the names "mother functions" and "wavelets". Individual Wavelet functions are localized in space and simultaneously, localized in frequency or

characteristic scale. Wavelets are defined by the Wavelet function  $\psi(t)$  (i.e. the mother Wavelet) and scaling function  $\phi(t)$  (also called father Wavelet) in the time domain. Each of these functions is specified by a particular set of numbers, called Wavelet filter coefficients. The scaling function acts like a low pass filter which gets the «smooth» information, and the Wavelet function acts as a high pass filter which gets the «detail» information. A discrete Wavelet transform is defined in equation (1) (Xinyi, Gengyin, Ming, & K.I., 2011).

$$S = \int_{-\infty}^{\infty} \psi'(t) s(t) dt, \quad (1)$$

Where  $\psi(t)$  is the Wavelet function and  $s(t)$  a real signal. And where  $\psi'$  denotes the complex conjugate of  $\psi$ .

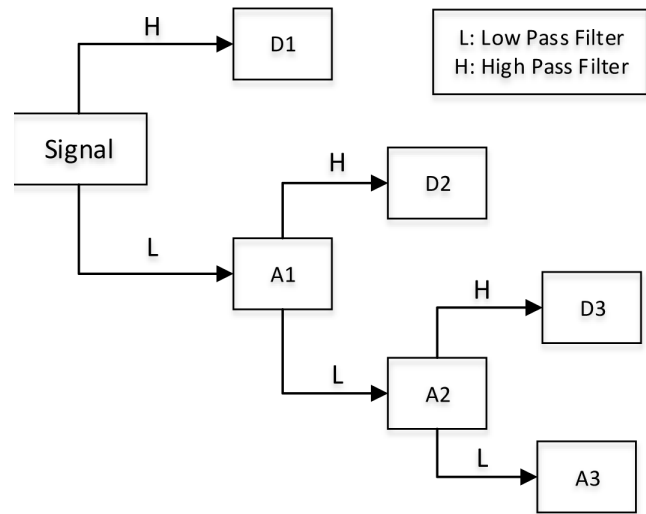
A popular mother function, the Daubechies Wavelet function, is defined in equation (2).

$$\psi(t) = \sum_{k=-\infty}^{\infty} \beta_k \sqrt{2} \phi(2t - k), \quad (2)$$

Where  $\phi(t)$  is the scaling function which is defined in equation (3) and  $\beta$  is the Wavelet sequence.

$$\phi(t) = \sum_{k=-\infty}^{\infty} \alpha_k \sqrt{2} \phi(2t - k), \quad (3)$$

Where  $\alpha$  is the scaling sequence. Then, the discrete Wavelet transform consists of applying the Wavelet and scaling functions, first to the full data vector of length  $N$ , then to the “smooth” vector of length  $N/2$ , then to the “smooth-smooth” vector of length  $N/4$ , and so on until only a trivial number of “smooth-. . .-smooth” components (usually two) remain (Abair & Alimbayev, 2014). The output of the transformation consists of these remaining components and all the “detail” components that were accumulated along the way.



**Figure 1.** Wavelet transform process

**Source:** Own work.

A real-time operating system (RTOS) was implemented within the evaluation board. A RTOS is responsible for managing the hardware resources of the tasks running in the system with very precise timing and a high degree of reliability (Instruments, 2013). The RTOS kernel supplies four main types of basic services to application software: Inter Process communication (IPC) and synchronization, time management, dynamic memory allocation and task management (Laplante & Ovaska, 2011). It must have a known maximum time for each of the critical operations that it performs, engaging for this matter OS calls and interrupt handling. Each task is set with a specific priority, that way defining when each task will take place. This allows the development to be timing controlled, extensible, modular and easier to control interrupts and peripherals (FreeRTOS, 2013).

The remaining of this paper goes as follows. Some previous work regarding wavelets applications is presented in section two. The methodology followed is described in section three. The results are presented in section four, and lastly the conclusions in section five.



## Previous work

Research regarding Wavelet analysis of signals is numerous. This technology has found a constant presence in diverse studies in the later years. Applications can be found in medicine, image processing, signal filtering, speech synthesis and classification, among others. It is a very useful technique that is permanently growing and finding more fields to perform. Some related research is as follows.

Some applications in the medical field are related to heart diseases. In 2007 (de Vos & Blanckenberg, 2007), aimed to discriminate between pathological and non-pathological heart sounds in child, through an automated artificial neural network as well as a direct ratio and a Wavelet analysis technique applied in electronic auscultation signals. Their objective was to help non-specialist physicians to evaluate heart murmurs with higher confidence. They used Wavelet analysis to reduce noise in input data, which was heart sound and electrocardiogram signals. This was done through a Daubechies Wavelet of order five (db5) with a decomposition level of eight. Wavelets were also used to analyze certain characteristics of the input data, where direct systolic energy values were taken to serve as an indicator. The fourth-order Daubechies Wavelet (db4) was used for this purpose.

Three years later, Choi, Shin *et al.* (Samjin, Youngkyun & Hun - Kuk, 2011) used a Wavelet package in which four features were analyzed: maximum peak frequency (MPF), the position index of Wavelet packet coefficient corresponding to MPF, and the S1nS2 to murmur ratios of energy and entropy. S1nS2 are heart sounds that are always audible and appear at very high amplitudes in normal subjects. And their objective was to identify aortic insufficiency and insufficiency murmurs (IM) using the resulting Wavelet decomposition. The input data for the experiment was a data set of normal and IM sounds, and recorded sounds using a wireless electric stethoscope from healthy subjects and heart disease patients. Their results

suggested their novel IM identification method was applicable to clinical environments.

Another study regarding cardiac diseases was presented by Verma, Cabrera, Mayorga, & Nazeran (2013), where a robust algorithm was developed to derive heart rate variability from electrocardiogram or photoplethysmographic signals, in order to ease its digital spectral analysis which provides quantitative markers of the autonomic nervous system. An undecimated Discrete Wavelet Transform Daubechies-6 family of filters was used to selectively remove some of the high-frequency subbands from the signals. Wavelet transform was also used by Suresh & Balasubramanyam (2013) as a feature extractor of raw electroencephalography (EEG) data where transient features were accurately captured and localized in both time and frequency context. The mother Wavelet chosen was the fourth-order Daubechies. The objective was to detect peaks, which are related to head injuries and epilepsy. This was successfully achieved using neural networks based on Wavelet transform as a preprocessor.

Wavelet properties also allowed it to be used in the implementation of human interfaces. The following are some examples Satiyan, Hariharan, & Nagarajan (2010) investigated the performance of a Daubechies Wavelet family in recognizing facial expressions. The input data were 2D coordinates recorded from the movements of luminance stickers on the face while performing facial expressions. The Wavelet was applied with different orders, from db1 to db20. The standard deviation of the resulting approximation coefficients was used as input of a neural network to classify over eight facial expressions. The average maximum recognition rate of facial expression was 97% for the Daubechies Wavelet order one.

A research work regarding a silent speech interface also took advantage of wavelets features (Torres, Reyes & Villaseñor, 2012). Their intention was to interpret electroencephalography (EEG) signals associated with actions to imagine the pronunciation of words that belong to a reduced

vocabulary without moving the articulatory muscles and without uttering any audible sound. The recorded vocabulary reflects movements to control the cursor on a computer, and the discrete Wavelet transform was used to extract features from the delimited windows. The subsets were used to train classifiers. They obtained evidence to affirm that EEG signals carry useful information to allow the classification of unspoken words.

It can be seen from some research works using wavelets that this technique is very useful for the processing of biological signals for its denoising, processing and classification, and that Daubechies Wavelet is vastly used for its easy implementation and suitable features for signal analysis.

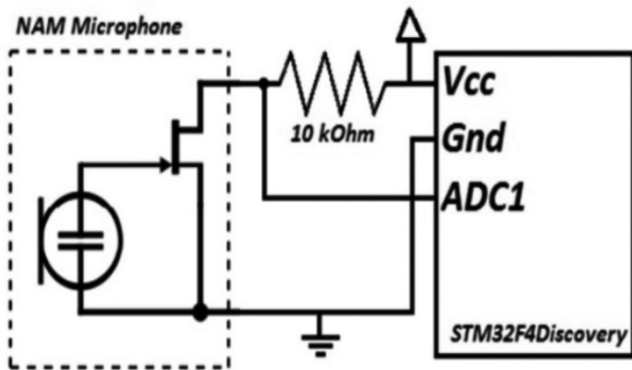
## METHODOLOGY

The method to apply a Wavelet transform on signals acquired by a NAM microphone can be divided in three stages. The first stage consists of the analog-digital conversion (ADC) of the signals coming from the sensor. The second stage consists of applying the Wavelet transform and transmitting its output to a PC through USB. And the third stage consists of receiving the USB data and store it for further analysis. The STM32F4-Discovery evaluation board (from this point onward, the "Discovery board") was used as the input data collector and data transmitter; it was also in charge of applying the Wavelet transform. A C# graphic user interface was designed for data reception and storing. The sensor used to acquire the murmur signals was a Non-Audible Murmur microphone.

One male subject Spanish speaker participated in the experiment. He was informed about the microphone's operation, the way of utterance and the vocabulary used in the test. The NAM microphone was placed below the ear, against the side of the neck. The vocabulary recorded consisted of four Spanish words: "adelante", "atrás", «derecha» and «izquierda», which translate forward,

backwards, right and left, respectively. These words were chosen due to the intention of using this silent speech interface for mobile robots control. Five recordings of each word were acquired, each recording lasting approximately five seconds. In order to select the data range in which the transformation would be applied, the data recorded was directly stored in a computer. The period of the ADC was 1.5 milliseconds, which means the conversion was performed at a 666 Hz rate. This resulted in a 3300 data size approximately for each recording, from which 1024 data with valuable information was manually identified and extracted in order to be processed subsequently. A Wavelet transform was applied over each data sample; this was performed by the Discovery board, which transmitted the output back to the PC through USB.

The Discovery board consists of a 32-bit ARM Cortex-M4F core microcontroller, with 1 MB Flash and 192 KB RAM, along with some functions, among them the ADC and USB modules. Keil's MDK-ARM software development environment was used for the Discovery board programming. A Real-time operating system was implemented within the board for task managing, the chosen RTOS was FreeRTOS due to its professional development, strictly quality control, robustness, support, and free to use (FreeRTOS, 2013). Three tasks were implemented: the USB task, the ADC task and the Wavelet transform task; along with peripherals and interrupts configuration. The USB task was set with a higher priority level than the other tasks, since it was imperative to send and receive data when it was available. Two queues were created to handle data shared between tasks, a queue to allocate the input data acquired from the analog to digital conversion or from the received USB buffer, and another to allocate the output of the Wavelet transform to the transmission function. ADC and USB interrupts were also employed.



**Figure 2.** Electric circuit

**Source:** Own work.

The ADC task was performed continuously; it had a 12-bit resolution, sampled the input voltage for 480 Cycles and had an end of conversion interrupt which was set in order to store the measured value. The USB module was configured with the communication device class (CDC) at full speed, as well as the related interrupt for reception. The system’s configuration can be seen in Figure 2, the microphone was connected in series circuit to a 10k resistor, having 3V as voltage source. The discovery board was powered through USB.

A Wavelet transformation was chosen as the signal coding method because of its property to offer simultaneous time and frequency analysis, its ability to decompose a signal in fine details (Abair & Alimbayev, 2014), and due to previous successful approaches in signal and speech analysis and characterization. The mother Wavelet used in this process was the Daubechies orthogonal Wavelet of four coefficients (daub4), this specific function allowed a fast implementation and proper feature extraction (MAdishetty, MAdanayake, & Cintra, 2013). The action done on the input vector is to perform two related convolutions, one with  $c_0, \dots, c_3$  (scaling coefficients) which act as a smoothing filter and the other with  $c_3, -c_2, c_1, -c_0$  (Wavelet coefficients) which gives detail information, then to decimate each of them by half, and interleave the remaining halves. And then applying the

procedure to the resulting “smooth” vectors, and so on, until only two values are reached.

The daub4 coefficients are shown in equation (4).

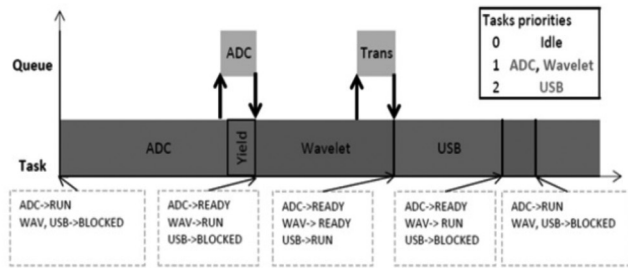
$$C_0 = 0,48296291 \quad C_1 = 0,83651630 \\ C_2 = 0,22414386 \quad C_3 = -0,12940952 \quad (4)$$

The Wavelet task was constantly waiting for the queue to fill with an input float 1024 length vector; hence this procedure was only performed when the data was ready to be processed. The output was then assigned into the transmission queue, in a string format; this way saving memory space and easing the sending protocol. Due to the space required to use a float array of 1024 length, allocation and clear memory functions were actively used. This way stack overflow and memory allocation failures were avoided.

The following is the logic sequence of the program: The ADC task starts performing the conversion and when it finishes getting all the converted values occurred during a certain amount of time, it assigns the generated array into the ADC queue, and goes to ready state allowing the next task to run. The next task, being the Wavelet task, was indefinitely blocked waiting for the queue to get filled, and when it is ready to run it takes the input string and converts it to a float data type, in order to prepare the data for its processing. The Wavelet transform is performed on the data, and an array of same size is the result. This is then allocated in the transmission queue, which the USB task was waiting to get filled, for it to get unblocked and running. This happens immediately since the USB task has a higher priority than the other tasks, hence it blocks the Wavelet task. Just as it finishes sending the data to the PC, the Wavelet task completes its operation and then yields, allowing the process to start over again. A schematic of the whole process is showed in Figure 3.

The tasks were designed to be used in such a way the non-audible murmur processing could be performed solely by the Discovery board, without

needing any assistance of external devices. Although, this approach is not yet implemented since it is necessary to design a trigger for speech activity detection. Instead, the range in which the speech information took place was manually selected, always obeying the required input data length, and later passed to the Discovery board.



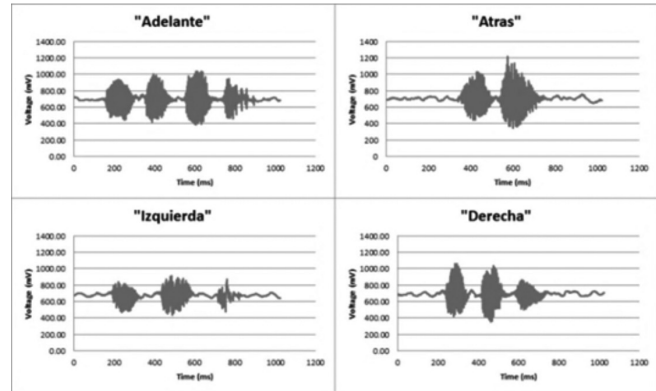
**Figure 3.** Tasks operation

Source: Own work.

## RESULTS

Each set of words was successfully processed, resulting in a dataset of five transformations per word. Since some of the words used in the experiment have the same number of syllables, input data from those can get to seem similar, as one can see in Figure 4 comparing “Izquierda” to “Derecha”. Dissimilarity can be achieved by coding the signals through the Wavelet transform and analyzing certain features (e.g. standard deviation, average) of the output values, in order to discriminate among the vocabulary. Another feature to take into account is the amount of silent time, which in this case happens before and after the recorded data. This time exists because the recording lasted the same period for all the words, causing the shorter words to have longer silent intervals, and the longer words the opposite. In this case the word “Atrás» is the shorter word; consequently, it also presents the longer silent period. This experiment’s specific circumstance also affects the transform output, and may cause issues in further intentions to classify the words. This is why it is mandatory to

start recording as long as the utterance begins, that way registering only the useful information and additionally saving resources of the system.



**Figure 4.** Samples of Input signals

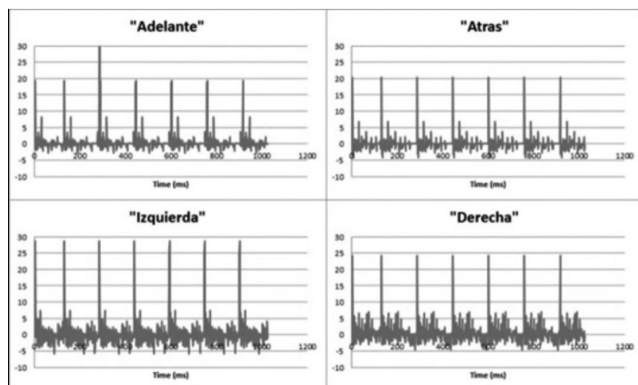
Source: Own work.

The Wavelet transform of the sample input signals presented in Figure 4 can be seen in figure 5. All results show evident constant frequency high peaks; these peaks’ amplitude varied depending on the word, but have equal recurrence due to the nature of the mother Wavelet. The words “Adelante” and “Atrás» have similar magnitudes for their higher peak in contrast to the other words; this could suggest that those peaks depend on the first syllable of a word.

It can be observed that regardless some input signals were similar, their outputs present some substantial differences marks (e.g. amplitude, frequency) that can be exploited in order to find a proper feature for further classification. For example, the words «Izquierda» and «Derecha» have the same amount of syllables; so they can be differentiated due to the average value of the signal, or the amount of peaks (high and low) they present. Some common feature extraction methods are moving root mean square (Basavaraj & Veerappa, 2009), short time Fourier transform (Junhong & Ming, 2010), linear predictive coefficients (Patnaburi, Onshaunjit & Srinonchat, 2012), Zero-crossing points (Lopez - Larraz, Mozos, Antelis, &



Minguez, 2010), among others. This extraction can also be performed by a combination of the previously stated techniques.



**Figure 5.** Output signals

**Source:** Own work.

Concerning the consistency in the results associated with a specific word, output signals remained fairly constant. The words that had the most constant results were “Adelante” and “Atrás», the other two words had variability in their amplitude and average, not in its frequency. This aftermath can be related to the conditions in which the test was developed, a more controlled environment could lead to better results. Another cause of this is the not yet implemented speech activity detection, where manual selection was employed instead; subjectivity and inconsistency are consequences of this. Even applying that last component, it must be also considered the speed in which the words are pronounced, and the variation it can induce between same word recordings. If one manages to identify one word with a certain tone and speed, that same word may not be identified if the utterance’s volume or duration changes. That is why this feature of the input data should get confronted and overcome by applying a time-domain feature extraction technique that deals with this situation.

## CONCLUSIONS

A Wavelet analysis on non-audible signals of four Spanish words captured by a NAM microphone

was made. The objective was to design a system in which a device could acquire, process and transmit Wavelet processed signals. The signals were successfully captured and transformed into their Wavelet counterpart. The acquired signals were manually selected so only the part with valuable information could be processed. This could be done automatically by the device if a speech activity detector was implemented. Studies in this matter will be done in the future. A standardize method for the development of the experiment is suggested. This relates to specify the exact position of the microphone in the neck (same for all subjects), determine a controlled space to perform it, safe from noise and disruptions, and establish the process in which the pronunciation should be done, testing different tones and duration. All these measures should lead to better quality tests, avoiding subjectivity and inconvenient at best. The next step for automatic speech recognition to be accomplished is to design a classifier which uses features of the resulted signals to discriminate and identify Spanish words. In order to get a better understanding of its operation, studies with an extended vocabulary and different mother wavelets will be performed.

## REFERENCES

- Abair, D. & Alimbayev, T. (2014). Conjugate Heat Transfer in a Developing Laminar Boundary Layer. *Proceedings of the World Congress on Engineering 2014, II*, London, UK. Retrieved October 10, 2014, from [http://www.iaeng.org/publication/WCE2014/WCE2014\\_pp1387-1392.pdf](http://www.iaeng.org/publication/WCE2014/WCE2014_pp1387-1392.pdf)
- Babani, D., Tomoki, T., Hiroshi, S. & Kiyohiro, S. (2011). Acoustic model training for non-audible murmur recognition using transformed normal speech data. In IEEE (Ed.), *2011 IEEE International Conference on Acoustics, Speech and Signal Processing (ICASSP)*, 5224 - 5227. Prague. doi:10.1109/ICASSP.2011.5947535
- Basavaraj, S. & Veerappa, B. P. (2009). An acoustic signature based neural network model for type recognition of two-wheelers. *2009. IMPACT '09*.



- International Multimedia, Signal Processing and Communication Technologies*, Aligarh: IEEE. doi:10.1109/MSPCT.2009.5164166
- de Vos, J. & Blanckenberg, M. (2007). Automated Pediatric Cardiac Auscultation. (IEEE, Ed.) *IEEE Transactions on Biomedical Engineering*, 54(2), 244 - 252. doi:10.1109/TBME.2006.886660
- Denby, B. et al. (April 2010). Silent speech interfaces. *Speech Communication*, 52(4), 270-267. doi:10.1016/j.specom.2009.08.002
- FreeRTOS. (2013, June 6). *FreeRTOS*. Retrieved September 30, 2014, from <http://www.freertos.org/FAQWhat.html#WhyUseRTOSFAQWhat.html>
- Instruments, N. (2013, November 22). *National Instruments*. Retrieved October 5, 2014, from <http://www.ni.com/white-paper/3938/en/>
- Junhong, D. & Ming, Y. (2010). Analysis of guided wave signal based on LabVIEW and STFT. *2010 International Conference on Computer, Mechatronics, Control and Electronic Engineering (CMCE)*, 5, 115-117. Changchun: IEEE. doi:10.1109/CMCE.2010.5610045
- Laplante, P. & Ovaska, S. (2011). Concepts and misconceptions. In Wiley (Ed.), *Real-Time Systems Design and Analysis: Tools for the Practitioner*, 4th ed., 5-8, United States of America: IEEE. Retrieved October 7, 2014, from [https://books.google.com.co/books?hl=es&lr=&id=Ez6-aSfbqtsC&oi=fnd&pg=PR15&dq=Real-Time+Systems+Design+and+Analysis:+Tools+for+the+Practitioner.&ots=V4\\_Vm-UbDy&sig=o3bFajr9lh6z6oIFuJrn-Pr7V5Q#v=onepage&q=Real-Time%20Systems%20Design%20and%20Analysis%3A%20](https://books.google.com.co/books?hl=es&lr=&id=Ez6-aSfbqtsC&oi=fnd&pg=PR15&dq=Real-Time+Systems+Design+and+Analysis:+Tools+for+the+Practitioner.&ots=V4_Vm-UbDy&sig=o3bFajr9lh6z6oIFuJrn-Pr7V5Q#v=onepage&q=Real-Time%20Systems%20Design%20and%20Analysis%3A%20)
- López - Larráz, E., Mozos, O., Antelis, J., & Minguez, J. (2010). Syllable-based speech recognition using EMG. *2010 Annual International Conference of the IEEE Engineering in Medicine and Biology Society (EMBC)*, 4699-4702, Buenos Aires: IEEE. doi:10.1109/IEMBS.2010.5626426
- MAdishetty, S. K., MAdanayake, A. & Cintra, R. (2013, June). Architectures for the 4-Tap and 6-Tap 2-D Daubechies Wavelet Filters Using Algebraic Integers. *IEEE Transactions on Circuits and Systems I: Regular Papers*, 60(6), 1455-1468. doi:10.1109/TCSI.2012.2221171
- Pattanaburi, K., Onshaunjit, J. & Srinonchat, J. (2012). Enhancement Pattern Analysis Technique for Voiced/Unvoiced Classification. *2012 International Symposium on Computer, Consumer and Control (IS3C)*, 389-392. Taichung: IEEE. doi:10.1109/IS3C.2012.105
- Samjin, C., Youngkyun, S. & Hun - Kuk, P. (2011, April). Selection of wavelet packet measures for insufficiency murmur identification. *Expert Systems with Applications*, 38(4), 4264- 4271. doi:doi:10.1016/j.eswa.2010.09.094
- Satiyan, M., Hariharan, M. & Nagarajan, R. (2010). Comparison of performance using daubechies wavelet family for facial expression recognition. *2010 6th International Colloquium on Signal Processing and Its Applications (CSPA)*, 1-5. Mallaca City: IEEE. doi:10.1109/CSPA.2010.5545262
- Suresh, H. & Balasubramanyam, V. (2013). Wavelet transforms and neural network approach for epileptical EEG. *2013 IEEE 3rd International Advance Computing Conference (IACC)*. Ghaziabad: IEEE. doi:10.1109/IAdCC.2013.6506807
- Tomoki, T., Keigo, N., Takayuki, N., Tomomi, K., Yoshitaka, N. & Kiyohiro, S. (2009). Technologies for Processing Body-Conducted Speech Detected with Non-Audible Murmur Microphone. *10th Annual Conference of the International Speech Communication Association*, 632-635. Brighthon, UK. doi:10.1.1.158.763
- Torres - García, A. A., Reyes - García, C. A. & Villaseñor - Pineda, L. (2012). Toward a silent speech interface based on unspoken speech. In *Proceedings of the International Conference on Bio-inspired Systems and Signal Processing*, 370-373. Portugal. Retrieved October 6, 2014, from <http://ccc.inaoep.mx/~villasen/articulos/SilentSpeechInterfaceBasedOnUnspokenSpeech-BIOSTEC12.pdf>
- Verma, A., Cabrera, S., Mayorga, A. & Nazeran, H. (2013). A robust algorithm for derivation of heart rate variability spectra from ECG and PPG signals. In IEEE (Ed.), *2013 29th Southern Biomedical*

*Engineering Conference (SBEC)*, 35-36. Miami, Florida. doi:10.1109/SBEC.2013.26

Xinyi, G., Gengyin, L., Ming, Z. & K.I., L. (2011). Wavelet transform based approach to harmonic analysis.

*2011 11th International Conference on Electrical Power Quality and Utilisation (EPQU)*. Lisbon.

doi:10.1109/EPQU.2011.6128954



## Proposed methodology for assignment of spectral bands in wireless cognitive radio networks

### Propuesta metodológica para la asignación de bandas espectrales en redes inalámbricas de radio cognitiva

Danilo Alfonso López Sarmiento\*, Edwin Rivas Trujillo\*\*,  
Oscar Eduardo Gualdron Guerrero\*\*\*

**Fecha de recepción:** June 10th, 2014

**Fecha de aceptación:** November 4th, 2014

**Citation / Para citar este artículo:** López Sarmiento, D. A., Rivas Trujillo, E., & Gualdron Guerrero, O. E. (2014). Proposed methodology for assignment of spectral bands in wireless cognitive radio networks. *Revista Tecnura*, 18 (Edición especial doctorado), 61–69. doi: 10.14483/udistrital.jour.tecnura.2014.DSE1.a05

#### ABSTRACT

This paper raises a proposal starting from the current state that improves the process of allocation of spectral bands at the decision-making stage in cognitive radio, decreasing the time that the system takes to select a channel to transmit data from unlicensed users, assuming the existence of free spectrum and estimating the behavior of the secondary user and primary user.

**Keywords:** Cognitive radio networks, licensed and non-licensed users, proposal within conceptual diagram framework, spectral decision-making.

#### RESUMEN

El artículo plantea una propuesta enmarcada desde el estado actual, que mejore el proceso de asignación de bandas espectrales en la etapa de toma de decisiones en radio cognitiva, disminuyendo el tiempo que le toma al sistema la selección de un canal para transmitir datos de usuarios no licenciados, suponiendo la existencia de espectro libre y estimando el comportamiento de los usuarios primarios y usuarios secundarios.

**Palabras clave:** propuesta enmarcada en diagrama conceptual, usuarios licenciados y no licenciados, redes de radio cognitiva, toma de decisiones espectrales.

\* Full Time Professor at Universidad Distrital Francisco José de Caldas, Bogotá (Colombia). E-mail: dalopez@udistrital.edu.co

\*\* Full Time Professor at Universidad Distrital Francisco José de Caldas, Bogotá, Colombia. E-mail: erivas@udistrital.edu.co

\*\*\* Electronic Engineer, Full Time Professor at Universidad de Pamplona (Colombia). E-mail: oscar.gualdron@unipamplona.edu.co

## INTRODUCTION

Multiple studies show that one of the main problems with the inclusion of new applications in cognitive radio transport structure is associated with the inefficient distribution of available spectrum by governmental agencies (Shulka, 2013). That is, there are some currently licensed regions where radio space is underutilized (VHF / UHF bands) (FCC, 2010; Taher, Bachus, Adnek & Roberson, 2011) and other spectral regions (cellular bands) where a degradation in service quality has occurred. Researchers like Mitola (Mitola & Maguire, Cognitive radio: making software radios more personal, 2002) and Akyildiz (Akyildiz, Lee, Vuran, & Mohanty, 2008) have concluded that dynamic spectrum access (DSA) is a good strategy to address the issue of electromagnetic band administration. In Mitola, Software radios - survey, critical evaluation and future directions (1999), the possibility that administration of electromagnetic bands can be performed dynamically via Cognitive Radio (CR) is raised.

Therefore, this article is intended to generate an initial proposal (as a conceptual diagram) and supported from the current state, that solves the problem of spectral band assignment (Masonta, Mzyece, & Ntlatlapa, 2013) at the decision-making stage in cognitive radio (CR), since it is one of the issues that has been dealt with less in the CR paradigm.

## CONTEXTUALIZATION AND RELEVANT ASPECTS OF THE CURRENT STATE IN CR

In Mitola & Maguire, Cognitive radio: making software radios more personal (2002), Mitola argues that a network based on CR is defined as a complex structure in which devices are able to adapt to the environment. Within the characteristics of adaptability, is the capacity to use the spectrum in an opportunistic way, using their intelligence

and autonomy. In general, a CR should be able to perform four tasks efficiently: sensing, decision-making, sharing and spectrum mobility (figure 1).

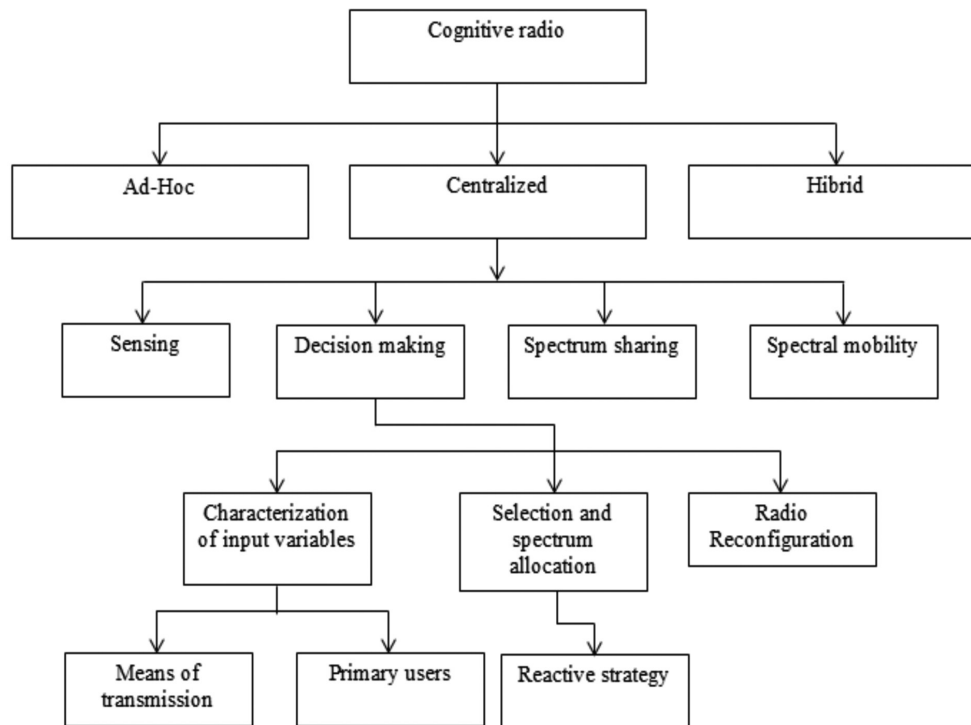
Sensing, sweeps the frequencies in the area of interest to identify the blank spaces most likely to be used in a given space of time, frequency, and power within a specific geographic region.

The decision identifies with the selection of the channel or group of channels in accordance with two factors: 1) the features available in the environment; 2) the needs requested by the SU to transport data (Akyildiz, Lee, Vuran, & Mohanty, 2008).

Sharing means properly managing the frequency bands to maximize their use without disrupting the PU and other CR users (Mitola & Maguire, Cognitive radio: making software radios more personal, 2002), (Akyildiz, Lee, Vuran, & Mohanty, 2008).

Mobility is the ability of CR to leave a portion of the frequency spectrum occupied when a PU starts using it, and also search for another suitable empty space for communication (Mitola & Maguire, Cognitive radio: making software radios more personal, 2002). The CR devices should therefore have the ability to detect, recognize and adapt to the specific features offered by the environment.

One of the most important properties of cognitive radio networks (CRNs) is the ability to dynamically access the spectrum. However, users of cognitive radio (CRU) may also be able to recognize patterns of occupation (Bolívar, 2012), to reduce energy used in detection, signaling and transmission. Therefore, CR is also considered as an alternative capable of reducing power consumption in radio communications and has also been selected as a solution to the so-called shortage of wireless spectrum (Mitola & Maguire, Cognitive radio: making software radios more personal, 2002), (Goldsmith, Jafar, Maric, & Srinivasa, 2009). Studying the spectral decision stage involves previously defining the physical topology of the network to be worked, which can be distributed (Ad-Hoc), centralized (infrastructure-based) or hybrid (Figure 1).



**Figure 1.** Contextualization of cognitive radio and decision making

**Source:** The authors.

In an infrastructure-based system, all users within the area of operation manage their decision requests through a central device, as in specification (IEEE 802.22, 2012), (Wireless Regional Area Network-WRAN), (Wang, Ghosh & Challapali, 2011).

Since the cognitive radio network (CRN) operates within the licensed users' coverage region, it uses DSA techniques to opportunistically access the primary network spectrum without causing harmful interference to the licensed users, as is also the case of Ad-Hoc. To this end, the SUs observe the spectrum in the specified bands, then send them to the base station (BS) which acts as a broadcasting center (Kolar et al., 2009).

Both the BS and its associated clients can detect the presence of the PUs using detection techniques such as that based on energy, or cycle seasonality among others. In some cases, as in (Akyildiz, Lo & Balakrishnan, 2011) two physical media are used, one to observe the behavior of the primary channel and the other to constantly update the BS.

Once the information is analyzed and there is clarity regarding available channels, the BS will build the definitive list of bands together with the quality of service (QoS) available in each case, so that they can be exploited opportunistically by the SUs. Once the prior stage of sensing has been defined, characterization, channel selection and radio reconfiguration are the elements that make up the spectral decision (Figure 1).

## Characterization

Since there is no guarantee as to what spectral band is available during the transmission of a SU, it is important to consider how often PUs appear. Using the learning ability of the CR, the use of spectrum history is utilized to predict the future profile of the spectrum (Akyildiz, Lee, Vuran, & Mohanty, 2008), modeling the activity of PUs and SUs seeking to avoid generation of collisions. The concept of characterization within the spectrum



decision has been addressed in many articles from the perspective of channel conditions (evaluating and proposing new strategies to identify and improve aspects related to channel coding, modulation, bandwidth, etc.) and is not addressed here because within the proposed methodology this variable is assumed to be known.

In the characterization of the primary (Vishram, Lau, Syin, & Ashish, Energy aware spectrum decision framework for cognitive radio networks, Electronic System Design (ISED), 2012) it concludes that a significant number of existing approaches have a very high computational cost, making their implementation virtually impossible for nodes whose life is based on battery usage (in rural areas); this is why in spite of being one of the most discussed topics by researchers, it remains a developing research line.

Perhaps one of the critical and less demanding aspects is related to the secondary, where most papers that address the issue, reduce its study to a medium access control problem, relegating in most cases to a backseat the importance that the study of SUs frequency of occurrence could have on the licensed band, on improving the decision-making stages, sharing, and spectral mobility.

#### *Estimated behavior of the PU*

Some of the proposals on this topic are in Derakhshani & Le-Ngoc (2012), where PU characterization assumes that there is no synchronization with the SU, causing their dynamic type behavior. Their behavior is simulated as a two state ON/OFF continuous random process to reproduce the PU occupancy periods. As a design and operation criteria of SUs it determines that once the band  $i$  is detected as inactive during the sensing stage, the chance that it will be busy  $t$  seconds later is denoted by  $\pi_{01}^i(t)$ , and that the probability that the PU will once again fill the  $i$  spectrum since in principle it has been sensed as idle at the beginning of this time interval, is defined as the instant mean (equation (1)) that the PU could make a transmission.

$$\alpha_i = \frac{1}{T - \tau} \int_0^{T-\tau} \pi_{01}^i(t) dt \quad (1)$$

While  $\alpha_i$  is independent of time, it can be considered as a statistical function of spectrum use, and given its value there will be a greater or lesser probability of collision; therefore, to ensure quality transmission for the PU  $\alpha_i$  must be of a value smaller than a set level.

Brah, Dayoub, & Vandendorpe (2012) consider a main network having  $j$  valid primary users for  $j = 1 \dots J$  and a bandwidth of  $B$  Hz, where its value is divided into  $N$  orthogonal narrowband subcarriers for  $n = 1, \dots, N$ , with each range of frequency  $B_S = B/N$  small enough to ensure that the channel fading is flat. The PU occupies the channel following an ON/OFF type structure, where the ON period represents the interval during which the primary actively uses its channel in a  $T_c$  time. Based on this premise, it is assumed that the PU remains active (ON state) with an  $\alpha$  probability, or inactive (OFF state) with probability  $\delta = 1 - \alpha$  in a  $T_c$  time period. In the distribution of the underlying spectrum, it is allowed access to the secondary if the impact on its output does not substantially degrade the quality of the signal received from the PUs; this parameter is assessed with the restricted probability of collision in terms of equation (2).

$$\Pr\{I_{j,n} \geq Q_{j,n}\} \leq \eta_{j,n} \quad (2)$$

Where  $I_{j,n}$  is the level of interference imposed by transmission from the secondary to the primary  $j$  in sub-carrier  $Q_{j,n}$ ; is the maximum level of interference, and  $\eta_{j,n}$  is the maximum tolerable collision probability. In fact, the primary user  $j$  will experience a collision in sub-carrier  $n$ , if  $I_{j,n} > Q_{j,n}$ .

Channel holding time (CHT) corresponds to the mean average expected period that the PUs may occupy a free slot before being interrupted; the greater the CHT, the better the quality of service (QoS) for the SUs (802.22, 2013), (Masonta, Mzyece, & Ntlatlapa, 2013). The CHT can be

determined by the type of secondary services supplied by the CRN or the service provider.

Canberk, B., Akyildiz, & Oktug (2010) exhibit a Markov model to establish the duration of spectrum slot usage. This model is based on the concept of CHT for the PU. Once the downtime is modeled (TTC), matrix analytical techniques can analyze and determine the duration of the spaces available to be accessed by the SUs; however, one of the main drawbacks of this technique is its complexity (Masonta, Mzyece, & Ntlatlapa, 2013). In Daoud, Alanyali, & Starobinski (2007), the concept of time-spectrum block (representing the length of time the SU occupies a portion of vacant spectrum without causing interference to the PUs) was introduced, and established how to calculate it to reduce the probability of network collisions (Masonta, Mzyece, & Ntlatlapa, 2013).

A statistical approach based on binary time series discloses the deterministic and non-deterministic behavior of channel use and predicts future occupancy of the PU (Yarkan & Arslan, 2007). The complexity of analysis and the amount of storing data memory reduces it assuming a sequence of binary states, thus simplifying the spectrum occupancy ("1" is empty, "0" is used). Of tests conducted, the short range prediction factor is quite satisfactory for the first two tests; however, in the third sample, prediction success severely degrades because the model is not updated, and because of the non-deterministic data behavior; this problem could theoretically be solved by increasing its order at the expense of an exponential increase of parameters to generate the prediction. From a deterministic perspective, the estimate is quite robust for the first four time slots as tested for three different bands in a GSM network, while capturing with a duration of 17 ms of which 30 observations per channel were obtained after applying the prediction model in the binary time series. Authors do not record any computational cost analysis inherent in the use of time series and this should be a study variable to validate the methodology because it is usually a limiting factor due to the high

computational cost that it entails, in addition to a high collision probability (Masonta, Mzyece & Ntlatlapa, 2013).

#### *Estimated behavior of SUs*

Most of the available proposals that involve decision-making focus their work on monitoring the PUs ignoring the modeling of SUs (Masonta, Mzyece, & Ntlatlapa, 2013); it is an important parameter for optimal network functioning because it has a direct impact on the presence or absence of collisions, and their adequate representation will result in a better use of the channel when it is available and there is a significant number of SUs. Within the few existing contributions in mainstream journals there is (Derakhshani & Le-Ngoc, 2012), where a proposal that includes a qualitative and quantitative analysis to improve the use of free bands using opportunistic spectrum access methodologies is shown.

#### *Channel selection*

After characterizing the users, the next step is to select and assign the best available spectrum (depending on the network used, which in our case will be centralized (Figure 1) to be assigned in accordance with the requirements requested by the SUs (Masonta, Mzyece, & Ntlatlapa, 2013), using a reactive or proactive strategy. Two of the existing state of the art approaches are:

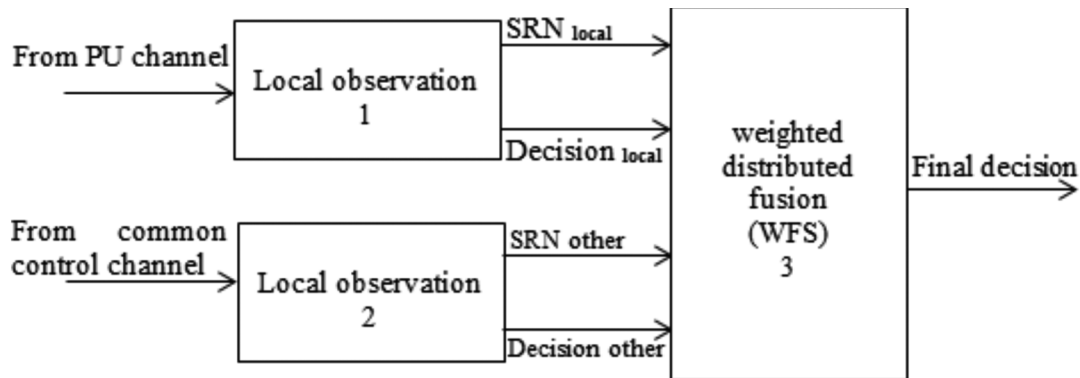
(Barnes, Maharaj, Prediction based channel allocation performance for cognitive radios, 2014) (Vishram, Lau, Syin, & Ashish, Energy aware spectrum decision framework for cognitive radio networks, 2012) In which the problem to be solved is the ever increasing number of mobile nodes in CRNs, and therefore of communications in the electromagnetic spectrum, with the ensuing shortage of available channels. From this perspective, the algorithm to optimize the allocation of transmission channels for PUs and SUs becomes necessary, supported by availability and performance. Proposers use the of Markov hidden model techniques (HMM), which operate in a sequence of

binary states to detect when PUs and SUs coexist serially.

The solution consists on a channel switching simulator for a SU (with centralized infrastructure) and for testing purposes it has a physical layer component that includes modulation, error correction rate, bandwidth, period between frames and maximum number of future frames. It was observed that under heavy traffic conditions, the measurement was consistent with the theoretical calculation, at increasing L values (length of observation) and more precisely at L = 400 and with a number of frequencies equal to 20 ( $\mathcal{F} = 20$ ) the yield doubled, halving PU interruptions and thus minimizing the number of SU switching operations probably due to limited availability. In light traffic conditions and for the same L and  $\mathcal{F}$  values, performance fell significantly and PU interruptions

more than doubled since with more availability, the number of SU switching operations increased.

A decision system in the dynamic and cooperative spectrum is made available to the academic community to determine the appropriate channel, using the paradigm of weighted fusion distributed (WFS) that combines individual decisions to determine the appropriate one using cooperation. It is compared to conventional fusion mechanisms such as the AND, OR type rules and GREATER THAN criteria, comparing the results in variables such as false alarm percentage and high detection probability. Network architecture is based on centralized topology for primary users and distributed for cognitive nodes. The block diagram arrived at and implemented in each SU that monitors the radio space and collects signal-to-noise indicators is shown in Figure 2 (Berk & Sema, 2012).



**Figure 2.** Allocation of frequency bands

**Source:** Berk & Sema (2012).

In this diagram, the user creates a decision on spectrum (existence or not of PUs); then each node broadcasts this local information to the network through the common control channel (CCC) of the signal to noise tracking system. Once transmitted, received and processed, each node runs the WFS and thus obtains a cooperative decision. Specifically, sub-block 1 is responsible for monitoring enabled channels, and collecting local observation of the CRN.

In 2, a subroutine is shown for transmission of messages handled by all distributed network users

to communicate with other nodes. Each SU generates its own messages  $M_{(i, j)}$ , and transmits them through module 2 using the equation (3).

$$M_{i,j} = (D_{i,j}SNR_{i,j}) \quad (3)$$

Where  $D_{i,j}$  represents the local decision, and  $SNR_{i,j}$  observation of the local signal to noise ratio (SNR) made by the user in the  $i$ th channel. Additionally sub-block 2, gathers and forwards all  $SNR_{i,j}$  observations made and  $D_{i,j}$  decisions made by other users to the WFS module. In 3 (Figure

2), all information generated is received and the cooperative decision is calculated using equation (4).

$$w_{i,j} = \frac{SNR_{i,j}}{\sum_{i=1}^n SNR_{i,j} \cdot \text{ad hoc\_effect}_i} \quad (4)$$

Where  $SNR_{i,j}$  is the observation in DB of the  $i$ th network user in the  $j$ th channel, the total number of users,  $\text{ad hoc\_effect}_i$  is a coefficient of the  $i$ th user of the localized network in relation to the corresponding user in the ad-hoc network topology.

## DISCUSSION

From scientific literature consulted, it has been observed that research has focused on spectrum sensing and mobility; at the decision-making stage in most cases they only propose qualitative solutions, lacking quantitative solutions. In this same vein, studies have focused on characterization of the most important source which is the PU, relegating the SU; variable that should be taken into account because it will lead to a better channel use and distribution. In the context of spectrum selection, the vast majority of authors such as Haykin, Akyildyz, Vishram, Wu, have shifted their models towards reactive strategies (transmission band selection after user requests service) with a major drawback, due to time (crucial variable within the context of telecommunications), which is spent searching and selecting the free frequency for the SU. The implementation of proactive strategies (where selection is decided seconds before arrival of the cognitive user) based on intelligent models such as machine language (machine learning), and support vector machines, will allow the reduction of band allocation time improving the spectral decision stage.

## CONCEPTUAL DIAGRAM OF THE PROPOSAL

From the approach described above, we intend to design and build a predictive spectral selection

model for cognitive users starting from characterization of heterogeneous users within a centralized network topology for the IEEE 802.22 band. The model will be designed and built during the development of a doctoral research work developed by the main author of the article; and for that the conceptual model of figure 3 is proposed as a basis.

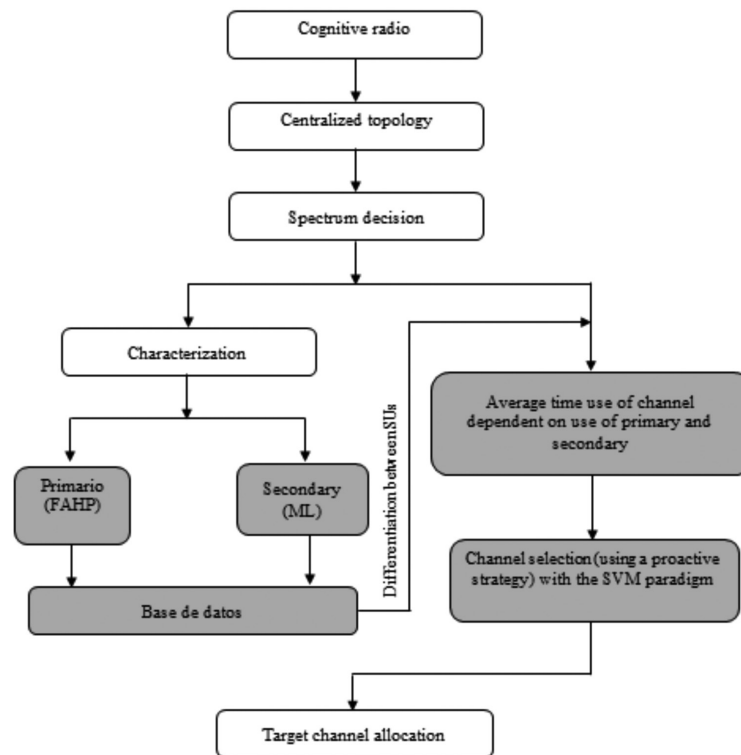
The subfields in which it is expected to generate input are marked in dark, and the overall operation description of the proposed methodology is as follows:

Before the process of characterization, the existence of a range of free channels to be used by SUs (sensing) is assumed.

To characterize the PU we estimate taking an existing model and improving it using the FAHP (Fuzzy Analytical Hierarchy Process) technique, which has a low computational cost and the ability to handle multiple variables without increasing its complexity.

Characterization of the SUs (the number of nodes that attempt to access the CRN will be increased over time), will be performed using the artificial intelligence Machine Learning (ML) concept or starting from layer 2 of the OSI reference model. The characterization process is intended to be carried out by each cognitive node and sent to a database located in the Base Station (BS) with the mission of storing and labelling the information, differentiating it from the information sent by the multiple SUs (through the use of labels) and PU.

This will allow the base station to clearly distinguish the SUs from the PU and the SUs from each other. This historical data will in turn be used by the channel selector algorithm (by implementing a proactive strategy) to assign channels according to the SU requirements (provided there are resources) using the Support Vector Machine paradigm (SVM). Thus the aim is to reduce channel selection time increasing CR performance.



**Figure 3.** Location of the Doctoral proposal within the context of the CR

**Source:** The authors.

## CONCLUSIONS

The authors of this article pose a conceptual diagram (figure 3) in order to develop a predictive channel selection system in accordance with the quality of service requirements, taking into account not only the behavior of primary users, but also involving the secondary, which will allow a more equitable use and better optimization of the media, by the cognitive nodes that make up the CR network.

Several new aspects that have not been addressed so far are included in the proposal, highlighting the inclusion of a database at the decision-making stage, as support for storing user behavior history as well as their use of channels, information that may be relevant not only at the decision making stage, but also at mobility stage (by applying spectral handoff) to generate more accurate predictive models.

Another important component is included as an active variable within the operation of SUs system which will allow reducing the risk of collision between them (when the number of cognitive nodes that access the network increases) and between the SUs-PU; making it possible to generate along with the database, a more suitable and equitable spectral selection model for all cognitive nodes.

## REFERENCES

- 802.22, I. S. (2013). *Working Group on Wireless Regional Area Networks*. IEEE.
- Akyildiz, I. F., Lee, L. W.-Y., Vuran, M. C. & Mohanty, S. A. (2008). A survey on spectrum management in cognitive radio networks. *IEEE Communications Magazine*, 40-48.
- Akyildiz, I., Lo, B. & Balakrishnan, R. (2011). Cooperative spectrum sensing in cognitive radio networks: a survey. *Elsevier, Physical Communications*, 40-62.



- Barnes, S., Maharaj, B. (2014). Prediction based channel allocation performance for cognitive radios, *International Journal of Electronics and Communications*, Elsevier, 68(4), 336-345.
- Berk, C. & Sema, O. (2012). A dynamic and weighted spectrum decision mechanism based on SNR Tracking in CRAHNS. *El Sevier, Ad Hoc Networks*, 752-759.
- Bolívar, N. (2012, June). Tesis Doctoral: Medium access control messaging scheme for cognitive radio networks. *Departamento de computación, arquitectura y tecnología*. España: Universidad de Girona.
- Brah, F., Dayoub, I. & Vandendorpe, L. (2012). Constrained resource allocation for OFDMA cognitive radio networks with primary users activity consideration. *IEEE International Symposium on Wireless Communications Systems (ISWCS)*, 766-770. Paris: IEEE.
- Canberk, B. B., Akyildiz, I. & Oktug, S. (2010). A QoS-aware framework for available spectrum characterization and decision in cognitive radio networks. *21st Annual IEEE International Symposium on Personal, Indoor and Mobile Radio Communications*, 1533-1538. IEEE.
- Daoud, A., Alanyali, M. & Starobinski, D. (2007). Secondary pricing of spectrum in cellular CDMA networks. *IEEE Int. Symposium for New Frontiers in DySPAN*, 535-542. Dublin: IEEE.
- Derakhshani, M. & Le-Ngoc, M. T. (2012). Learning-Based opportunistic spectrum access with adaptive hopping transmission strategy. *IEEE Transactions on Wireless Communications*, 3957-3967.
- FCC. (2010). *Spectrum policy task force*. ET Docket.
- Goldsmith, A., Jafar, S. A., Maric, I. & Srinivasa, S. (2009). Breaking spectrum gridlock with cognitive radios: An information theoretic perspective. *Proceedings of the IEEE*, 894-914.
- IEEE 802.22. (2012, March 7). *Enabling Spectrum Sharing and Rural Broadband Wireless Access Using Cognitive Radio Technology in White Spaces*. Retrieved from IEEE 802.22, Working Group on Wireless Regional Area Networks: <http://www.ieee8.org/22/>.
- Kolar, V. et al. (2009). Capacity estimation and adaptation in cognitive radio networks: Demonstrating software defined radios in action. *International Conference on Mobile Computing and Networking (MobiCom)*, 20-25. Beijing: MobiCom.
- Masonta, M., Mzyece, M. & Ntlatlapa, N. (2013). Spectrum decision in cognitive radio networks: A Survey. *IEEE Communications Surveys & Tutorials*, 1088-1107.
- Mitola, J. (1999). Software radios - survey, critical evaluation and future directions. *Proceedings of the National Telesystems Conference (NTC 1992)*, 24-36. Washington: IEEE.
- Mitola, J. & Maguire, Q. (2002). Cognitive radio: making software radios more personal. *IEEE Personal Communications*, 13-18.
- Shulka, A. (2013, June 10). *Cognitive radio technology*. Retrieved from A study for OFCOM: [http://enstakeholders.ofcom.org.uk/binaries/research/technologyresearch/cograd\\_main.pdf](http://enstakeholders.ofcom.org.uk/binaries/research/technologyresearch/cograd_main.pdf)
- Taher, T. M., Bachus, R. B., Zdunek, K. J. & Roberson, D. A. (2011). Long-term spectral occupancy findings in Chicago. *IEEE Symposium on New Frontiers in Dynamic Spectrum Access Networks (DySPAN)*, 100-107. Germany: IEEE.
- Vishram, M., Lau, C., Syin, C. & Ashish, K. (2012). Energy aware spectrum decision framework for cognitive radio networks, Electronic System Design (ISED). *International Symposium on IEEE*, 309-313. Kolkata: IEEE.
- Wang, J., Ghosh, J. M. & Challapali, K. (2011). Emerging cognitive radio applications: A survey. *IEEE Communications Magazine*, 74-81.
- Yarkan, S. & Arslan, H. (2007). Binary time series approach to spectrum prediction for cognitive radio. *IEEE Vehicular Technology Conference*, 1563-1567. Baltimore: IEEE.

## Authenticated encryption of pmu data

### Criptoautenticación de datos en una PMU

Elvis Eduardo Gaona García\*, Sergio Leonardo Rojas Martínez\*\*,  
Cesar Leonardo Trujillo Rodríguez\*\*\*, Eduardo Alirio Mojica Nava\*\*\*\*

**Fecha de recepción:** June 10th, 2014

**Fecha de aceptación:** November 4th, 2014

**Citation / Para citar este artículo:** Gaona García, E. E., Rojas Martínez, S. L., Trujillo Rodríguez, C. L., & Mojica Nava, E. A. (2014). Authenticated encryption of PMU data. *Revista Tecnura*, 18 (Edición especial doctorado), 70–79. doi: 10.14483/udistrital.jour.tecnura.2014.DSE1.a06

#### ABSTRACT

This paper presents the implementation of an encryption board in order to provide confidentiality, authenticity and integrity of data collected at any point in a power grid, as a potential solution to the Smart Grid cyber security issues. This board consists of a Freescale microcontroller which enables the connection between a PMU (Phasor Measurement Unit) and a ZigBee transmitter. Encryption is done using the SHA256, HMAC-SHA256, KDF-SHA256 and AES256-CBC algorithms. This architecture makes reading and transmission of voltage and current phasors, energy consumption, frequency, power, power factor and power outages measurements, and sends this information in real time to a data concentrator where display and subsequent storage are possible.

**Keywords:** cyber security, hash function, phasor measurement, smart grids, symmetric cryptography unit.

#### RESUMEN

Este artículo muestra la implementación de una tarjeta de encriptado con el fin de proporcionar confidencialidad, autenticidad e integridad de los datos recolectados en cualquier punto de una red eléctrica, como posible solución a las dificultades que presenta el cibersecurity en las Smart Grid. Esta tarjeta está compuesta por un microcontrolador Freescale que permite la conexión con una PMU (Phasor Meter Unit) y dispositivos ZigBee. La encriptación se realiza empleando los algoritmos SHA256, HMAC-SHA256, KDF-SHA256 y AES256-CBC. Esta arquitectura realiza lectura y transmisión de mediciones de los fasores de voltaje y corriente, consumo de energía, frecuencia, potencias, factor de potencia e interrupciones de energía y los envía a un concentrador de datos en tiempo real, donde es posible su visualización y posterior almacenamiento.

**Palabras clave:** ciberseguridad, criptografía simétrica, función hash, redes inteligentes unidad de medición fasorial.

\* He is a Ph.D. student in Engineering at Distrital University, Bogotá D.C. Colombia. He earned a M.Sc. in Information Science and communications at Distrital University, Colombia. He is professor at Engineering Faculty of Distrital University. His research interests are network and communications, microgrids. Contact: HYPERLINK "mailto:egaona@udistrital.edu.co" egaona@udistrital.edu.co

\*\* He earned Electronic Engineer at the Distrital University. Contact: HYPERLINK "mailto:slrojasm@correo.udistrital.edu.co" slrojasm@correo.udistrital.edu.co

\*\*\* He earned a Ph.D. in Electronic Engineering at Polytechnic University of Valencia in Madrid, Spain. He earned a M.Sc. in Electrical Engineering at Distrital University, Colombia. He is professor at Engineering Faculty Distrital University. His current research interests include Electrical Power, Microgrids. Contact: HYPERLINK "mailto:cltrujillo@udistrital.edu.co" cltrujillo@udistrital.edu.co

\*\*\*\* He earned a Ph.D. in Automation and Industrial Informatics at École des Mines de Nantes in France, Nantes. He earned a M.Sc. in Electrical Engineering and Computer at Andes University, Colombia. He is associate professor at the Department of Electrical and Electronics Engineering, National University of Colombia, Bogotá. His current research interests include Distributed Control Systems, Smart Grid. Contact: HYPERLINK "mailto:eamojican@unal.edu.co" eamojican@unal.edu.co

## INTRODUCTION

Reliability and security of data collected by electric meters on the consumer side and the utilization of these data for pricing and consumption profiles require solutions for data transmission between the meter and the energy providers protecting customer privacy and ensuring accurate readings without modification of others.

For this purpose, it is necessary to establish a security system fulfilling integrity, authenticity and confidentiality requirements in order to prevent data alteration and unauthorized access to the network. Breaching channel confidentiality allows inferring consumption information revealing personal habits such as if someone was in a place for a particular time. Likewise, measuring and pricing process requires a secure transmission procedure where data integrity and authenticity are certified, since validity of user pricing method and power grid state estimation depend on it (NIST, 2010). Authors like DAI & YAN (2010), Peng, Elkeelany, & Layton, (2010), Seshabhatar, Priyanka, Krier, & Engels (2011), Gangil & Rakesh (2013) and Stallings (2011) present solutions including symmetric algorithms and HASH functions as a proposal to the Smart Grid security issues, fulfilling information confidentiality, authenticity and integrity purposes.

De Craemer & Deconinck (2010), Fan, *et al.* (2012), Luan, Teng, Chan, & Hwang (2009) and Khalifa, Naik, & Nayak (2011) have postulated the Zigbee protocol as a potential solution to obtain simultaneous measurements in real time from multiple connected devices similarly to AMR (Automatic Meter Reading) networks; this, given the smooth implementation of short-range networks with low energy consumption and data transfer rates up to 250 Kbits/s.

This paper shows a possible solution to the Smart Grid cyber security issues by means the implementation of an encryption board which

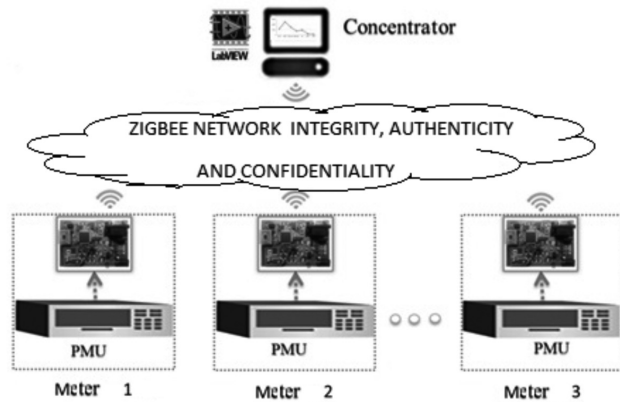
provides confidentiality, authenticity and integrity of data collected anywhere on the power grid. The paper is organized as follows: section 2 describes the methodology used for the design and implementation of the encryption board and its role within the reading system, as well as the transmission of data measured by a PMU. In section 3 the obtained simulation results, the designed HMI interface and the implementation of the encryption board are presented. Finally, in section 4 conclusions are shown.

## METHODOLOGY

### Proposed Architecture

Figure 1 shows the proposed architecture for reading, transmission and storage of information related to the power grid state and energy consumption in different points; the proposed system is divided in two parts, the data concentrator and the meter; in this case, the meter is composed by a PMU and an encryption board. The PMU performs the measurements related to the power grid variables, and the encryption board captures the information from the PMU converting it into confidential information, performing the integration and authentication by means of a security scheme; wireless transmission is made using a Zigbee network with star topology where the concentrator has the role of network coordinator and each of the meters is an end device.

On the meter side the PMU 1133A Power Sentinel of company ARBITER SYSTEMS is used, which collects the voltage and current phasor, energy consumption, frequency, power, power factor and power outages measurements. The measured values are stored in internal registers, and the MODBUS RTU protocol is used via an RS232 serial connection to route them externally.



**Figure 1.** Measurement system architecture

**Source:** Own work.

The encryption board is composed by a Free-scale microcontroller of ColdFire V1 family, which allows the connection to the PMU and the ZigBee transmitter through two asynchronous serial modules and the connection to the ATSHA204 cryptographic keys storage device through the I2C (Inter-Integrated Circuit) synchronous serial module. The microcontroller software contains subroutines to implement the MODBUS-RTU protocol, from the SHA256 (NIST, 2012), HMAC-SHA256 (NIST, 2008), KDF-SHA256 (NIST, 2011) and AES256-CBC (Daernen & Rijnen, 2002), (NIST, 2001) algorithms used in four main processes: i) Reading and transmission of PMU information, ii) data encryption, addition of authenticity and integrity to the information, iii) verification of information authenticity and integrity and iv) key derivation.

The concentrator consists of a ZigBee communication module, a user interface designed in Labview, and the software including subroutines for the SHA256, HMAC-SHA256, KDF-SHA256 and AES256-CBC algorithms used for the meters administration, data validation and information display and storage.

## Security Scheme

In the implementation of the security scheme the recommendations of the National Institute of Standards and Technologies (NIST) and Cyber Security (CS) in Smart Grid (SG) (NIST, 2010) were taken into account, approving the use of existing cryptographic functions and algorithms, as well as configurations and parameters to get a better performance and an adequate security level. There are three families of cryptographic algorithms—HASH functions, symmetric algorithms and asymmetric algorithms; for the three families NIST approves only the use of the algorithms listed in Easter & Bryson (2012).

Each algorithm can be used for a specific purpose or to fulfill several objectives in the same process. Table 1 shows the algorithms used to provide confidentiality, integrity or authenticity to a communication channel; at the same time, they can be used to generate cryptographic keys (KDF Key Derivation Function) or distribute them (KD - Key Distribution) and in the process of random number generation (RNG - Random Number Generator).

**Table 1.** Functions available for each of the families of cryptographic algorithms

Function	Symmetric	Asymmetric	HASH
Confidentiality	YES	YES	-
Integrity	YES	-	YES
Authenticity	YES	YES	YES
KDF	-	-	YES
RNG	-	YES	YES
KD	YES	YES	-

**Source:** (NIST, 2007).

The security scheme proposed in this paper addresses the need to protect the data confidentiality, integrity and authenticity by means of symmetric



cryptographic algorithms, since the keys for these algorithms are smaller than those of an asymmetric algorithm with the purpose of obtaining the same level of security requiring less time to process information. In addition, less resources in a communication channel are required, since the encrypted text has the same size than the plaintext, ensuring that all the sent information will be useful, which does not occur with asymmetric algorithms, which add bits to the encrypted text increasing the size with the same useful information (Khurana et al., 2010).

The implemented security system is divided in two parts: i) the process of key generation and distribution, where only the SHA256 algorithm is used and ii) the authenticated encryption scheme where the HMAC-SHA256 algorithm is used to calculate the MAC (Message Authentication Code) and therefore to determine the information integrity and user authenticity, and the AES256 algorithm to protect the information confidentiality.

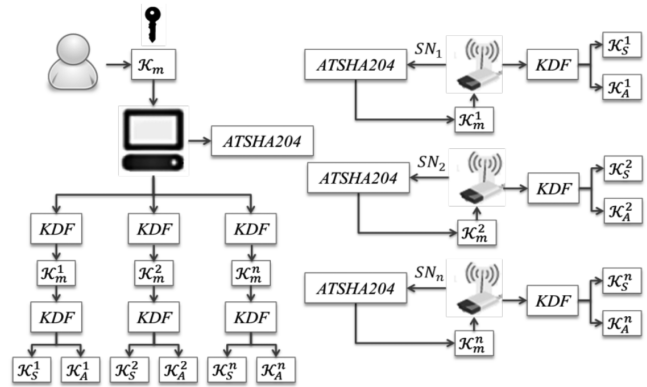
**Key generation and distribution scheme**

The proposed security system fulfills the following requirements:

- It does not compromise the security of any objective (authenticity, integrity and confidentiality) when one in particular is compromised.
- It does not compromise the security of any node when the security of one in particular is compromised.

To fulfill the first requirement, independent keys are used for each of the objectives; the keys used in the security system are listed below:

- Symmetric key for authentication  $k_A$ : Key used in the HMAC algorithm to generate the HASH code that allows obtaining the message authentication code.
- Symmetric key for information encryption  $k_S$ : Key used by AES-256 to protect the information confidentiality in the communication channel.
- Master symmetric key  $k_m$ : Key used by the KDF algorithm to derivate other keys ( $k_A, k_S$ ).



**Figure 2.** Key derivation and distribution scheme

**Source:** Own work.

To simultaneously fulfill both requirements, the scheme of figure 2 is implemented, where a different key set is used for each of the meters associated to the network. The initial master key  $k_m$  is introduced in the concentrator and in the key transportation device ATSHA204. In each of the meters a key set  $K_m^n, K_A^n$  and  $K_S^n$  is derived; in the first step  $K_m^n$  is derived by executing the equation (1) over the device ATSHA204, where  $MAESTRA$  is the indicator of the selected meter,  $SN$  is the serial of the ZigBee module,  $MAESTRA$  is the label indicating that the key is derived. In this case, with value 0x00 and KDF is defined by equation (2).

$$K_m^n = KDF(K_m, MAESTRA, 0x00, SN^n, 0xFF) \quad (1)$$

$$y = KDF(x) = SHA256(x); |x| < 2^{64} \text{ bits}; |y| = 256 \text{ bits} \quad (2)$$

To derivate  $K_A^n$  and  $K_S^n$ , equations (3) and (4) are executed over the microcontroller, where

$AUTENTICACION=0x01$  and  $ENCRIPACION=0x02$ .

$$K_A^n = KDF(K_m^n, AUTENTICACION, 0x00, SN^n, 0xFF) \quad (3)$$

$$K_S^n = KDF(K_m^n, ENCRIPACION, 0x00, SN^n, 0xFF) \quad (4)$$



Simultaneously, the same process is executed over the concentrator; in this way, the concentrator and each meter have the same key set.

**Authenticated Encryption Scheme**

The authenticated encryption scheme uses the AES-256 and HMAC-SHA256 algorithms together to fulfill confidentiality, integrity and authenticity objectives. The AES-256 algorithm is used in the CBC (Cipher- Block Chaining) configuration where each of the encrypted blocks depends on the previous blocks allowing encrypted text blocks are indistinguishable between them.

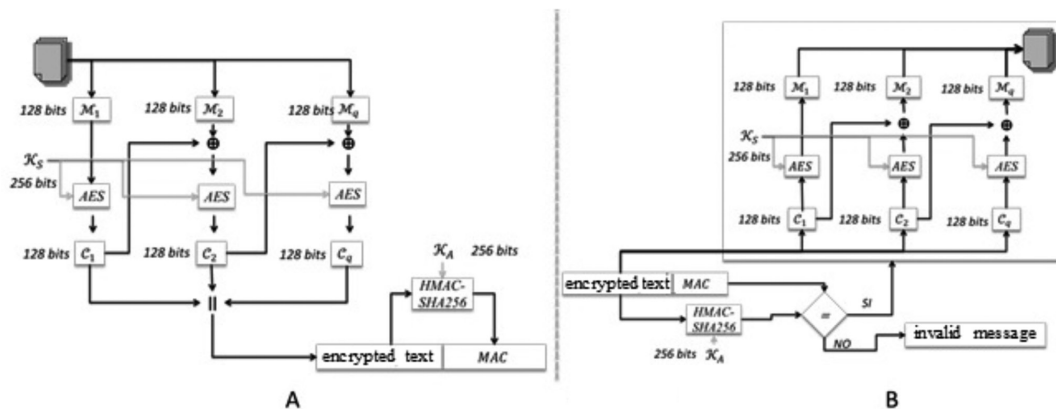
The HMAC-SHA256 algorithm is a variation of the SHA256 algorithm described by equation (5), which allows generating a message authentication code (MAC) from a HASH function, where *ipad* is

0x36 repeated 64 times and *opad* is 0x5c repeated 64 times.

$$HMAC = H((K_0 \oplus opad) || H((K_0 \oplus ipad) || M)) \quad (5)$$

From Katz & Lindell (2007), the EtM (Encrypt then MAC) configuration is used, which simultaneously utilizes both algorithms, first perform the encryption of the plaintext and then the MAC is computed protecting directly the encrypted text against integrity or authenticity attacks and indirectly the plaintext.

Figure 3 summarizes the process to perform in order to send the information protecting its confidentiality, integrity and authenticity, and Figure 4 shows the process to verify the integrity and authenticity and additionally decrypt the received information.



**Figure 3.** CryptoAuthentication Scheme for (A)information transmission and (B) information receiving and validation

Source: Own work.

*Network architecture based on Zigbee technology*  
Transmission is done through a Zigbee network with star topology, where each network device has an associated Zigbee module. In this case, the concentrator manages the network and communicates with each of the meters. For this reason, the Zigbee module is configured as coordinator, and meters have a module configured as end device.

Each time the information is sent from the coordinator to the meter or vice versa, the process

of Figure 3 is executed, and the information is encapsulated in the frame structure provided by the Zigbee API operating mode.

# Bytes	Serial	Datos	MAC
1 byte	8 Bytes	16*n Bytes	32 bytes

**Figure 4.** Payload structure of Zigbee API frame

Source: Own work

Figure 4 shows the distribution of the payload field of the API frame, the data field has a size multiple of 16 bytes given by the AES256 algorithm, always encrypted and which sends the frames of figures 6 and 7; the MAC field is the result of running the HMAC-SHA256 algorithm over the data field.

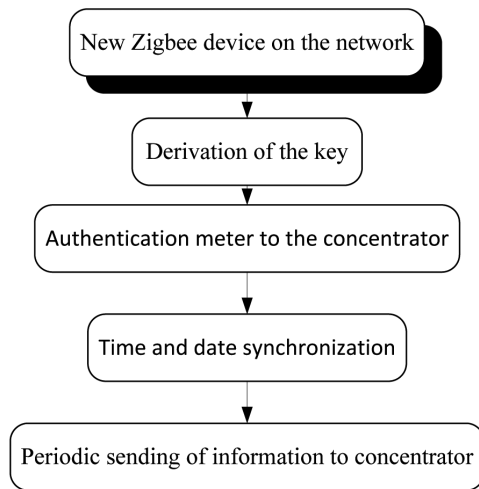


Figure 5. Flowchart for starting the encryption board and information transmission

Source: Own work.

Figure 5 shows the flowchart that a meter follows when the encryption board is started. In the first step the coordinator executes the admission process of a new Zigbee device on the network, then the derivation of the key set is done in the microcontroller and it proceeds to send the request for authorization of figure 6, where the result of calculate  $SHA256(\mathcal{K}_A^n || \mathcal{K}_S^n)$  is sent.

When the concentrator receives the request, it performs the same calculation with the keys derived inside and compares the result, checking the MAC it is verified that the keys generated by the two parties are the same without having to send them by the communication channel and simultaneously the identity of the meter sending the information is verified. Once keys and identity are confirmed, the confirmation of authorization of figure 7 including actual date and time is sent, the meter is authorized

and synchronizes date and time, with this the setup process finalizes and the periodic sending of information starts as requested by the concentrator.

Valor	0x00	-	-	-	-	-	-	-	-	-	-	0x00
Nombre	Comando	Fecha	V	Fase V	I	Fase I	P. Activa	P. Reactiva	P. Aparente	Factor de P.	Frec	Ceros
# Bytes	1	7	2	2	2	2	2	2	2	2	2	6

Valor	0x01	-	-	-	-	-	-	-	-	-	-	-
Nombre	Comando	Fecha	E. Activa	E. Aparente	E. reactiva C1	E. Reactiva2	E. reactiva C3	E. reactiva C4				
# Bytes	1	7	4	4	4	4	4	4				

Valor	0x02											0x00
Nombre	Comando											Ceros
# Bytes	1											15

Figure 6. Types of frames sent from the meter to the concentrator

Source: Own work.

Petición Iniciar Medicion Tiempo Real						
Valor	0x00					0x00
Nombre	Comando					Ceros
# Bytes	1					15

Petición Detener Medicion Tiempo Real						
Valor	0x01					0x00
Nombre	Comando					Ceros
# Bytes	1					15

Petición Iniciar Medicion De energia						
Valor	0x02					0x00
Nombre	Comando					Ceros
# Bytes	1					15

Borrar claves						
Valor	0x03					0x00
Nombre	Comando					Ceros
# Bytes	1					15

Confirmacion autorizacion envio de fecha y hora						
Valor	0x04	-	-	-	-	0x00
Nombre	Comando	Ano	Mes	Dia	Hora	Ceros
# Bytes	1	1	1	1	4	8

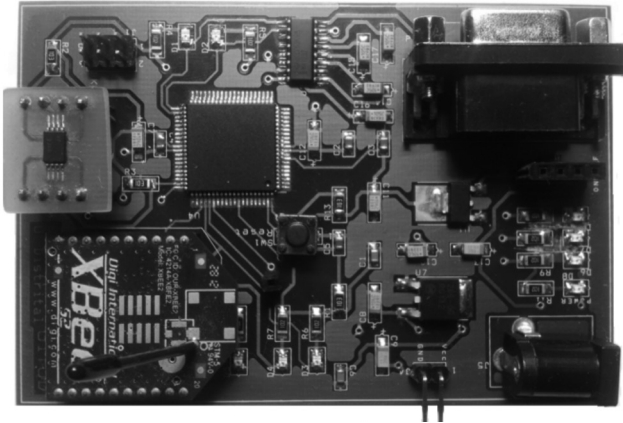
Figure 7. Types of frames sent from the concentrator to the meter

Source: Own work.

Figure 6 shows the structure of the information sent from the meter to the concentrator. This information is divided in two types: the first for voltage and current phasors measurements, frequency and power, which is sent in real time and the second for sending energy consumption which is done by request from the concentrator. Figure 7 shows the

frame structure used for a request from the concentrator to each of the meters.

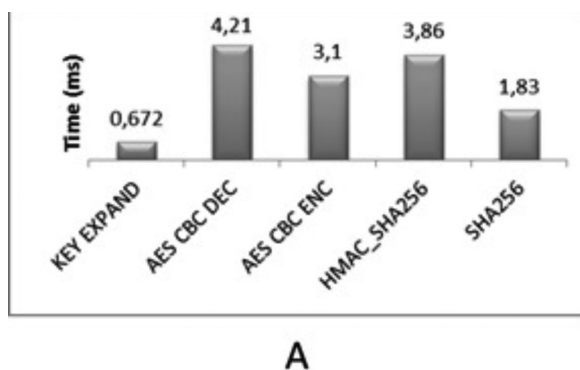
## RESULTS



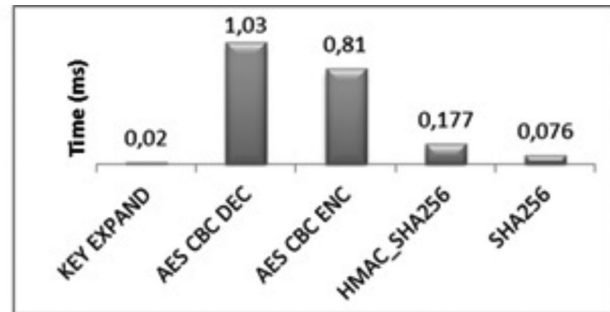
**Figure 8.** Encryption board

**Source:** Own work.

The encryption board shown in figure 8 was implemented for reading, transmission and storage of information related to the power grid state using a ZigBee transmitter. It includes information security parameters such as confidentiality, integrity and authenticity, through the implementation of the SHA256, HMAC-SHA256, KDF-SHA256 and AES256-CBC algorithms in the microcontroller included in the encryption board. Figure 9 (A) presents the measurements of running times achieved by implementing the AES256 algorithms representing 32 bits and SHA256 in the MCF51QE128 Freescale microcontroller, and figure 9 (B) shows these results in Labview under a 32 bit platform.



**A**



**B**

**Figure 9.** Runtimes of cryptographic algorithms in (A) microcontroller and (B) Labview

**Source:** Own work.

The system is controlled by the HMI in Figure 10 developed in Labview, which allows to start and stop sending real time data from each meter, to request energy consumption, to request key change, to observe measured variables in real time and to store historical measurements from each meter. Starting the encryption board the authentication and synchronization process starts, which is notified in the HMI, successfully completed this process it is possible to do the requests of figure 8 over the chosen meter.

A simulation using OPNET Modeler was carried out in order to estimate the number of meters that can be connected to the concentrator and to perform transmission of real time simultaneous information without losing data, where the following parameters were configured:

- Star topology with data transmission only from the meter to the network coordinator.
- Packet size of 512 bits per meter in the application layer.
- Transmission time between packs of 82,16 ms per meter, which includes the time employed to read information from the PMU (75,2 ms) plus delay of the authenticated encryption scheme (6,96 ms). These are enough times for electric energy management in terms of generation and consumption.

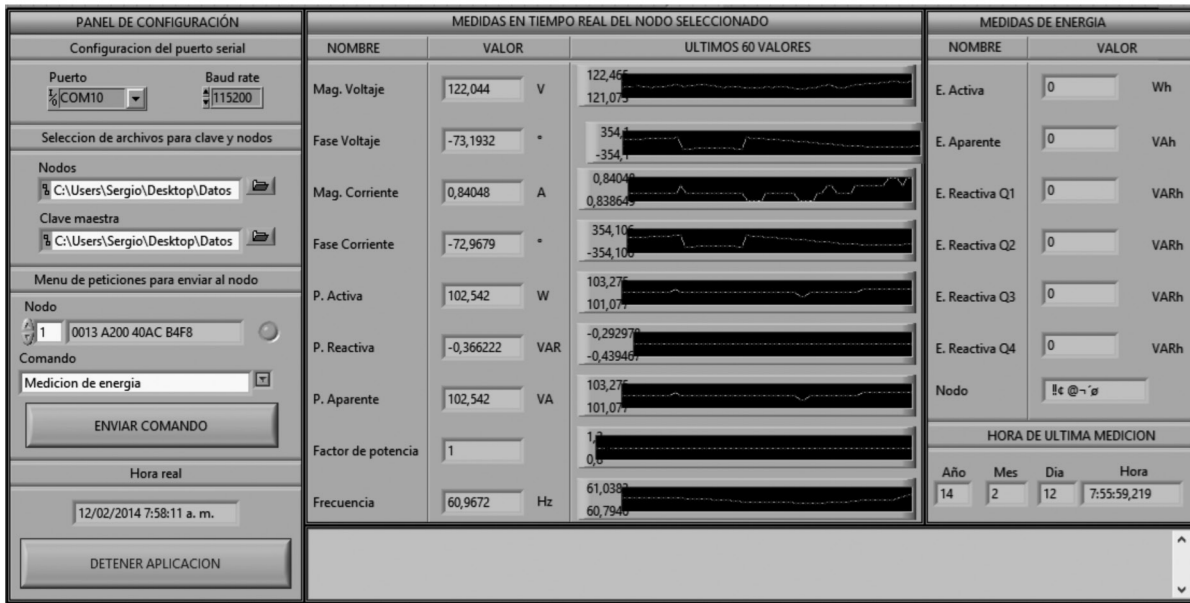


Figure 10. HMI (Human Machine Interface)

Source: Own work.

Simulation result is shown in Figure 11 (A), where the vertical axis is the time in seconds. It takes the meter to access the channel and the horizontal axis presents the number of meters in the network; the figure shows that by using simultaneously 25 meters, average delays of 90 milliseconds are obtained, being greater than the time between packs, causing loss of data. Figure 11 (B) shows the traffic received by the concentrator and channel saturation is identified from 24 meters.

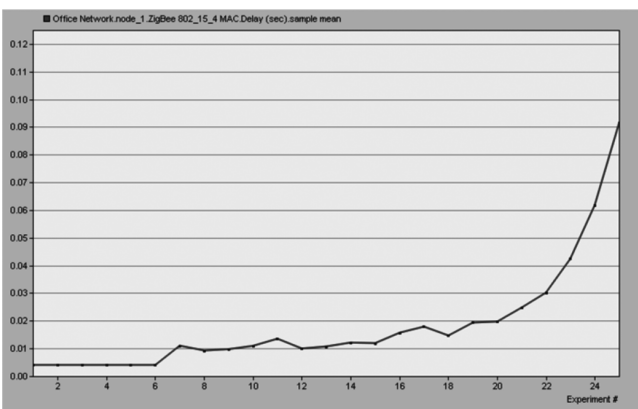
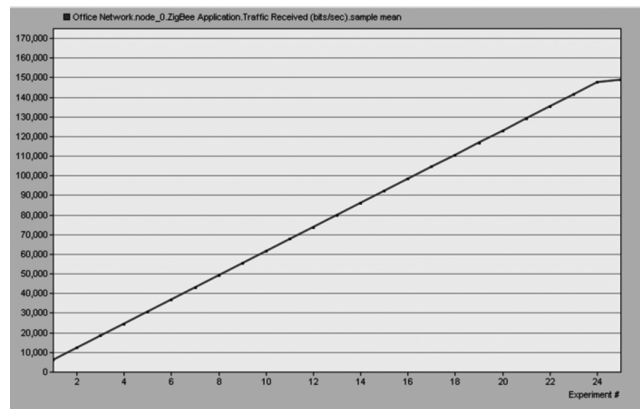


Figure 11. (A) Average access time from the meter to the channel, (B) Traffic received by the concentrator in the application layer for each of the scenarios in bits/s

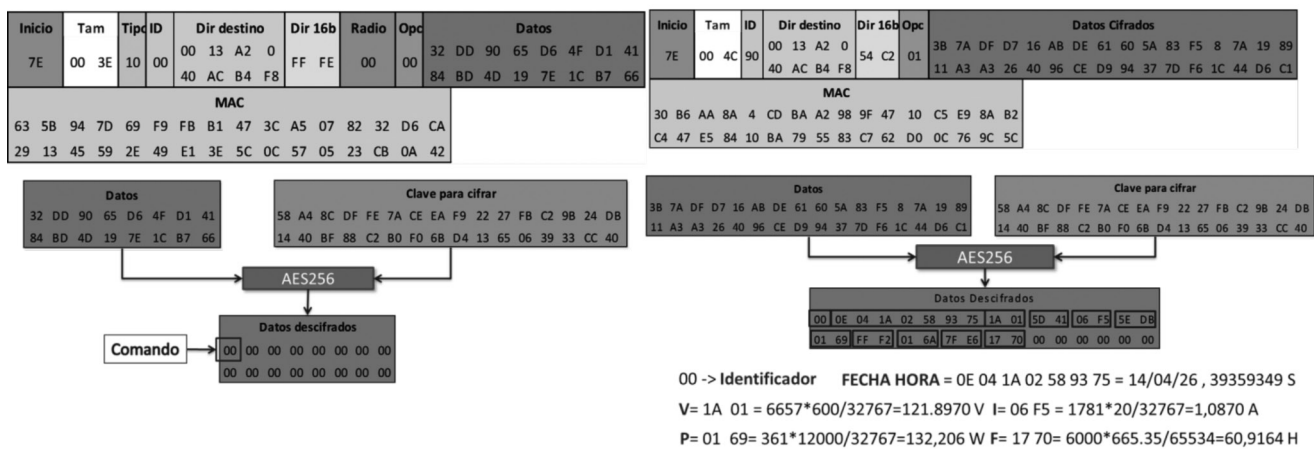
Source: Own work.

Each meter is waiting for a request from the concentrator to start a real time or energy consumption information transmission after performing the authentication and synchronization process. Figure 12 (A) shows the encapsulated request in a Zigbee API frame sent from the concentrator, by implementing the figure 3 process.



In the first step, the data field is encrypted with AES256 under the key  $k_y$ , then the MAC is calculated with the HMAC-SHA256 algorithm based on the key  $k_a$  and finally the frame is sent to the meter. When the meter receives the frame, first runs the HMAC-SHA256 algorithm to validate the MAC and then decrypts the data field with the AES256 algorithm, the result indicates the start of real time information transmission because in the “command” field a “0x00” was received.

Figure 12 (B) shows the measurement performed by one of the meters using a load of 132 W required by the concentrator, there the encrypted data field and the MAC, encapsulated in the same frame structure, are included. After receiving this frame, the concentrator validates the source address through the MAC, then decrypts the data field including the descriptor of frame “0x00” with the date and time of data measurement, current and voltage phasors, power and frequency.



**Figure 12.** (A) Request from the concentrator to the meter to start real time measurement, (B) Response from the meter

Source: Own work.

## CONCLUSIONS

A collector-meter communication system was implemented that allows monitoring energy consumption and real time state of the power grid in each of the meters associated to the network. The security of this system was achieved in two levels, the first with the design and implementation of the encryption board which protects data authenticity, integrity and privacy at the point of measurement in the power grid through the PMU, and the second level for data transmission integrating the security system with security mechanisms that Zigbee technology incorporates. This combination in the security

system implemented as last mile solution for secure and reliable access to information is the first of its kind, because it is made from the client side.

The implemented security scheme fulfills the information confidentiality, integrity and authenticity requirements using symmetric cryptographic algorithms with keys smaller than asymmetric algorithms, providing less time for information processing with the same security level.

The time employed for encryption and transmission of data collected from the PMU is enough for electric energy management in terms of generation and consumption. However, it is not recommended to use encryption when sending voltage



or frequency references to the inverters for certain events because they are greater than half cycle of the sine wave.

## ACKNOWLEDGEMENT

This work was supported by the CIDC (Centro de Investigación y Desarrollo Científico) of Universidad Distrital Francisco José de Caldas in Bogotá D.C. Colombia. Project Number 2-195-405-1 (Metodología para la implementación de un sistema de comunicaciones en microrredes eléctricas), and LIFAE Research group (Laboratorio de fuentes alternativas de energía).

## REFERENCES

- Daernen, J. & Rijnen, V. (2002). *The Design of Rijndael, AES - The Advanced Encryption Standard*. Springer.
- Dai, J.-j. & Yan, M. (2010). The design and implementation of 128-bit AES encryption in PRIME. *2010 3rd International Conference on Computer Science and Information Technology*, 345-348.
- De Craemer, K. & Deconinck, G. (2010). *Analysis of State-of-the-art Smart Metering Communication Standards*. Obtenido de Ku Leuven Repository: <https://lirias.kuleuven.be/bitstream/123456789/265822/1/SmartMeteringC>. Easter, R., & Bryson, J. (2012). Security Requirements for Cryptographic Modules. *Approved Security Functions for FIPS PUB 140-2*.
- Fan, Z. et al. (2012). Smart Grid Communications: Overview of Research Activities. *Communications Surveys & Tutorials, IEEE*, 21-38.
- Gangil, G. & Rakesh, N. (2013). Advanced Security Algorithm for Power Grid, 409-417.
- Katz, J., & Lindell, Y. (2007). *Introduction to Modern Cryptography*. Chapman & Hall/.
- Khalifa, T., Naik, K. & Nayak, A. (2011). A Survey of Communication Protocols for Automatic Meter Reading Applications. *IEEE Communications Surveys & Tutorials*, 168-182.
- Khurana, H., Bobba, R., Yardley, T., Agarwal, P. & Heine, E. (2010). Design Principles for Power Grid Cyber-Infrastructure Authentication Protocols. *2010 43rd Hawaii International Conference on System Sciences*, 1-10.
- Luan, S.-W., Teng, J.-H., Chan, S.-Y. & Hwang, L.-C. (2009). Development of a smart power meter for AMI based on ZigBee communication. *2009 International Conference on Power Electronics and Drive Systems (PEDS)*, 661-665.
- NIST. (2001). Advanced Encryption Standard (AES) Federal. *Federal Information Processing Standards Publication FIPS PUB 197*, 47.
- NIST. (2007). Recommendation for Key Management. *NIST Special Publication 800-57*, 142.
- NIST. (2008). The Keyed-Hash Message Authentication Code. *Federal Information Processing Standards Publication FIPS PUB 198-1*, 8.
- NIST. (2010). *Guidelines for Smart Grid Cyber Security: Vol. 2, Privacy and the Smart Grid*. From the National Institute of Standards and Technology: [www.nist.gov](http://www.nist.gov)
- NIST. (2010). *Nistir 7628 Guidelines for Smart Grid Cyber Security*. From The National Institute of Standards and Technology: <http://csrc.nist.gov/publications/nistir/ir7628/introduction-to-nistir-7628.pdf>
- NIST. (2011). Recommendation for Existing Application-Specific Key Derivation Functions. *Federal Information Processing Standards Publication FIPS PUB 800-135*.
- NIST. (2012). Secure Hash Standard (SHS). *Federal Information Processing Standards Publication FIPS PUB 180-4*.
- Peng, Z., Elkeelany, O. & Layton, M. (2010). An implementation of secured Smart Grid Ethernet communications using AES. *Proceedings of the IEEE SoutheastCon 2010 (SoutheastCon)*, 394-397.
- Seshabhattar, S., Priyanka, Y., Krier, P. & Engels, D. (2011). Hummingbird Key Establishment Protocol For Low- Power ZigBee. *IEEE Consumer Communications and Network*, 447-451.
- Stallings, W. (2011). *Network Security Essentials: Applications and Standards*.

## Potential application of ivim and dwi imaging in parkinson's disease

### Aplicación potencial de imágenes ivim y dwi en la enfermedad de parkinson

Gloria M. Cruz\*, Shengdong Nie\*\*, Lijia Wang\*\*\*

**Fecha de recepción:** June 10th, 2014

**Fecha de aceptación:** November 4th, 2014

**Citation / Para citar este artículo:** Cruz, G., Nie, S., & Wang, L. (2014). Potential application of IVIM and DWI imaging in Parkinson's disease. *Revista Tecnura*, 18 (Edición especial doctorado), 80–89. doi: 10.14483/udistrital.jour.tecnura.2014.DSE1.a07

#### ABSTRACT

Parkinson's disease (PD) is a progressive degenerative neurological condition, which origin remains unclear. We are interested in proposing the study of blood flow in the substantia nigra (SN) in PD patients, based on findings that demonstrated relative hypoactivity in PD patients located to subthalamic nucleus and SN. It is believed that this hypoactivity may suggest changes in the blood flow to the SN, where the particular loss of dopaminergic neurons occurs.

The method used is the Incoherent Motion Intravoxel (IVIM) that allows measurement of blood flow to the microvascular level and recently has been producing high resolution quantitative perfusion maps.

This paper proposes to measure the perfusion in PD patients and find any correlation with neural activity and water displacements within the tissue. Assuming decreasing the local perfusion suggests the possible impairments that affect the neural activity in PD causing the progressive death of neurons in the SN.

**Keywords:** Diffusion Weighted Imaging (DWI), Intravoxel incoherent motion (IVIM), Parkinson's disease (PD), Substantia nigra (SN).

#### RESUMEN

La enfermedad de Parkinson (EP) es una afección neurológica progresivamente degenerativa, con un origen aún desconocido. Estamos

- 
- \* MSc. Received her B.A degree in Biomedical Engineering at Universidad Antonio Nariño, Colombia, in 2000, the MSc. degree in Biomedical Engineer at The Beijing Institute of Technology, China, in 2010. She is currently a Senior Research Lecturer in Neuroscience and Neuro-computing and pursuing his PhD. degree within The University of Shanghai for Science and Technology. Her current researches interesting include Diffusion Tensor Imaging, Diffusion Weight Imaging, Perfusion Imaging, cancer and neuronal degenerative diseases. E-mail: g\_milena@yahoo.com
- \*\* PhD. Received his Bachelor degree in Mathematics and Control Theory from Shandong University, China, in 1984. He was an assistant engineer in Ministry of Defense for Simulation System Laboratory and Department of Radiology at the Computer Medical College, during 1984-1990. He received his Master's degree in Automation Engineering from Electrical Shandong University of Science and Technology. He received his PhD degree in Biomedical Engineering from Jiaotong University, China, in 2000. He is now associate Professor and leader in University of Shanghai for Science and Technology at the Institute Medical Imaging Engineering. E-mail: nsd4647@163.com
- \*\*\* PhD. She was born in 1984. She accepted her physics PhD degree from East China Normal University, China, on July, 2014. Her project is mainly focused on MRI techniques mainly including fully automated segmentation of cine cardiac MRI images. She also worked on fMRI study of visual illusory motion. Four paper and 7 patents have been published. Now she is working on MRI Pulse sequence design. E-mail: wanglijiamri@gmail.com

interesados en proponer el estudio del flujo sanguíneo en la sustancia negra (SN) en los pacientes con Parkinson, basados en hallazgos que han demostrado la relativa hipoactividad localizada en el núcleo subtalámico y la SN. Se cree que esta hipoactividad puede sugerir cambios en el fluido sanguíneo de la SN, donde ocurre la particular pérdida de neuronas dopaminérgicas.

El método a usar es el movimiento incoherente Intravoxel (IVIM) que permite la medición del flujo sanguíneo a nivel microvascular; además, recientemente ha producido una alta resolución de mapas de perfusión, permitiendo ser cuantificados.

El presente artículo plantea la posibilidad de medir la perfusión en pacientes con EP y encontrar la correlación de la actividad neuronal y de los desplazamientos de agua dentro del tejido a través de imágenes DWI e IVIM, suponiendo que la disminución de la perfusión local en la SN en los pacientes con EP interfiere en la actividad neuronal, siendo esta una de las posibles causas de la muerte progresiva de las neuronas en la sustancia negra.

**Palabras clave:** enfermedad de Parkinson (EP); Movimiento Incoherente Intravoxel (IVIM); Imágenes DWI; Sustancia negra (SN).

## INTRODUCTION

Diffusion Weighted Imaging (DWI) (LeBihan *et al.*, 1986) is a Magnetic resonance imaging (MRI) method, which allows the movements of the water molecules to be quantified (LeBihan, Moonen, van Zijl, Pekar, & DesPres, 1991), *in vivo* and non-invasively. Presently DWI has become an important technique in the characterization and detection of neurodegenerative diseases, such as PD (Köllensperger, Seppi, Liener, & Al, 2007; Meijer *et al.*, 2013; Nicoletti *et al.*, 2006; Seppi *et al.*, 2006)

The movements of the water molecules, known as Brownian motion, is due to thermal agitation and is highly influenced by the cellular environment. Tirosh & Nevo (2013) suggest a possible reduction in water displacement that accompanies the neuronal activity, but neuronal activity was possibly affected by other physiological mechanisms as a consequence from Blood Oxygenation Level (BOLD) (Ogawa, Lee, Nayak, & Glynn, 1990) and blood flow. Otherwise, Kohno *et al.* (2009) suggest that the changes in DWI signal are not due to a BOLD effect because the diffusion response was less correlated with the changes in oxygenated, deoxygenated, and total hemoglobin. Even, they suggested that a decrease in water

diffusion reflects early events that precede the vascular responses, which could originate from changes in the extravascular tissue (Kohno *et al.*, 2009). Would be interesting to study on finding evidence to suggest that the decrease in the diffusion measure, really are influenced by the effects of perfusion in PD patients that result in neuronal loss and possible symptoms in PD. An example of evidence that suggest changes in the region of interest along a line between the SN and the lower part of the putamen and caudate complex of PD patients, in which most of the nigrostriatal dopaminergic neurons are included (Yoshikawa, 2004). Another important study by Vaillancourt *et al.*, showed diffusion values in rostral, middle, and caudal region of the SN distinguishes in early stage PD patients from healthy controls (Vaillancourt *et al.*, 2009), and structural abnormalities in the SN (Du *et al.*, 2011; Péran, Cherubini, Assogna, & Al., 2010). Although the correlation between diffusion measures and pathological changes like perfusion in PD had not evidence, it is a primary concern for further researches to emphasize the importance of the SN.

BOLD functional MRI has great potential to serve as a non-invasive biomarker in PD (Prodoehl *et al.*, 2010; Spraker *et al.*, 2010) these studies showed hypoactives areas in response to a certain task in the basal ganglia, thalamus, cortical regions

and SN. But BOLD is a method that faces several dependences with cerebral blood flow, cerebral blood volume, and blood oxygenation (Federau et al., 2012; Malonek et al., 1997). Also the spatial resolution is limited due to contribution from veins draining in the sides of activation (Turner, 2002). Generally we must use a series post-processing techniques to improve the spatial resolution. The recently advance techniques and functional imaging IVIM weighted MRI (LeBihan & Turner, 1992) could have a higher spatial correlation with perfusion and neural activation (Federau et al., 2012), even if we consider that IVIM concept has contributed to better understand the different vasculature components to the BOLD functional MRI signal (Le Bihan, 2012; Ogawa et al., 1993). Some of the others good examples or reasons that we encourage the use of IVIM is due to imaging demonstrated ischemic cerebral injury 2 hours post-occlusion in all cats, while T2-weighted imaging failed to show clear evidence of injury until 2–6 hours (Ide et al., 1993).

## IVIM

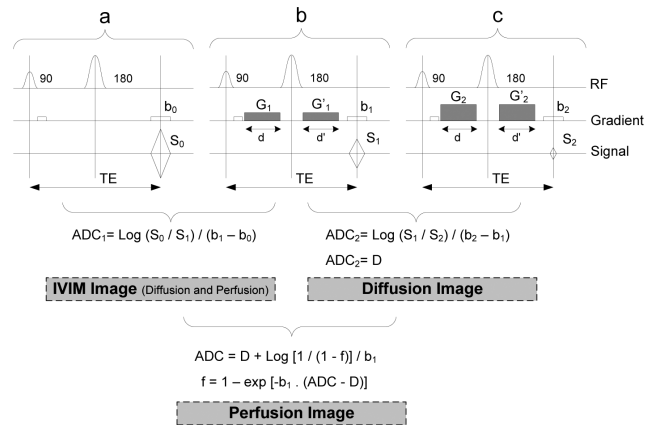
IVIM weighted MRI (LeBihan & Turner 1992) measurements involve two movements in each voxel of biological tissue: the molecular diffusion and the microcirculation of water (known as perfusion). These two movements can be quantified in terms of the apparent diffusion coefficient (ADC) (LeBihan & Turner, 1992). IVIM images are generated from diffusion weighted images, with sequences that have different sensitivity to the type of vessels and also according to the sensitivity range of motion which is known as  $b$  values.

LeBihan (2008) indicated that low  $b$  values, less than  $200 \text{ sec/mm}^2$ , make the signal from large vessels with rapid disappearing flow rate; meanwhile higher  $b$  values above  $200 \text{ sec/mm}^2$  make it possible to obtain signals of small vessels with slow flow that contributes to the acquisition of IVIM signal (LeBihan & Turner, 1992; LeBihan, 2008).

The apparent diffusion coefficient (ADC) can be calculated by using the equation (1):

$$ADC = \text{Log}(S_0/S_1)/(b_1 - b_0) \quad (1)$$

Where  $b_1$  and  $b_0$  are the gradient factors of  $S_1$  and  $S_0$  sequences. According to this equation, IVIM theory can obtain the IVIM Image (which contains diffusion and perfusion) and the pure diffusion image called  $D$ .



**Figure 1.** Separation of diffusion and perfusion. Three sequences are used. (a) Without diffusion weighted, also called standard sequence; (b) With stronger additional gradient  $G_1$ ; (c) Diffusion weighted by stronger additional gradient pulses  $G_2$

**Source:** Cruz, Li, Xu, & Zhang (2010).

Based on Figure 1, an independent separation of  $D$  and  $f$  can be obtained from two IVIM images acquired at different gradient factors  $b$ . The separation and quantification of diffusion and perfusion images are calculated using third sequence  $S_2$  (LeBihan et al., 1988). This sequence, (c), is identical to the sequence  $S_1$ , (b), except that the additional gradient pulse is stronger, and the echo attenuation due to diffusion is higher.

Combining the first IVIM image obtained from  $S_0$  (a) and  $S_1$  (b), and the pure diffusion image obtained from  $S_1$  (b) and  $S_2$  (c) is possible to obtain a pure perfusion image  $f$  as equation (2) follows:

$$f = 1 - \exp[-b_1 \cdot (ADC - D)] \quad (2)$$



Where  $b_1$  is the gradient factors of  $S_1$ , ADC is the IVIM image obtained from  $S_0$  (a) and  $S_1$  (b), and  $D$  is the pure diffusion image obtained from  $S_1$  (b) and  $S_2$  (c).

## PD

Initially described in 1817 by James Parkinson, PD is characterized by the selective loss of dopaminergic neurons in the SN zona compacta (SNc) (Braak, Rüb, Gai, & Del Tredici, 2003). The motor symptoms appear when at least 50-80% of dopaminergic neurons have died in the SN. This limits the effectiveness of potential treatments due to the low number of remaining neurons. According to Barcia *et al.* (2005) and Issidorides (1971), the EP can be related to disturbances of the microcirculation within the SN, which activates the pathophysiological cascade, which ultimately leads to the loss of dopaminergic neurons. However, another equally interesting theory by Kitagawa *et al.*, related to changes in the cellular balance of antioxidants/oxidants due to increased free radicals in neurons (Kitagawa *et al.*, 1990) They demonstrated that oxygen free radicals can be generated as a consequence of short periods of ischemia and neuronal death in vulnerable areas of the brain (Kitagawa *et al.*, 1990; Sasaki *et al.*, 2011)

In this work we propose to analyze IVIM technique to evaluate regional blood supply and diffusion measurements, and thus examine the correlation with regional atrophy in the SN of PD patients.

## SN

SN has been divided into two macroscopic portions by their neurotransmitters, a dorsal portion rich in neurons containing neuromelanin called zona compacta (SNc) (Parent & Hazrati, 1995). The more ventral region is a portion with ovoid shape and lower neuron density called zona reticular

(SNr), it has also a lateral portion. Functionally SN is divided in the inferior (caudal) and posterior (dorsal) in SNc; and the superior (rostral) and anterior (ventral) in SNr (Massey & Yousry, 2010).

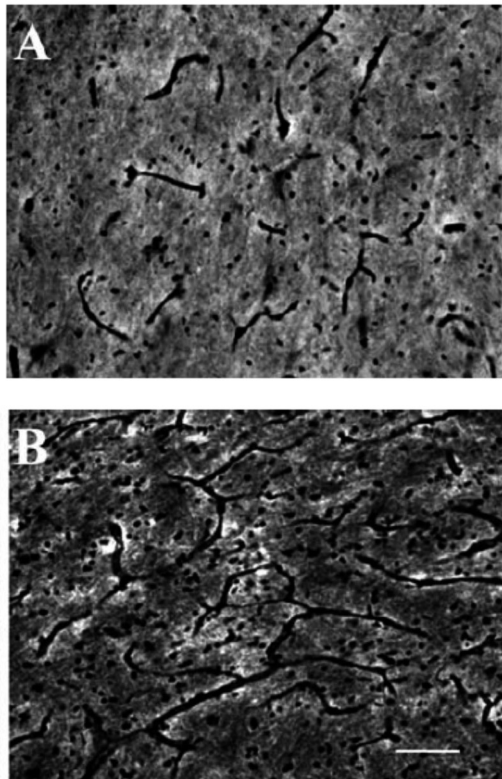
## Vascularization in SN

The SN is supplied with blood by four pial arteries: the basilar, the posterior cerebral, the posterior communicating and the choroid (Knox & Finley, 1936). Most of the parenchymal arteries supplying the SN also supply neighbouring nuclei (Cipolla, 2009; Knox & Finley, 1936). Within the SN, the capillary network of the SNc is much denser than in the SNr (Scheibel & Tomiyasu, 1980). SNc consists of rather densely arrayed vascular loops and whorls within which the neurons are situated. And SNr consists of longer blood vessels extending toward cerebral peduncle (Scheibel & Tomiyasu, 1980).

Observations were made of neurons of the SN by Issidorides (1971). He found that the melanin-containing neurons of the SNc in the normal brain have a close spatial relationship with the blood circulation. The capillary walls appear fused to the membranes of neuronal perikarya. In the Parkinsonian SNc since the close contact between nigral neuron and the capillary is lost (Issidorides, 1971). The width of this area ranged from a simple fissure, and seemed to increase with duration of disease. These findings suggest that this is due to the infiltration of the proliferated glia between cell surface and capillary wall (Issidorides, 1971; Hassler, 1938).

These changes in vascularization (Figure 2) may therefore modify the neuronal availability of blood nutrients, blood cells or toxic substances and neuronal susceptibility to parkinsonism (Barcia *et al.*, 2005). Despite the increased number of blood vessels in the SN of the modeling PD in primates monkeys, they found no changes in the volume of the SNc (Barcia *et al.*, 2005).





**Figure 2.** Photomicrographs of vascularization evidenced by reticulium staining in the zona compacta (SNc) of a control monkey (A) and a Modeling Parkinson's Disease in Primates (MPTP)-treated monkey (B)

**Source:** Barcia et al. (2005).

Within the SNc, the pathology is more pronounced in the caudal and the lateral portion (Hassler, 1938; Jellinger, 1986), in the vascularized portion by perforating arteries originating from the vascular territory of the perforating branches that originate from the basilar bifurcation and posterior cerebral artery, mesencephalic arteries. As same, others as dopaminergic midbrain nucleus German et al., 1989), in the locus ceruleus (Ohtsuka et al., 2013; Zweig et al., 1993), and monoaminergic neurons in the pons and medulla oblongata (Halliday et al., 1988).

PD has a high incidence in people over 50 years old with a slowly progressive course; consequently, multiple anatomical variations of the circle of Willis and/or structural changes in their perforating arteries, possibility can cause reduced blood

flow to the SN, as well as others nucleus. Although the reduction in blood flow and nutrient delivery may initially be not clinically detectable, however, chronic persistence could ultimately to reduced thus compromising neuronal-glia interaction (De la Torre, 1994) Because the cerebral blood flow is normally regulated by the regional metabolic activity of neurons (Raichle et al., 1976). Recent research showed that cells implanted in the posterior region of the circle of Willis improved the severity of disease (Brazzini et al., 2010).

### SN IN PD

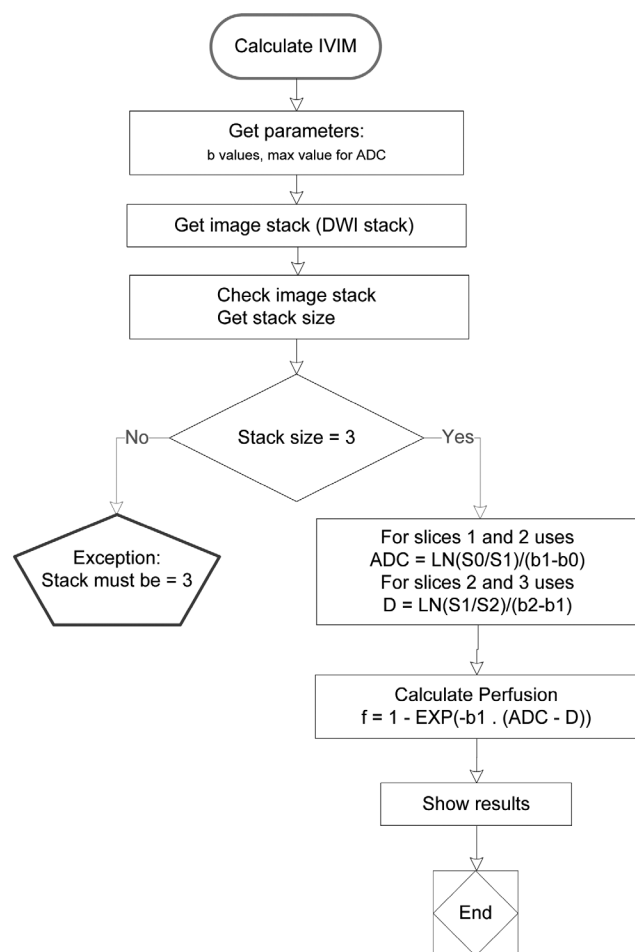
In PD has the highest degree of neuronal loss in the SNc (Hirsch, Graybiel, & Agid, 1988), but it was more severely affected in the ventral (98%) than dorsal and lateral tiers (Fearnley & Lees, 1991). Another study with Neuromelanin-sensitive MRI was able to visualize changes associated with neuronal loss, the most significant signal attenuation was detected in the lateral part and most severely affected in PD (Ohtsuka et al., 2013).

The cause of the vulnerability of different regions is unknown. Apparently some of the reasons or features are because the neurons are more sensitive to oxidative stress in PD, which is known as the increased iron concentrations in the SN (EC Hirsch, 2009). Furthermore, an increased density of lactoferrin receptors has been reported on dopaminergic neurons and blood vessels (EC Hirsch & Faucheux, 1998; EC Hirsch, 2009).

Other a good correlation between PD patients and controls with the BOLD signal versus the performance of motor tasks and symptom-specific disease severity was made by Prodoehl et al. (2010) and Spraker et al., (2010). They showed the location on each anatomical region of the basal ganglia, primary motor cortex, supplementary motor area and SN were hypoactive in PD patients. Even the hypoactivity was observed in PD patients who had not yet started medication to subthalamic nucleus and SN (Spraker et al., 2010). In addition to these findings, one of the major responses that

accompanies changes in neural activity is a localized change in cerebral hemodynamics: changes as cerebral blood flow, volume and blood oxygenation (Ogawa et al., 1993); also when a neuron increases the metabolic demands of oxygen and nutrients, they are extracted from the blood, meanwhile increases the local perfusion through vascular coupling (Roy & Sherrington, 1890).

### Software application for ADC and IVIM



**Figure 3.** IVIM main flow diagram

**Source:** Own work.

With the aim of implementing the IVIM theory above described and also trying to emphasize the rich information that ADC maps can give us, an “open source” application was implemented in order to

generate ADC, diffusion and perfusion maps. The software was developed in Java language, as a plugin for ImageJ. ImageJ is a public domain Java image processing program (<http://rsbweb.nih.gov/ij/>). The logical structure of the program gives the user the possibility to perform two analyses: 1) IVIM Analysis: calculates the IVIM map, the pure diffusion map and the perfusion map; 2) ADC Analysis: calculates the ADC map for two or more slices by using a fitting algorithm.

The following flow diagram (Figure 3) implements the main aspects of IVIM calculation:

On the other hand, the ADC analysis performs the ADC maps from multiple DWI slices with different b values. When two slices are introduced, with its corresponding b values, the software will perform an ADC analysis based on the equation (1). And, for more than two slices a fitting algorithm will be used. This fitting algorithm is based on the famous simplex method. The simplex algorithm, created by the American mathematician George Dantzig in 1947, is a popular algorithm for numerically solving linear programming problems. This method uses the concept of a simplex, which is a polytope of  $N + 1$  vertices in  $N$  dimensions: a line segment in one dimension, a triangle in two dimensions, a tetrahedron in three-dimensional space, and so forth. Each ADC value in the map will be expressed in terms of  $10^{-3}$  mm<sup>2</sup>/sec.

### CONCLUSIONS

Basically the IVIM method an engineering point of view allows us to suggest that diffusion measures are excellent to proposing novel methods for development and planning of logic solutions to follow the disease progression and find new potential biomarkers in PD. Also authors such as Du et al. (2011) and Vaillancourt et al. (2009) proposed to improve and develop methods for separation of SN to distinguish SNc from SNr, as well as it is a necessary development novel tool for analyses and compare iron deposition, perfusion and diffusion within the SN, that can help to know the progression of the

disease to understand the correlation between these biomarkers. The even other unclear boundary is between the sub-thalamic nucleus and the SN in the dorsal region (Du et al., 2011; Vaillancourt et al., 2009).

We can also use others different MRI techniques to obtain measures of perfusion information (Calamante et al., 1999), that we don't propose in this paper, but they should be used with the same aim to understand the possible changes that produced the death of the dopaminergic neurons to avoid the appearance of the symptoms.

Diffusion Tensor Imaging (Mori & Zhang, 2006) provides excellent sensitivity and specificity in PD to identifier structural abnormalities in the SN (Du et al., 2011; Péran et al., 2010). These results were also consistent with the strong linear relationship with iron concentrations, particularly in the caudal region in SN, even between individual subjects (Vaillancourt et al., 2009). Another reason for this interesting research is the possible reduction in water displacement that accompanies the neuronal activity, which was possibly affected by the blood oxygenation level and blood flow (Tirosh & Nevo, 2013). In summary, our objective is to identify markers that can aid in diagnosis, disease progression monitoring and long-term drug impact analysis.

The effectiveness of the software depends on the correct acquisition of images. Due to the difficulty of getting good quality diffusion images in the brain with PD, the actual results lack of statistical support about the effectiveness of IVIM method. For that reason, this work only can present the software for further studies, which is expected the possibility to have more image data. The images used to test the IVIM software are just simple testing images. We want to open the possibility to use this application for future research.

Actually the software deficiency of preprocessing to reduce the noise, deblurring and adjust contrast, this is because the aim of this software was to develop an algorithm to perform IVIM theory; the focus was to implement the mathematical

processing. In future stages preprocessing tools can be developed. And others imaging computational methods and software tools can improve the analysis in future research that are widely used to process and analyze DWI data (Hasan, Walimuni, Abid, & Hahn, 2011).

## ACKNOWLEDGMENTS

The authors thank Chinese Scholarship Council award.

## REFERENCES

- Barcia, C. et al. (2005). Changes in vascularization in substantia nigra pars compacta of monkeys rendered parkinsonian. *Journal of Neural Transmission*, 112, 1237-1248. doi:10.1007/s00702-004-0256-2
- Braak, H., Rüb, U., Gai, W., & Del Tredici, K. (2003). Idiopathic Parkinson's disease: possible routes by which vulnerable neuronal types may be subject to neuroinvasion by an unknown pathogen. *J Neural Transmission*, 110(5), 517-36.
- Brazzini, A. et al. (2010). Intraarterial autologous implantation of adult stem cells for patients with Parkinson disease. *Journal of Vascular and Interventional Radiology: JVIR*, 21(4), 443-51. doi:10.1016/j.jvir.2010.01.008
- Calamante, F. et al. (1999). Measuring cerebral blood flow using magnetic resonance imaging techniques. *Journal of Cerebral Blood Flow and Metabolism: Official Journal of the International Society of Cerebral Blood Flow and Metabolism*, 19, 701-735. doi:10.1097/00004647-199907000-00001
- Cipolla, M. (2009). The Cerebral Circulation. In S. R. (CA): M. & C. L. Sciences (Ed.), *The Cerebral Circulation*.
- Cruz, G., Li, Q., Xu, L., & Zhang, W. (2010). Differentiation of diffusion coefficients to distinguish malignant and benign tumor. *Journal of X-Ray Science and Technology*, 18(3), 235-49. doi:10.3233/XST-2010-0257
- De la Torre, J. C. (1994). Impaired brain microcirculation may trigger Alzheimer's disease. *Neuros-*

- science and Biobehavioral Reviews*. doi:10.1016/0149-7634(94)90052-3
- Du, G. et al. (2011). Combined R2\* and diffusion tensor imaging changes in the substantia nigra in Parkinson's disease. *Movement Disorders*, 26(9), 1627-1632.
- Fearnley, J., & Lees, A. (1991). Ageing and Parkinson's disease: substantia nigra regional selectivity. *Brain*, 114, 2283-2301.
- Federau, C. et al. (2012). Quantitative Measurement of Brain Perfusion with Intravoxel, 265(3).
- German, D. et al. (1989). Midbrain dopaminergic cell loss in Parkinson's disease: computer visualization. *Ann Neurol*, 26(4), 507-14.
- Halliday, G. et al. (1988). Distribution of monoamine-synthesizing neurons in the human medulla oblongata. *J Comp Neurol*, 273(3), 301-17.
- Hasan, K. M., Walimuni, I. S., Abid, H., & Hahn, K. (2011). A review of diffusion tensor magnetic resonance imaging computational methods and software tools. *Computers in Biology and Medicine*, 41(12), 1062-1072. doi:10.1016/j.combiomed.2010.10.008
- Hassler, R. (1938). [Zur Pathologie der Paralysis agitans und des Postenzephalitischen Parkinsonismus]. *J Psychol Neurol*, 48, 387-476 [in German].
- Hirsch, E. (2009). Iron transport in Parkinson's disease. *Parkinsonism & Related Disorders*, 15 Suppl 3, S209-S211. doi:10.1016/S1353-8020(09)70816-8
- Hirsch, E. & Faucheux, B. (1998). Iron metabolism and Parkinson's disease. *Mov Disord*, 13(1), 39-45.
- Hirsch, E. Graybiel, A. & Agid, Y. (1988). Melanized dopaminergic neurons are differentially susceptible to degeneration in Parkinson's disease. *Nature*, 334(6180), 345-348.
- Ide, H. et al. (1993). Correlation between somatosensory-evoked potentials and magnetic resonance imaging of focal cerebral ischemia in cats. *Surgical Neurology*, 40, 216-223. doi:10.1016/0090-3019(93)90070-H
- Issidorides, M. R. (1971). Neuronal vascular relationships in the zona compacta of normal and parkinsonian substantia nigra. *Brain Research*, 25(2), 289-299. doi:10.1016/0006-8993(71)90439-2
- Jellinger, K. (1986). Overview of morphological changes in Parkinson's disease. *Adv. Neurol*, 45, 1-18.
- Kitagawa, K. et al. (1990). Free radical generation during brief period of cerebral ischemia may trigger delayed neuronal death. *Neuroscience*, 35(3), 551-558. doi:10.1016/0306-4522(90)90328-2
- Knox, H. & Finley, M. D. (1936). Angio-architecture of the substantia nigra and its pathogenic significance. *Arch NeurPsych*, 36(1), 118-127.
- Kohno, S. et al. (2009). Water-diffusion slowdown in the human visual cortex upon visual stimulation precedes vascular responses. *Neuroscience Research*, 65, S131. doi:10.1016/j.neures.2009.09.634
- Köllensperger, M., Seppi, K., Liener, C. & Al, E. (2007). Diffusion weighted imaging best discriminates PD from MSA-P: A comparison with tilt table testing and heart MIBG scintigraphy. *Mov Disord*, 22(12), 1771-1776.
- Le Bihan, D. (2012). Diffusion, confusion and functional MRI. *NeuroImage*, 62(2), 1131-1136. doi:10.1016/j.neuroimage.2011.09.058
- LeBihan, D. & Turner, R. (1992). The capillary network: a link between IVIM and classical perfusion. *Magnetic Resonance in Medicine: Official Journal of the Society of Magnetic Resonance in Medicine / Society of Magnetic Resonance in Medicine*, 27(1), 171-178. Retrieved from <http://www.ncbi.nlm.nih.gov/pubmed/1435202>
- LeBihan, D. (2008). Intravoxel Incoherent Motion Perfusion MR Imaging: A Wake-Up Call. *Radiology*, 249(3), 748-752.
- LeBihan, D. et al. (1988). Separation of diffusion and perfusion in intravoxel incoherent motion MR imaging. *Radiology*, 168, 497-505. doi:10.1148/radiology.168.2.3393671
- LeBihan, D. et al. (1986). MR imaging of intravoxel incoherent motions: application to diffusion and perfusion in neurologic disorders. *Radiology*, 161(2), 401-407.
- LeBihan, D. et al. (1991). Measuring random microscopic motion of water in tissues with MR imaging: A cat brain study. *J Comput Assist Tomogr*, 15(1), 19-25.



- LeBihan, D., & Turner, R. (1992). The capillary network: A link between IVIM and classical perfusion. *Magnetic Resonance in Medicine: Official Journal of the Society of Magnetic Resonance in Medicine / Society of Magnetic Resonance in Medicine*, 27(1), 171-178.
- Malonek, D. et al. (1997). Vascular imprints of neuronal activity: Relationships between the dynamics of cortical blood flow, oxygenation, and volume changes. *Proceedings of the National Academy of Sciences*, 9414826-14831.
- Massey, L. & Yousry, T. (2010). Anatomy of the substantia nigra and subthalamic nucleus on MR imaging. *Neuroimaging Clinics of North America*, 20(1), 7-27. doi:10.1016/j.nic.2009.10.001
- Meijer, F. J. et al. (2013). Update on diffusion MRI in Parkinson's disease and atypical parkinsonism. *Journal of the Neurological Sciences*, 332(1-2), 21-9. doi:10.1016/j.jns.2013.06.032
- Mori, S. & Zhang, J. (2006). *Principles of diffusion tensor imaging and its applications to basic neuroscience research*. *Neuron*, 51, 527-539.
- Nicoletti, G. et al. (2006). Imaging of Middle Cerebellar Peduncle Width : Differentiation of Multiple System Atrophy from Purpose : Methods : Results : Conclusion: *Radiology*, 239(3), 825-830.
- Ogawa, S., Lee, T. M., Nayak, A. S. & Glynn, P. (1990). Oxygenation-sensitive contrast in magnetic resonance image of rodent brain at high magnetic fields. *Magnetic Resonance in Medicine*, 14, 68-78. doi:10.1002/mrm.1910140108
- Ogawa, S. et al. (1993). Functional brain mapping by blood oxygenation level-dependent contrast magnetic resonance imaging. A comparison of signal characteristics with a biophysical model. *Biophysical Journal*, 64, 803-812. doi:10.1016/S0006-3495(93)81441-3
- Ohtsuka, C. et al. (2013). Changes in substantia nigra and locus coeruleus in patients with early-stage Parkinson's disease using neuromelanin-sensitive MR imaging. *Neuroscience Letters*, 541, 93-98. doi:10.1016/j.neulet.2013.02.012
- Parent, A. & Hazrati, L.-N. (1995). Functional anatomy of the basal ganglia. II. The place of subthalamic nucleus and external pallidum in basal ganglia circuitry. *Brain Research Reviews*, 20(1), 128-154. doi:10.1016/0165-0173(94)00008-D
- Péran, P., Cherubini, A., Assogna, F. & Al., E. (2010). Magnetic resonance imaging markers of Parkinson's disease nigrostriatal signature. *Brain*, 133, 3423-3433.
- Prodoehl, J. et al. (2010). Blood oxygenation level-dependent activation in basal ganglia nuclei relates to specific symptoms in de novo Parkinson's disease. *Mov. Disord*, 25(13), 2035-2043. doi:10.1002/mds.23360.Blood
- Raichle, M. et al. (1976). Correlation between regional cerebral blood flow and oxidative metabolism. In vivo studies in man. *Arch Neurol*, 33(8), 523-526.
- Roy, C. S. & Sherrington, C. S. (1890). On the Regulation of the Blood-supply of the Brain. *The Journal of Physiology*, 11, 85-158.17. doi:10.1152/jappphysiol.00257.2010
- Sasaki, T. et al. (2011). SIK2 Is a Key Regulator for Neuronal Survival after Ischemia via TORC1-CREB. *Neuron*, 69, 106-119. doi:10.1016/j.neuron.2010.12.004
- Scheibel, A. B. & Tomiyasu, U. (1980). A dendritic-vascular relationship in the substantia nigra. *Experimental Neurology*, 70(3), 717-720. doi:10.1016/0014-4886(80)90198-3
- Seppi, K. et al. (2006). Progression of putaminal degeneration in multiple system atrophy: A serial diffusion MR study. *NeuroImage*, 31(1), 240-245. doi:10.1016/j.neuroimage.2005.12.006
- Spraker, M. B. et al. (2010). Basal ganglia hypoactivity during grip force in drug naïve Parkinson's disease. *Human Brain Mapping*, 31(12), 1928-1941. doi:10.1002/hbm.20987
- Tirosh, N. & Nevo, U. (2013). Neuronal activity significantly reduces water displacement: DWI of a vital rat spinal cord with no hemodynamic effect. *NeuroImage*, 76, 98-107. doi:10.1016/j.neuroimage.2013.02.065
- Turner, R. (2002). How Much Cortex Can a Vein Drain? Downstream Dilution of Activation-Related Cerebral Blood Oxygenation Changes. *NeuroImage*, 16(4), 1062-1067. doi:10.1006/nimg.2002.1082



Vaillancourt, D. et al. (2009). High-resolution diffusion tensor imaging in the substantia nigra of de novo Parkinson disease. *Neurology*, 72(16), 1378-1384.

Yoshikawa, K. (2004). Early pathological changes in the parkinsonian brain demonstrated by

diffusion tensor MRI. *Journal of Neurology, Neurosurgery & Psychiatry*, 75(3), 481-484. doi:10.1136/jnnp.2003.021873

Zweig, R. et al. (1993). The locus ceruleus and dementia in Parkinson's disease. *Neurology*, 43(5), 986-991.



## Automation of functional annotation of genomes and transcriptomes

### Automatización de la anotación funcional de genomas y transcriptomas

Luis Fernando Cadavid Gutiérrez\*, José Nelson Pérez Castillo\*\*, Cristian Alejandro Rojas Quintero\*\*\*, Nelson Enrique Vera Parra\*\*\*\*

**Fecha de recepción:** June 10th, 2014

**Fecha de aceptación:** November 4th, 2014

**Citation / Para citar este artículo:** Cadavid Gutiérrez, L. F., Pérez Castillo, N. J., Rojas Quintero, C. A., & Vera Parra, N. E. (2014). Automation of functional annotation of genomes and transcriptomes. *Revista Tecnura*, 18 (Edición especial doctorado), 90–96. doi: 10.14483/udistrital.jour.tecnura.2014.DSE1.a08

#### ABSTRACT

Functional annotation represents a way to investigate and classify genes and transcripts according to their function within a given organism.

This paper presents Massive Automatic Functional Annotation (MAFA - Web), which is an online free bioinformatics tool that allows automation, unification and optimization of functional annotation processes when dealing with large volumes of sequences. MAFA includes tools for categorization and statistical analysis of associations between sequences. We have evaluated the performance of MAFA with a set of data taken from *Diploria-Strigosa* transcriptome (using an 8-core computer, namely E7450 @ 2,40GHZ with 256GB RAM), processing rates of 2,7 seconds per sequence (using Uniprot database) and 50,0 seconds per sequence (using Non-redundant from NCBI database) were found together with particular RAM usage patterns that depend on the

database being processed (1GB for Uniprot database and 9GB for Non-redundant database). Availability: <https://github.com/BioinfUD/MAFA>.

**Keywords:** Annotator, Functional annotation, Gene ontology, High Throughput Sequencing.

#### RESUMEN

La anotación funcional es un medio para investigar y clasificar genes y transcritos de acuerdo con la función que realizan en un organismo dado.

Este artículo presenta Massive Automatic Functional Annotation (MAFA - Web), la cual es una herramienta bioinformática libre y en línea que permite la automatización, unificación y automatización de los procesos de la anotación funcional, trabajando con grandes volúmenes de secuencias. MAFA incluye herramientas para la categorización y análisis estadístico de las asociaciones entre secuencias y su ontología correspondiente. Se ha evaluado el

\* Medicine Doctor, Ecology and Evolutionary Biology PhD., IEI Research Group - Teacher / Researcher, Institute of Genetics and Department of Biology, National University, Bogotá D.C., Colombia. [lfcadavidg@unal.edu.co](mailto:lfcadavidg@unal.edu.co)

\*\* System Engineer, Informatics PhD., GICOG Research Group - Director of Center for Scientific Research and Development, Universidad Distrital Francisco José de Caldas, Bogotá D.C., Colombia. [nelsonp@udistrital.edu.co](mailto:nelsonp@udistrital.edu.co)

\*\*\* System Engineer Student, GICOG Research Group - Student, Universidad Distrital Francisco José de Caldas, Bogotá D.C., Colombia. [caro-jasq@correo.udistrital.edu.co](mailto:caro-jasq@correo.udistrital.edu.co)

\*\*\*\* Electronic Engineer, Information Sciences and Communication M.Sc., GICOG Research Group - Teacher / Researcher, Universidad Distrital Francisco José de Caldas, Bogotá D.C., Colombia. [neverap@udistrital.edu.co](mailto:neverap@udistrital.edu.co)

desempeño de MAFA con un set de datos tomado del transcriptoma de *Diploria-Strigosa* (usando un computador de 8 núcleos, específicamente un E7450 @ 2,40GHZ con 256GB de memoria RAM). Se encontraron tasas de procesamiento de 2,7 segundos por secuencia (usando la base de datos de Uniprot) y 50,0 segundos por secuencia (usando la base de datos Non-redundant de NCBI), junto con

un patrón particular de uso de RAM que depende de la base de datos que es procesada (1GB para la base de datos Uniprot y 9GB para la base de datos Non-redundant). Disponibilidad: <https://github.com/BioinfUD/MAFA>.

**Palabras clave:** anotador, anotación funcional, ontología génica, secuenciación de alto rendimiento.

## INTRODUCTION

Biological-sequence decoding plays an essential role in almost all research branches of Biology. For various decades, sequencing processes were conducted using the Sanger method (including the human genome project, where this method was crucial). However, the cost of the method and its limitations in terms of performance, scalability, speed and resolution have led to a migration trend towards using new procedures in the last 5 years, namely the so called “next generation sequencing” (Mekster, 2010; Martin & Wang, 2011) These new technologies allow having lower-cost, more-efficient sequencing, which leads to an exponential growth in the volumes of sequenced data.

Optimization of the sequencing process would be worthless without the development and optimization of suitable computing tools capable of analyzing such large sequenced-data volumes. In this context, one of the main needs of genomic-transcriptomic data mining is functional annotation. As a process, functional annotation consists of two stages, namely a search for known similar sequences (through alignment) and the association of such sequences to functional categories. The type of tools that are commonly used to carry out functional annotation processes are the following: BLAST - Basic Local Alignment Search Tool (Altschul *et al.*, 1990), (Camacho *et al.*, 2008) (for finding sequences through alignment) and GO - Gene Ontology (Ashburner *et al.*, 2000) (which provides

controlled-term vocabulary to describe particular genes and the gene-product attributes within a particular organism).

The annotation process for unknown sequences involves the use and integration of various tools that deal with the following tasks: Local-alignment search for comparing unknown sequences with known-sequence databases (e.g. Swissprot, Uniprot, Refseq, among others), association between sequences and the ontology that describes the functionality of such sequences and categorization and statistical analysis of the corresponding associations).

This paper is divided in two sections. In the first section we describe the software working way. In the second section we have made an evaluation of MAFA using various datasets.

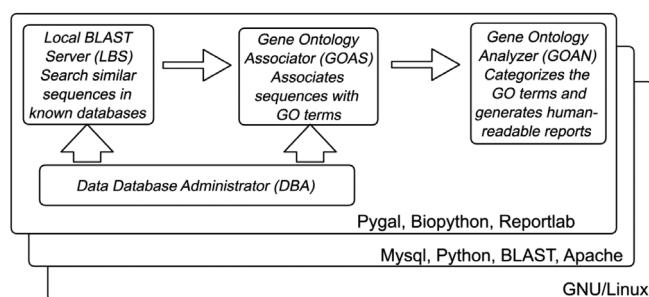
## METHODOLOGY

### General description

MAFA is a free online bioinformatics tool that has been optimized to carry out functional annotation processes over large numbers of nucleotide sequences (genomes and transcriptomes). Moreover, MAFA includes additional tools to perform categorization and statistical analysis of the corresponding sequence-ontology associations. MAFA is intended to operate by a web interface making the functional annotation a simple process (almost intuitive) for biologist.

## Architecture

MAFA consists of 4 modules that constitute a work flow. In order to run and integrate the modules, it is necessary to use additional tools that apply to all modules. Figure 1 shows the 4 modules together with the work flow and the cross-module applicable tools.



**Figure 1.** Workflow for MAFA

**Source:** Own work.

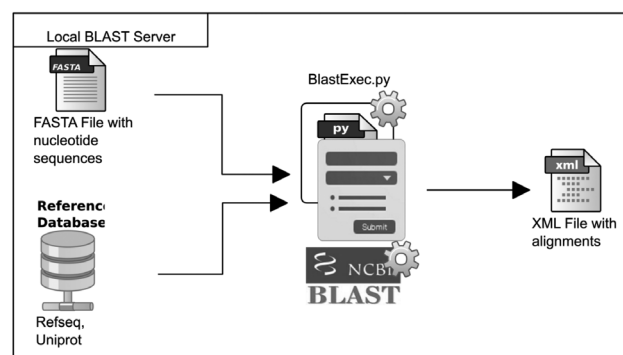
### Cross-module software components

**MySQL:** A relational and multi-thread, multi-user data-base management system, also free software. **GNU/Linux:** A free operating system that is suitable for servers and also for running bio-informatics tools. **Biopython** (Cock *et al.*, 2009): has proposed this free software project with various modules intended to facilitate manipulation of bioinformatics data. **Pygal:** Free libraries that assist the production of graphical materials for the representation of information. **BLAST** (Basic Search Alignment Tool): A tool intended to find local regions of similarity through sequence alignment. **Reportlab:** A open-source Python-based library that facilitates the creation of PDF-format files. **Apache:** A HTTP server with free license.

### Local BLAST server

This module is in charge of running BLAST (Nucleotides vs Amino-acids) and also of storing the corresponding output using the XML format. Figure 2 shows the inputs and outputs of this module. The script involved in this module is as follows:

*BlastExec.py:* This script orders the system to run blastx (Sequences against Reference database) using various cores.

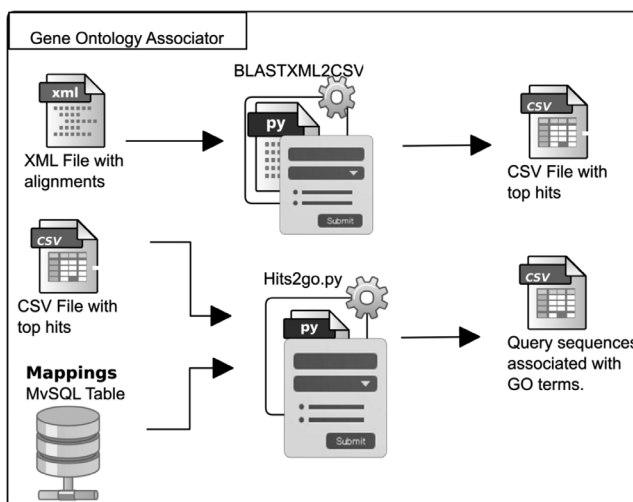


**Figure 2.** LBS-module Diagram

**Source:** Own work.

### GO associator

This module establishes the existing associations between the best hits, obtained from BLAST, and the terms from Gene Ontology. These associations are made by means of mapping tables between sequence identifiers and GO terms. The GOAS module is shown in Figure 3.



**Figure 3.** GOAS-module diagram

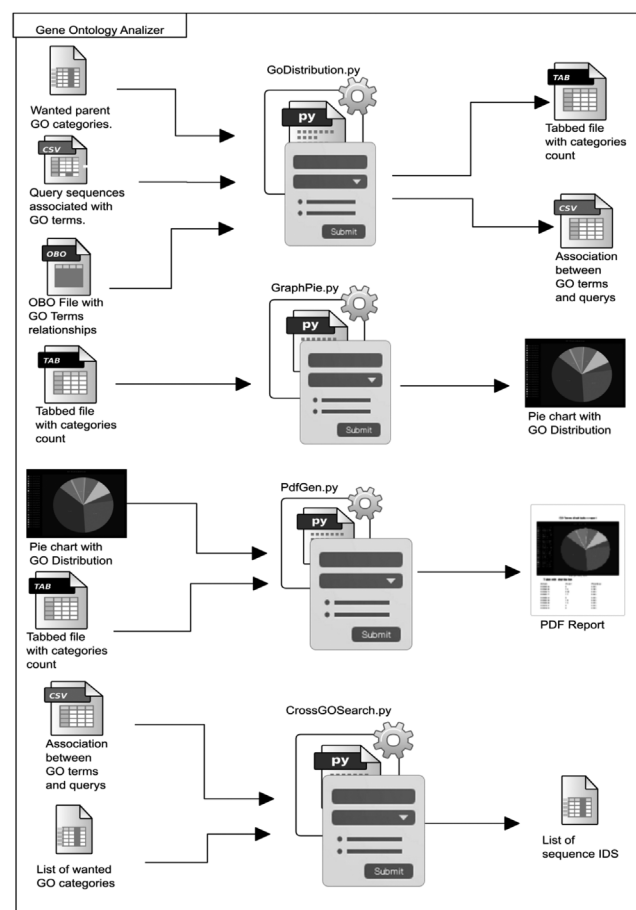
**Source:** Own work.

This module involves the following scripts:  
*BLASTXML2CSV.py:* This script selects the best alignment per sequence (top hit) and also writes

the new file in CSV format outputting the id from the query sequence associated with the id of the subject sequence with the best alignment score.

*Hits2go.py*: This script makes an association between sequence identifiers and GO terms using the mappings table provided by the Georgetown University.

### GO analyzer



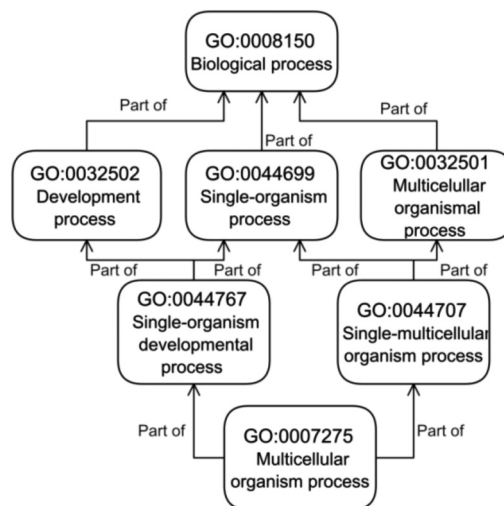
**Figure 4.** GOAN-module Diagram

Source: Own work.

This module categorizes the GO terms according to user's interests. The module also counts how many times particular input sequences appear into the per-user categories and produces a complete report of the results. Additionally, the module is capable of finding sequences that belong to more than one GO category. Figure 4 shows the internal

components of this module. The scripts involved in this module are as follows:

*GoDistribution.py*: This script associates the desired GO categories (desired by users) to the more abstract GO terms; it also counts how many times input sequences appear per desired GO category. This process is done using the relationship of each GO term with the corresponding parents terms, these relationships has been downloaded previously using AmiGO browser which has been proposed and developed by Carbon *et al.* (2009). In figure 5 we presented an example explaining how the more specific GO term is associated with a more abstract term. In this case "Multicellular organism process" will be associated with "Development process", "single-organism process" and "Multicellular organismal process" categories.



**Figure 5.** Example of GO association process

Source: Own work.

*GraphPie.py*: This script produces a circular graph that illustrates the distribution of the categories given by the previous analysis.

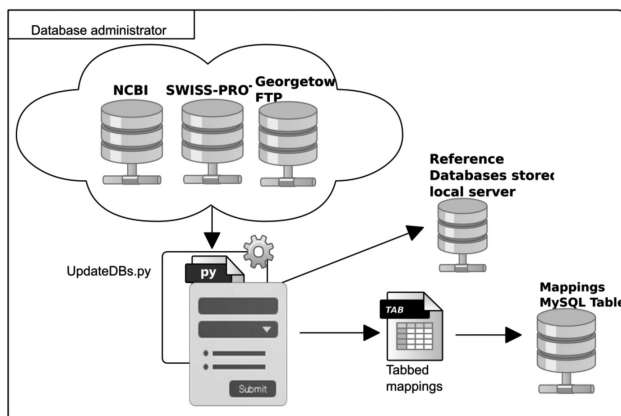
*CrossGOsearch.py*: This script is useful to filter all the sequences that appear in various GO categories at the same time, giving to the user the possibility to study a gene that can be involved in various functions at the same time.



*PdfGen.py*: This script produces a human-readable PDF report that contains the analysis results, this report includes a table with the counts of the GO categories and with the pie chart of the distribution making this software a user-friendly tool.

### Database administrator

This module carries out updating tasks over the databases of both sequences and mapping so that the databases are available in the local server. This module is presented in figure 6.



**Figure 6.** DBA-module Diagram

**Source:** Own work.

The elements involved in this module are as follows:

*UpdateDBs.py*: Processes: a first process connects to servers NCBI and Swisprot in order to download the databases; another process generates the indices of downloaded files for BLAST, a third process connects to the FTP at Georgetown University in order to download a file that maps the various types of identifiers onto GO terms. This script also executes *MappingstoDB.py* script which stores the corresponding mapping file in a MySQL table so as to provide quick access.

## EVALUATION

### Dataset

We have selected a transcriptome FASTA file from *Hydractinia Symbiolongicarpus*; from the

transcriptome we have selected 500, 1000, 2000, 4000 sequences randomly to do the analysis against RefSeq Non-Redundant (Pruitt *et al.*, 2007) and Uniprot (Bairoch *et al.*, (2005) protein databases, both update at May 2014; the expected value selected for the BLAST algorithm is  $1e-3$ .

This transcriptome was selected because it is a representative and typical example of the data normally required to annotate by the researchers from Evolutionary Immunology and Immunogenetics Group from Genetics Institute of Universidad Nacional de Colombia, which are researching for immune response of coral organisms and disappearance of reefs (MAFA was developed in the framework of this research).

### Configuration

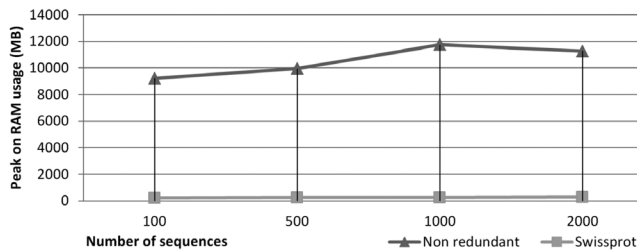
Processing Cores: 8 out of 24 from a Xeon E7450 @ 2,40GHz

Available RAM: 256GB

## RESULTS

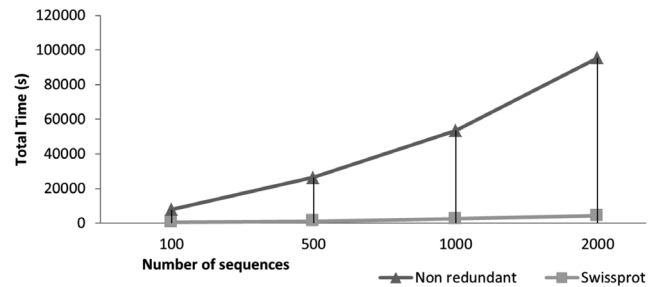
Figure 7, figure 8 and table 1 indicate that the module requiring longer processing times is Local Blast Server. Additionally, it can be observed that the relation between processing time and the number of sequences is almost linear, reaching database-dependent rates of 2,7 seconds per processed sequences (for Uniprot) and 50 seconds per processed sequence (for Non-redundant).

Regarding RAM usage, there is direct dependency on the database in use; on the other hand, there is no dependency on the number of sequences to be processed. For Uniprot, RAM usage is approximately 300MB, for Non-redundant, RAM usage is 11GB.



**Figure 7.** Performance results (Execution time)

Source: Own work.



**Figure 8.** Performance results (Execution time)

Source: Own work.

**Table 1.** MAFA Performance analysis results

Databases	Number of sequences	Module				
		LBS	GOAS	GOAN	TOTAL	
		Time (S) (MB)	Time (S)	Time (S)	Peak RAM	Time (S)
Uniprot	Original					
	100	459	5	1	230	465
	1000	2451	32	12	250	2495
	2000	4374	68	23	270	4465
Refseq	4000	7691	126	20	354	7837
	100	7059	201	17	9000	7277
	500	24571	629	78	9700	25278
	1000	49579	1353	178	11500	51110
	2000	90678	1986	303	11000	91167

Source: Own work.

## CONCLUSIONS

MAFA is a tool that allows functional annotation and further annotation classification provided there are some given term-specific categories of Gene Ontology. MAFA's main functions include the following: the generation of structured-data outputs that advertise the amount of sequences associated to each GO term, and the establishment of relations between the target term identifiers of Gene Ontology and the identifiers of the given sequences. Additionally, MAFA generates easy-to-interpret graphs for users as well as complete PDF reports containing the results from the corresponding analysis. It

is also possible to conduct search processes in order to find sequences that are simultaneously associated to various categories or GO terms.

## FUNDING

Center for Scientific Research and Development – Universidad Distrital Francisco José de Caldas.

## ACKNOWLEDGEMENTS

Work done in collaboration with High Performance Computational Center (CECAD) – Universidad Distrital Francisco José de Caldas, Bogotá D.C.,

Colombia (<http://cecad.udistrital.edu.co>) and Evolutionary Immunology and Immunogenetics Group (<http://www.genetica.unal.edu.co/gie/>) - Genetics Institute – Universidad Nacional (IGUN), Colombia, (<http://www.genetica.unal.edu.co>).

## REFERENCES

- Altschul, S. F. et al. (1990). Basic local alignment search tool. *Journal of molecular biology*, 215(3), 403-410.
- Ashburner, M. et al. (2000). Gene Ontology: Tool for the unification of biology. *Nature genetics*, 25(1), 25-29.
- Bairoch, A. et al. (2005). The universal protein resource (UniProt). *Nucleic acids research*, 33(1), D154-D159.
- Camacho, C. et al. (2009). BLAST+: Architecture and applications. *BMC bioinformatics*, 10(1), 421.
- Carbon, S. et al. (2009). AmiGO: Online access to ontology and annotation data. *Bioinformatics*, 25(2), 288-289.
- Cock, P. J. et al. (2009). Biopython: Freely available Python tools for computational molecular biology and bioinformatics. *Bioinformatics*, 25(11), 1422-1423.
- Metzker, M. L. (2010). Sequencing technologies—the next generation. *Nature Reviews Genetics*, 11(1), 31-46.
- Pruitt, K. D., Tatusova, T., & Maglott, D. R. (2007). NCBI reference sequences (RefSeq): A curated non-redundant sequence database of genomes, transcripts and proteins. *Nucleic acids research*, 35(1), D61-D65.

## Mechanical resistance of a chemically-modified warm mix asphalt

### Resistencia mecánica de una mezcla asfáltica modificada con un aditivo químico

Hugo Alexander Rondón Quintana\*, Wilmar Darío Fernández Gómez\*\*

**Fecha de recepción:** June 10th, 2014

**Fecha de aceptación:** November 4th, 2014

**Citation / Para citar este artículo:** Rondón Quintana, H. A., & Fernández Gómez, W. D. (2014). Mechanical resistance of a chemically-modified warm mix asphalt. *Revista Tecnura*, 18 (Edición especial doctorado), 97–108. doi: 10.14483/udistrital.jour.tecnura.2014.DSE1.a09

#### ABSTRACT

Warm Mix Asphalt (WMA) technology offers a wide range of potential for use in road construction projects. Although the main advantage of using WMA mixtures is environmental, there are also noteworthy technical and economic benefits. This paper discusses results for the laboratory evaluation of WMA mixtures and their subsequent comparison to traditional hot mix asphalts (HMA). WMA and HMA mixtures of nominal maximum aggregate size of 25 mm were employed in this study. The WMAs were obtained by means of a liquid chemical solution that foams the asphalt binder AC 60-70 (PG 58-22). Aspects studied include strength under monotonic and dynamic loading. Additionally, a battery of tests was performed: Marshall, resilient modulus, permanent deformation and indirect tensile strength. The research herein leads to the conclusion that the WMA chemical additive decreases mix temperatures by 30° C, which, in turn, translates into better mixture workability and volumetric composition. Furthermore,

WMAs display higher levels of resistance to high service temperatures under monotonic and dynamic loading.

**Keywords:** chemical additive, foamed asphalt, hot mix asphalt, mechanical behavior, warm mix asphalt.

#### RESUMEN

La tecnología de las mezclas asfálticas tibias (WMA por sus siglas en inglés) brinda una amplia oportunidad de éxito en la construcción de capas asfálticas para carreteras. Su principal ventaja es de carácter ambiental, aunque también ofrece ventajas técnicas y económicas. El artículo presenta los resultados experimentales de un estudio ejecutado con el fin de evaluar la resistencia mecánica de una mezcla asfáltica tibia, fabricada empleando un aditivo químico líquido que espuma el asfalto. Para tal fin, se evaluó sobre la mezcla la resistencia bajo carga monotónica empleando el ensayo Marshall y el de tracción indirecta, el cambio en la composición volumétrica, la rigidez bajo carga cíclica y la resistencia a la

\* Civil Engineer, Masters in Civil Engineering and Doctorate in Engineering, Faculty of the Environment and Natural Resources, Universidad Distrital Francisco José de Caldas. Bogotá D.C., Colombia. [harondonq@udistrital.edu.co](mailto:harondonq@udistrital.edu.co)

\*\* Civil Engineer, Masters in Civil Engineering and Doctorate in Engineering, Faculty of the Environment and Natural Resources, Universidad Distrital Francisco José de Caldas. Bogotá D.C., Colombia. [wfernandez@udistrital.edu.co](mailto:wfernandez@udistrital.edu.co)

deformación permanente. Como granulometría de referencia se utilizó la de la mezcla densa en caliente MDC-25 (INVIAS, 2013) y como ligante, cemento asfáltico tipo CA 60-70. En conclusión, se reporta que el aditivo empleado es capaz de reducir la temperatura de la mezcla asfáltica en caliente de referencia MDC-25 en 30°C, generando una mezcla tibia con

composición volumétrica similar y de mayor rigidez y resistencia bajo carga monotónica y cíclica.

**Palabras clave:** aditivo químico, asfalto espumado, mezcla asfáltica en caliente, mezcla asfáltica tibia, resistencia mecánica.

---

## INTRODUCTION

The four main categories used to describe asphalt mixtures are based on the temperatures used for their production in specialized asphalt plants: cold mix asphalt – CMA (temperatures lower than 60°C), half-warm mix asphalt – HWMA (temperatures between 60°C and 100°C), warm mix asphalt – WMA (temperatures between 100°C and 140°C) and hot mix asphalt - HMA (temperatures between 140°C and 190°C) (Rubio, Martínez, Baena & Moreno, 2012; Rondón & Reyes, 2014). WMA mixtures, achieved using a variety of techniques, can reduce mixing and compaction temperatures required for HMAs without significantly altering mechanical properties. According to Bonaquist (2011) and Sterling (2012), the minimum decrease in the mixture manufacturing temperature in an asphalt plant must be 28°C (compared to an HMA) for a mixture to be designated as WMA. The reduced mixing and compaction temperatures is accompanied by a decrease in the energy required for mixture production and a decrease in atmospheric emissions (Romier, Audeon, David, & Martineau, 2006; Kristjansdottir, Muench, Michael & Burke, 2007; (Wasiuddin, Selvamohan, Zaman, & Guegan, 2007; Biro, Gandhi, & Amirkhanian, 2009; Tao & Mallick, 2009a; Bonaquist, 2011). According to You & Goh (2008), WMA mixtures generate less pollutant emissions during manufacture and construction processes regarding the HMA mixtures; energy savings approach 30%.

Using a life-cycle assessment (LCA) model (Blankendaal, Schuur, & Voordijk, 2014), report WMA

mixtures represent a 33% less negative environmental versus HMA mixtures. Prowell, Frank, Osborne, Kriech, & West (2014) and West, Rodezno, Julian, & Prowell (2014) reported an average reduction in mix temperature of 27°C for WMAs, which lead to average fuel savings of 22,1%. According to Robjant & Dosh (2009), this fuel reduction can be placed between 20% and 35%, but, sometimes, reaches 50% or greater. Estakhri, Cao, Álvarez, & Button (2009) further explain the benefits of WMAs, this time turning to significant reductions in CO<sub>2</sub>, SO<sub>2</sub>, volatile organic compounds, CO, NO<sub>x</sub> and ash; reduction levels are 30%-40%, 35%, 50%, 10%-30%, 60%-70% and 20%-25%, respectively, compared to these levels for HMA mixtures.

Based on Building for Environmental and Economic Sustainability model (BEES 4.0), Hassan (2010) found that, in comparison to HMA mixtures, WMA mixtures generate 24%, 18%, and 15% less air pollution, fossil fuel consumption and total negative environmental impact, respectively. During road construction processes that rely on WMA mixtures, worker exposing to breathable fumes is significantly reduced, thus directly improving worker health and safety as well as the environment (Prowell et al., 2014; West, Rodezno & Prowell, 2014).

From the perspective of aging, lower oxidation levels are exhibited for the short-term aging of asphalt binders is generally reported, a product of the lower temperatures used during the manufacture, extension and compaction processes of the WMA mixture; this may result in increased resistance to fatigue, low-temperature top-down cracking (TDC)



and oxidation (Zhao, Xiao, Amirkhani, & Putman, 2012; Goh, Hasan & You, 2013; Hossain & Zaman, 2013; Vidal, Moliner, Martínez & Rubio, 2013).

A number of studies, carried out both in situ and in the laboratory, provide evidence that WMA mixtures exhibit properties comparable—and even superior—to those of HMA mixtures (Kim, Zhang & Ban, 2012; Tan, Guo, Xu & Zhang, 2012; Zhao, Xiao, Amirkhani & Putman, 2012; Behl, Kumar, Sharma & Jain, 2013; Topal et al., 2014). Regarding mixture use in construction, it has been consistently noted that the viscosity of the asphalt binder used to manufacture WMA mixtures is lower than that of the binder used for HMA mixtures (You & Goh, 2008), which results in an earlier road inaugurations and improved workability (Vasconcelos, Bhasin & Little, 2010; Capitão, Picado-Santos & Martinho, 2012; Wang et al., 2013; Goh, Hasan & You, 2013). What is more, the additives employed to develop WMAs allow for longer mixture transport distances prior to extension and compaction (Robjant & Dosh, 2009) and allow extension and compaction to be performed in colder environments (Tao, Huang, Du & Yan, 2009). As a result of these factors, WMA technology is deployed to manufacture emergency roads in regions subject to natural disasters (Howard et al. 2014).

Another widely reported advantage of WMA technology comes in the form of recycling; that is, the production of recycled mixtures, recycled or reclaimed asphalt pavement (RAP) (Morea, Marcozzi & Castaño, 2012; Wu & Zeng, 2012; Doyle & Howard, 2013; Rossi et al., 2013; Hajj, Souli-man & Cortez, 2014; Nejad, Azarhoosh, Hamedi & Roshani, 2014; Yu, Leng & Wei, 2014; West, Rodezno, Julian & Prowell, 2014) Researchers such as (Ameri, Hesami & Goli, 2013) discuss using technology to produce WMA mixtures with comparable, or even superior, properties to those of HMA when the natural stone aggregate is replaced by ground-granulated blast-furnace slag (GGBS). For a state of the art on WMA technology, readers are directed to (Rondón & Reyes, 2015).

The WMA under study in the present paper was made with a liquid chemical additive used to foam the asphalt binder. The additive was introduced during the mixture of asphalt binder AC 60-70 (ac-cording to the ASTM D-5 penetration test) with a performance grade (PG) 58-22. To properly assess WMA performance, the gradation of a HMA was used as a sort of control (HMA-25). The number attached to the HMA represents the nominal maxi-mum aggregate sizes of 25 mm, in line with the specifications found in (INVIAS, 2013). Marshall, resilient modulus, permanent deformation and in-direct tensile strength (ITS) tests were conducted to evaluate strength under monotonic and dynam-ic loading, in addition to resistance to moisture damage.

## METHODOLOGY

### Materials

**Table 1.** Characterization of aggregate and asphalt binder

Test	Method	Result
Specific Gravity (Coarse and Fine)	ASTM D 854-00	2,62
Sand Equivalent Value	ASTM D 2419-95	76%
Liquid Limit, Plastic Limit	ASTM D 4318-00	0%
Plasticity Index	ASTM D 4318-00	0%
Fractured Particles	ASTM D 5821-01	87%
Shape – Flat Indices	NLT 354-91	9,5%
Soundness of Aggregates Using Magnesium Sulfate	ASTM C 88-99a	12,9%
Abrasion in the Micro-Deval Apparatus	ASTM D6928-03	22,3%
10% of Fines (Wet/Dry Ratio)	DNER-ME 096-98	83%
Abrasion in Los Angeles Machine	ASTM C 131-01	24,6%

**Source:** Own work.

**Table 2.** Aggregate Gradation for Asphalt Mixtures

SIEVE HMA-25		PERCENT PASSING
25,0 mm	1"	100
19,0 mm	3/4"	87,5
12,5 mm	1/2"	76
9,5 mm	3/8"	68,5
4,75 mm	No. 4	51
2,00 mm	No. 10	37
0,425 mm	No. 40	19,5
0,180 mm	No. 80	12,5
0,075 mm	No. 200	6

Source: Own work.

**Table 3.** AC 60-70 Characteristics

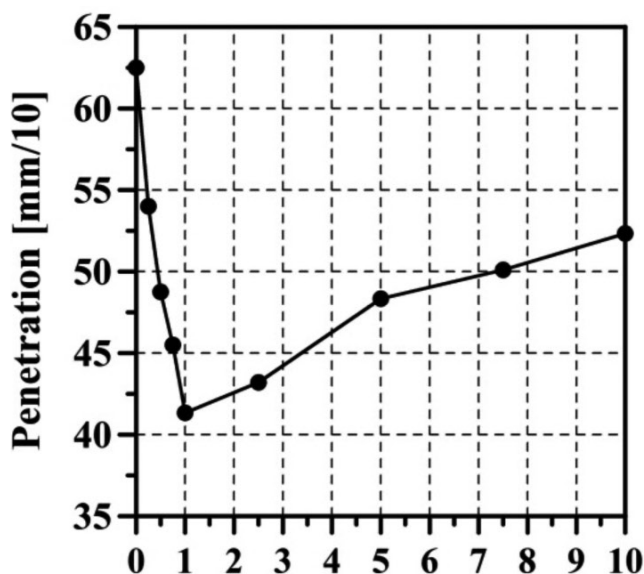
Test	Method	Unit	AC 60-70
Neat Asphalt			
Penetration (25° C, 100 g, 5 s)	ASTM D-5	0,1 mm	65
Penetration Index	NLT 181/88	-	-0,7
Softening Point	ASTM D-36-95	° C	52,5
Absolute Viscosity (60°C)	ASTM D-4402	Poises	1752
Viscosity at 135°C	AASHTO T-316	Pa-s	0,36
Specific Gravity	AASHTO T 228-04	-	1,016
Ductility (25°C, 5cm/min)	ASTM D-113	cm	>105
Solubility in Trichloroethylene	ASTM D-2042	%	>99
Water Content	ASTM D-95	%	<0,2
Flashpoint	ASTM D-92	°C	275
Tests on Residue after RTFOT			
Mass Loss	ASTM D-2872	%	0,47
Penetration of Residue after Loss by Heating, in % of Original Penetration	ASTM D-5	%	72

Source: Own work.

Aggregate properties are given in table 1, and table 2 provides data related to the gradation used in asphalt mixture fabrication. For results of

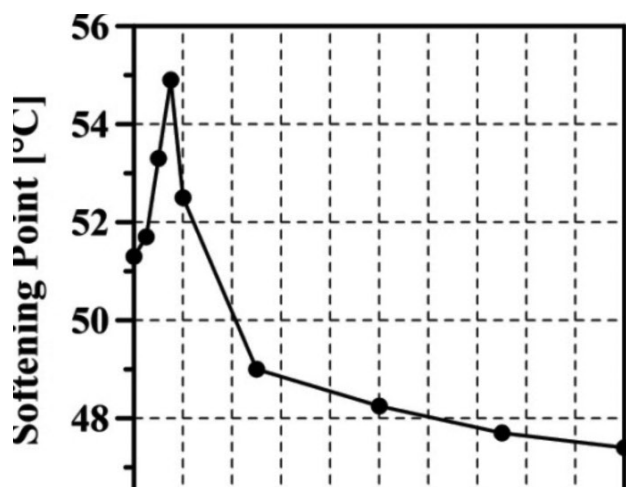
characterization tests performed on the AC 60-70 asphalt binder, see table 3. In the tables, readers will find the acronyms RTFOT and PAV, which refer, respectively, to the Rolling Thin Film Oven Test and Pressure Aging Vessel. The former simulates short-term aging, while the combination of the two simulates long-term aging.

Although the actual name and properties of the additive are not mentioned here due to a pending technological development, select properties of AC 60-70 modified with the additive are displayed in figures 1 and 2. The additive, a liquid chemical product used to foam the binder (dubbed HUSIL by the authors), is not classified as dangerous or as a pollutant according to the Globally Harmonized System of Classification and Labelling of Chemicals - GHS (United Nations Economic Commissions for Europe - UNECE, 2013). An inorganic material that does not ignite, HUSIL's pH value ranges between 10 and 12. Furthermore, it is not considered carcinogenic or teratogenic. As for HUSIL's use as an additive, it was mixed/combined with AC 60-70 at 80°C for 5 minutes; 80°C was chosen on account of the fact that this temperature represents that at which the additive foams the bitumen.



**Figure 1.** Evolution of the Penetration (ASTM D-5, 25° C, 100 g, 5 s) with HUSIL/AC

Source: Own work.



**Figure 2.** Evolution of the Softening Point (ASTM D-36-95) with HUSIL/AC

Source: Own work.

Figures 1 and 2 illustrate a noticeable increase in stiffness after 1% HUSIL is added (in relation to the binder's total mass). With increased stiffness comes an increased softening point and decreased penetration, results consistent with the rheological characterization at high and intermediate service temperatures using a dynamic shear rheometer

- DSR (AASHTO T 315-05). Tables 4 and 5 depict rheological characteristics of AC 60-70 asphalt binder without additive (HUSIL/AC = 0%) and modified with HUSIL/AC = 1%, respectively. In these tables,  $G^*$  and  $\delta$  denote the shear modulus complex and phase angle, respectively. PG at high and intermediate service temperatures of AC 60-70 was 58°C ( $|G^*|/\sin \delta > 1,0$  kPa for un-aged asphalt binder and  $|G^*|/\sin \delta > 2,2$  kPa for RTOT-aged asphalt) and 22°C ( $|G^*|/\sin \delta < 5000$  kPa for RTFOT + PAV-aged asphalt), respectively.

Modified asphalt binder (HUSIL/AC = 1%) exhibits better PG at high service temperatures (70°C), which helps bolster resistance to permanent deformation in high-temperature climates. In the same vein, it becomes apparent that PG at intermediate service temperatures improves when HUSIL/AC = 1% (19° C). This is most likely attributable to the improved resistance to aging HUSIL offers the bitumen. On a side note, rheological characterization tests at low service temperatures were not conducted, for the present research focused on application in tropical countries, such as Colombia.

**Table 4.** AC 60-70 Rheological Characterization without Additive (HUSIL/AC=0%)

Temperature [°C]	Frequency [rad/s]	$\delta$ [°]	$G^*$ [Pa]	$ G^* /\sin \delta$ [kPa]	$ G^*  \cdot \sin \delta$ [kPa]
AC 60-70 not aged – Neat asphalt					
58	10	87	2470	2,473	2,467
64	10	88	1002	100	1,00
70	10	89	453	0,453	0,453
AC 60-70 aged in RTFOT					
52	10	83	11062	11,15	10,98
58	10	85	4276	4,29	4,26
64	10	87	1701	1,70	1,70
AC 60-70 aged in RTFOT + PAV					
16	10	44	14266000	20537	9910
19	10	45	10193000	14415	7208
22	10	47	6659000	9105	4870

Source: Own work.

**Table 5.** Rheological Characterization of Modified AC 60-70 (HUSIL/AC=1%)

Temperature [°C]	Frequency [rad/s]	$\delta$ [°]	$G^*$ [Pa]	$ G^* /\sin\delta$ [kPa]	$ G^*  \cdot \sin\delta$ [kPa]
AC 60-70 modified with HUSIL/AC=1%, not aged					
64	10	66,5	2358,3	2,57	2,16
70	10	69	1280,5	1,37	1,20
76	10	70	888,2	0,95	0,83
AC 60-70 modified with HUSIL/AC=1%, aged in RTFOT					
64	10	72,4	8685	9,11	8,28
70	10	76,3	4072	4,19	3,96
76	10	79,8	1899	1,93	1,87
AC 60-70 modified with HUSIL/AC=1%, aged in RTFOT + PAV					
16	10	31,5	11700000	22392	6113
19	10	32,6	8570000	15907	4617
22	10	33,9	6150000	11027	3430

Source: Own work.

## Control HMA design

After performing preliminary tests on the aggregate and asphalt binders, five briquettes were made (compacted at 75 blows per side using a standard Marshall hammer) with asphalt binder percentages of 4,5%, 5,0%, 5,5%, 6,0% and 6,5% in order to carry out the Marshall mix design procedure (AASHTO T 245-97, 04) on the control HMA (HMA-25 without additive, HUSIL/AC = 0%). Laboratory mix and compaction temperatures were set at 140°C and 150°C, respectively; these values were selected based on the criteria established by ASTM D6925, wherein the viscosities required to obtain mix and compaction temperatures for dense-graded HMAs are  $85 \pm 15$  SSF (170 cP) and  $140 \pm 15$  SSF (280 cP), respectively.

Optimum asphalt percentage was determined to be 5,3% for HMA-25. This percentage was established by looking at the average values for the following four asphalt contents: (1) asphalt binder content corresponding to maximum stability and flow (S/F) ratio; (2) asphalt binder content

corresponding to maximum bulk specific gravity; (3) flow values between 2 and 3,5 mm; (4) asphalt binder content corresponding to designed air void percentage boundaries in the total mixture (between 3% and 6%). Bulk specific gravities and air void contents were measured in accordance with ASTM D2726.

## Experimental testing program

After arriving at the optimum asphalt content, modified (HUSIL/AC = 1%, 2%, 3%) and unmodified (HUSIL/AC = 0%) HMA-25 specimens were prepared at mix temperatures (T) of 140°C, 130°C, 120°C and 110°C. Five briquettes were made (compacted at 75 blows per side using a standard Marshall hammer) for each HUSIL/AC ratio and T. The previously mentioned briquettes help account for a handful of variables: mix temperature, HUSIL/AC ratio and HMA type. Likewise, they allowed researchers to conduct the Marshall tests. Procedurally speaking, the additive was combined with the asphalt binder (AC 60-70) during aggregate and bitumen mixing.



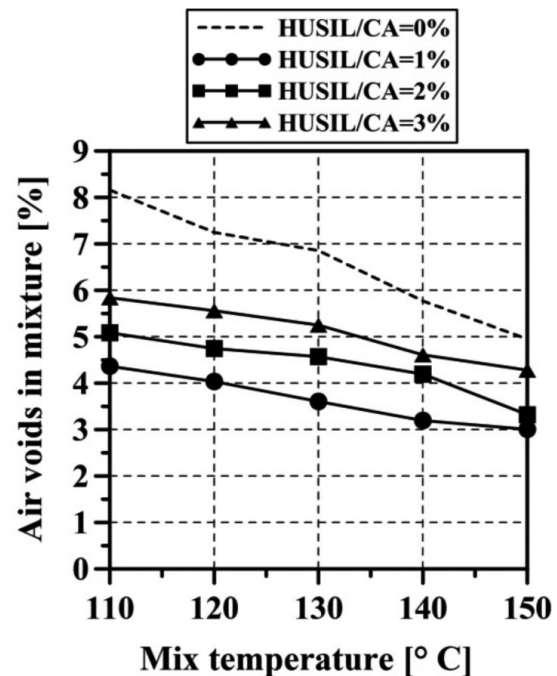
The HMA control mixture (without additive, HMA-25, HUSIL/AC = 0%, T = 150°C) and the WMA mixture (with additive, WMA-25, HUSIL/AC = 1%, T = 120°C) were analyzed using resilient modulus tests (ASTM D 4123-82) at three different temperatures (5°C, 15°C and 40°C) and loading frequencies (2,5 Hz, 5 Hz and 10 Hz). Thus, stiffness under dynamic loading could be assessed. Together, the mixing temperature (120°C) and ratio HUSIL/AC = 1% for WMA were chosen with an eye towards decreasing the temperature needed for HMA by 30°, as well as taking modified asphalt binder characteristics and Marshall test results into account. In addition, permanent deformation tests (Spanish NLT-173-00 regulation) were performed at 60°C with a contact pressure of 900 kPa. Both tests were run on the control HMA (HUSIL/AC = 0%, T = 150°C) and the WMA (HUSIL/AC = 1%, T = 120°C). Each resilient modulus test was carried out on nine samples (three for each temperature), while the permanent deformation tests were done on a total of three samples.

ITS (ASTM D 4867/D4867M-96) was tested to evaluate resistance under monotonic loading for the HMA (HUSIL/AC = 0%, T = 150°C) and WMA (HUSIL/AC = 1%, T = 120°C). Furthermore, ITS testing helped determine resistance to moisture damage by measuring wet/dry tensile shear ratios (TSR) expressed as percentages. Six samples for each HMA and WMA with air void percentages of  $7 \pm 1\%$  were tested (12 samples in total). Of the six samples for each mixture, three were tested in a dry state and three in a wet state (the target degree of saturation was 75–80%).

## RESULTS AND DATA ANALYSIS

Data related to air voids and the Marshall S/F ratio (Marshall Quotient – MQ in kg/mm) are shown in Figures 3 and 4. Figure 3 provides evidence of a typical increase in air voids inversely related to mix temperature; an inverse relationship of this nature often indicates diminished workability (i.e. greater

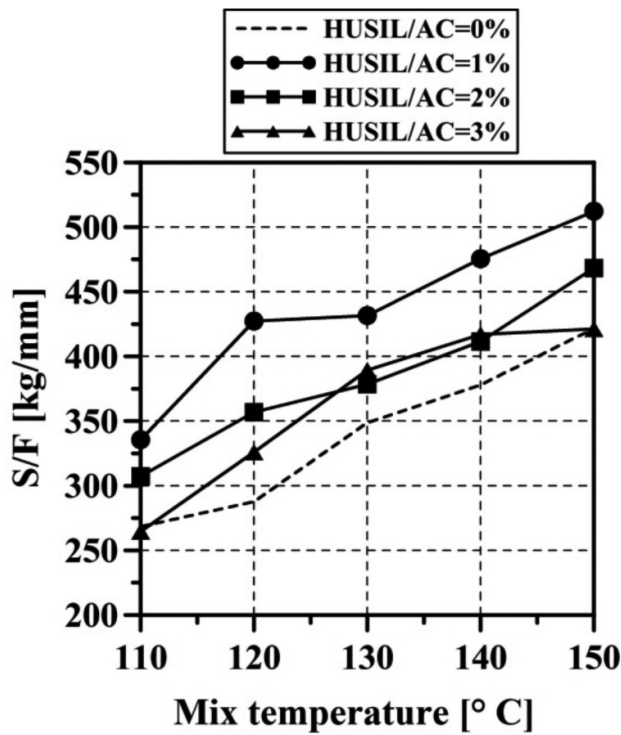
difficulty to compact mixtures) brought about by increased binder viscosity. However, the additive boosted sample compactability, and reduced air voids. As the additive foamed the asphalt binder, it facilitated the coating of aggregates and binder. In addition, greater resistance under monotonic loading (S/F) was observed when HUSIL/AC = 1% (Figure 4). The increase in the Marshall S/F ratio was the work of the stiffer modified asphalt binder due to the additive's application (see Figures 1 and 2, tables 4 and 5). Not only did the additive increase binder stiffness, but it also enhanced mixture workability compactability and led to less air voids. When HUSIL/AC = 1% was used and the mix temperature reduced by 30°C (from 150°C to 120°C), WMA-25 developed resistance under monotonic loading (S/F) similar to that of the control HMA-25, with the latter group relying on a mixing temperature of 150°C, air voids between 4% and 6% and the HUSIL/AC ratio at 0%.



**Figure 3.** Evolution of Air Voids for Modified (HUSIL/AC = 1%, 2%, 3%) and Unmodified (HUSIL/AC = 0%) Mixtures

**Source:** Own work.

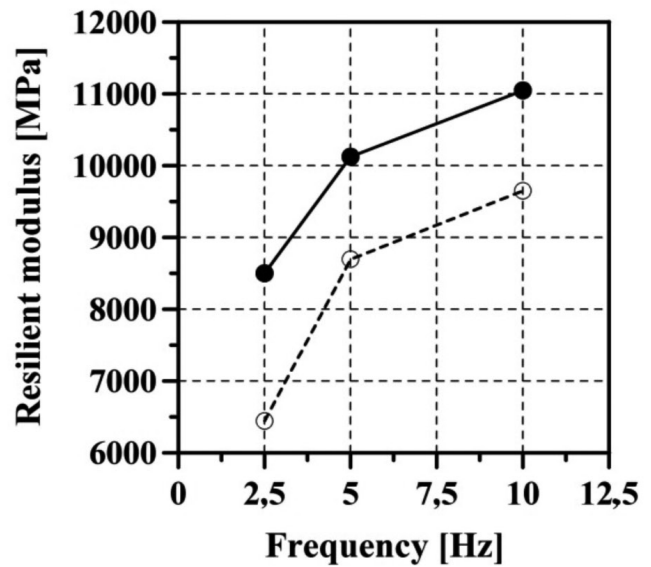




**Figure 4.** Evolution of Stability and Flow Ratio for Modified (HUSIL/AC = 1%, 2%, 3%) and Unmodified (HUSIL/AC = 0%) Mixtures

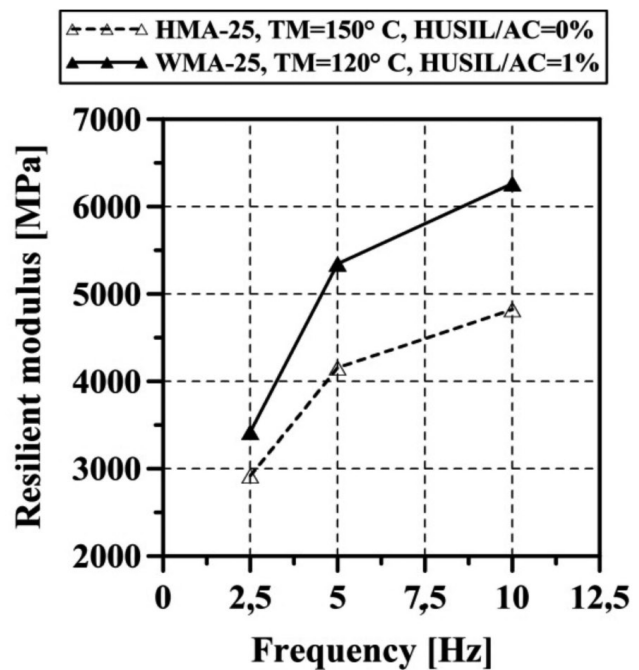
Source: Own work.

Figures 5, 6 and 7 furnish readers with information regarding the evolution of the resilient modulus. WMA mixtures (HUSIL/AC = 1%, mix temperature  $T = 120^{\circ}\text{C}$ ) saw resilient modulus increases compared to the control HMA mixture (HUSIL/AC = 0%, mixing temperature  $T = 150^{\circ}\text{C}$ ) for temperatures of  $5^{\circ}\text{C}$ ,  $15^{\circ}\text{C}$  and  $40^{\circ}\text{C}$ . This demonstrates that the WMAs are better suited to resist permanent deformation. Figure 8 encompasses rutting performance results. Based on all rutting data measured, WMA mixture proved to be a better choice than the control HMA mixture. On account of the simultaneous interaction between stiffer modified binders and better aggregate interlock (less air voids) in WMAs, it should come as no surprise that WMA-25 mixture lasted until 120 minutes for the rutting test, with 3 mm less rut depth than the control HMA-25 mixture.



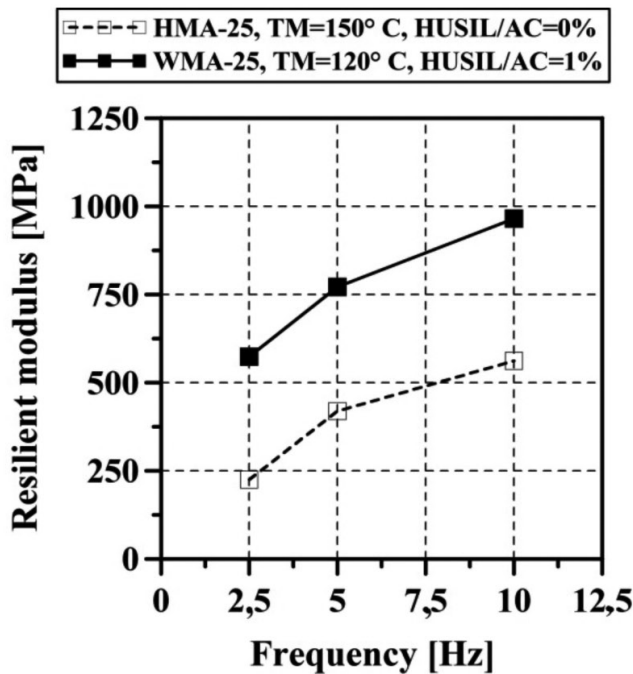
**Figure 5.** Evolution of the Resilient Modulus at  $5^{\circ}\text{C}$  (HMA-25 and WMA-25)

Source: Own work.



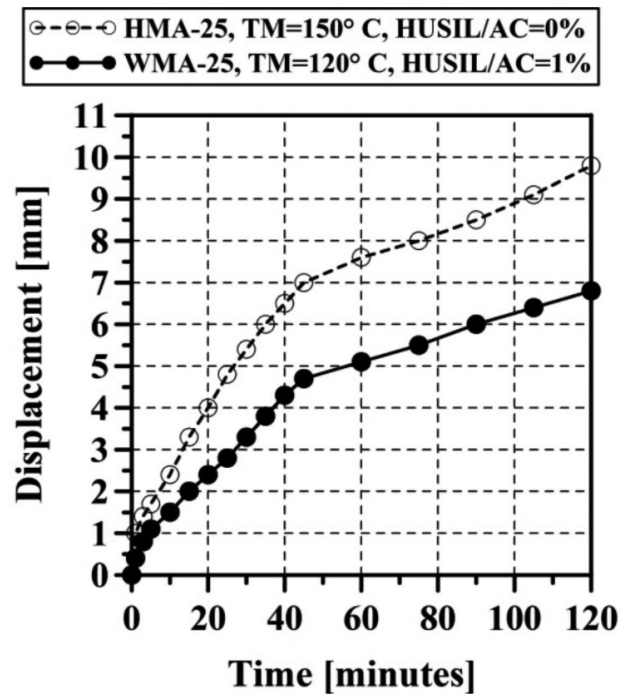
**Figure 6.** Evolution of the Resilient Modulus at  $15^{\circ}\text{C}$  (HMA-25 and WMA-25)

Source: Own work.



**Figure 7.** Evolution of the Resilient Modulus at 40° C (HMA-25 and WMA-25)

Source: Prepared by authors.



**Figure 8.** Results for Permanent Deformation Test (HMA-25 and WMA-25)

Source: Own work.

**Table 6.** Resistance to Moisture-Induced Damage

Mixture	Air Voids [%]	Standard	Sample Condition		TSR (S2/S1) [%]
			Dry S1 [kPa]	Moist S2 [kPa]	
HMA-25 (HUSIL/AC = 0%, T = 150° C)	6,8	AASHTO T	2785	2109	75,7%
WMA-25 (HUSIL/AC = 1%, T = 120° C)	6,6	283-03	2811	2276	81%

Source: Own work.

Table 6 contains information on resistance to moisture-induced damage. The ITS test results showed no significant difference between the HMA and WMA mixtures. In the unconditioned state (dry), the control WMA developed slightly greater ITS under monotonic loading. Additionally, the WMA had higher TSR and improved moisture damage resistance, i.e. neither additive had any detrimental effect on susceptibility to water even though the mixtures were produced at lower

temperatures. Moreover, the WMA mixture had the highest ITS in a conditioned state (wet). Therefore, the higher tensile strength values of WMA mixtures can be attributed to the tensile modified binder's performance.

## CONCLUSIONS

The present study evaluates a WMA mixture by looking at its mechanical strength under monotonic

and dynamic loading and resistance to moisture damage. The WMA was prepared with a liquid chemical additive used to foam the asphalt binder. In order to assess experimental WMA performance, Marshall, resilient modulus, rutting and indirect tensile strength tests were carried out, and a comparative analysis between traditional HMA and the WMA was performed. Armed with laboratory results, the following conclusions can be drawn:

Even when additive content is low (HUSIL/AC = 1%), significant changes are generated in the binder's properties: stiffness and PG increase at high service temperatures. Additionally, PG at intermediate service temperatures exhibits improvement when HUSIL is used.

HUSIL significantly reduces mixture temperatures (by 30°C). It is worth noting that additive not only lowers temperatures and improves workability in the compaction process, but it also stiffens the asphalt binder.

Based on results from Marshall, resilient modulus, rutting and ITS tests, it can be said that the WMA mixture (mixed at 120°C) displays greater resilient modulus numbers, as well as strength under monotonic loading, versus the control HMA mixture (T = 150°C) at high service temperatures. Furthermore, WMA mixtures exhibit slight improvements in terms of resistance to moisture damage and rutting (when compared to control HMA).

## REFERENCES

- Ameri, M., Hesami, S. & Goli, H. (2013). Laboratory evaluation of warm mix asphalt mixtures containing electric arc furnace (EAF) steel slag. *Construction Materials and Pavement Design*, (49), 611-617. [falta ciudad y editorial]
- Behl, A., Kumar, G., Sharma, G., & Jain, P. K. (2013). Evaluation of field performance of warm-mix asphalt pavements in India. *Procedia - Social and Behavioral Sciences*, (104), 158-167.
- Behnia, B. et al. (2011). Effects of recycled asphalt pavement amounts on low-temperature cracking performance of asphalt mixtures using acoustic emissions. *Transportation Research Record*, (2208), 64-71.
- Biro, S., Gandhi, T. & Amirkhanian, S. (2009). Midrange temperature rheological properties of warm asphalt binders. *Journal of Materials in Civil Engineering*, 21(7), 316-323.
- Blankendaal, T., Schuur, P. & Voordijk, H. (2014). Reducing the environmental impact of concrete and asphalt: a scenario approach. *Journal of Cleaner Production*, (66), 27-36.
- Bonaquist, R. (2011). *Mix design practices for warm mix asphalt*. National Cooperative Highway Research Program - NCHRP. Washington DC: TRB.
- Capitão, S., Picado-Santos, L. & Martinho, F. (2012). Pavement engineering materials: review on the use of warm-mix asphalt. *Construction and Building Materials*, (36), 1016-1024. [falta ciudad]
- Doyle, J. & Howard, I. (2013). Rutting and moisture damage resistance of high reclaimed asphalt pavement warm mixed asphalt: loaded wheel tracking vs. conventional methods. *Road Materials and Pavement Design*, 14(S2), 148-172.
- Estakhri, C. K., Cao, R., Álvarez, A. & Button, J. (2009). Production, placement and performance evaluation of warm mix asphalt in Texas. *GeoHunan International Conference 2009*, 1-8. Washington, DC: ASCE.
- Goh, S. W., Hasan, M. R. & You, Z. (2013). Performance evaluation of Cecabase® RT in warm mix asphalt technology. *Procedia - Social and Behavioral Sciences*, (96), 2782-2790.
- Hajj, E. Y., Souliman, M. I. & Cortez, E. M. (2014). Influence of warm mix additive on mechanistic, economical, and environmental attributes of a polymer-modified asphalt mixture. *Advances in Civil Engineering*, 3(1), 88-106.]
- Hassan, M. (2010). Evaluation of the environmental and economic impacts of warm-mix asphalt using life-cycle assessment. *International Journal of Construction Education and Research*, 6(3), 238-250.
- Hill, B., Behnia, B., Buttlar, W. & Reis, H. (2013). Evaluation of warm mix asphalt mixtures containing reclaimed asphalt pavement through mechanical

- performance tests and an acoustic emission approach. *Journal of Materials in Civil Engineering*, 25(12), 1887-1897.
- Hossain, Z. & Zaman, M. (2013). Behavior of selected warm mix asphalt additive modified binders and prediction of dynamic modulus of the mixes. *Journal of Testing and Evaluation*, 41(1), 1-12.
- Howard, I., Doyle, J., & Cox, B. (2013). Merits of reclaimed asphalt pavement-dominated warm mixed flexible pavement base layers. *Road Materials and Pavement Design*, 14(S2), 106-128. [falta ciudad]
- Howard, I. et al. (2014). Emergency paving using hot-mixed asphalt incorporating warm mix technology. *International Journal of Pavement Engineering*, 15(3), 202-214.
- INVIAS, I. N. (2013). *Especificaciones generales de construcción de carreteras*. Bogotá D.C.: INVIAS.
- Kim, Y., Zhang, J. & Ban, H. (2012). Moisture damage characterization of warm-mix asphalt mixtures based on laboratory-field evaluation. *Construction and Building Materials*, (31), 204-211.
- Kristjansdottir, O., Muench, S., Michael, L. & Burke, G. (2007). Assessing potential for warm-mix asphalt technology adoption. *Transportation Research Record*, (2040), 91-99.
- McDaniel, R., Shah, A., Huber, G. & Gallivan, V. (2007). Investigation of properties of plant-produced RAP mixtures. *Transportation Research Record*, (1998), 103-111.
- Mogawer, W., Austerman, A. & Bahia, H. (2011). Evaluating the effect of warm-mix asphalt technologies on moisture characteristics of asphalt binders and mixtures. *Transportation Research Record*, (2209), 52-60.
- Mogawer, W., Austerman, A. Mohammad, L. & Kutay, M. (2013). Evaluation of high RAP-WMA asphalt rubber mixtures. *Road Material and Pavement Design*, 14(S2), 129-147.
- Mokhtari, A. & Nejad, F. M. (2013). Comparative study on performance of wax-modified and typical SMA mixtures. *Journal of Materials in Civil Engineering*, 25(3), 419-427.
- Morea, F., Marcozzi, R. & Castaño, G. (2012). Rheological properties of asphalt binders with chemical tensoactive additives used in warm mix asphalts (WMAs). *Construction and Building Materials*, (29), 135-141.
- Nejad, F., Azarhoosh, A., Hamedi, G. & Roshani, H. (2014). Rutting performance prediction of warm mix asphalt containing reclaimed asphalt pavements. *Road Materials and Pavement Design*, 15(1), 207-219.
- Prowell, B., Frank, B., Osborne, L., Kriech, T. & West, R. (2014). *Effects of WMA on plant energy and emissions and worker exposures to respirable fumes*. National Cooperative Highway Research Program - NCHRP. Washington, DC: TRB.
- Robjert, L. & Dosh, W. (2009). Warm-mix asphalt for rural county roads. *Cold Regions Engineering 2009*, 438-454. Washington, DC: ASCE.
- Romier, A., Audeon, M., David, J. & Martineau, Y. (2006). Low-energy asphalt with performance of hot-mix asphalt. *Transportation Research Record*, (1962), 101-112.
- Rondón, H., & Reyes, F. (2015). *Pavimentos - Materiales, Construcción y Diseño*. Bogotá: ECOE Ediciones.
- Rossi, D., Filippi, S., Merusi, F., Giuliani, F., & Polacco, G. (2013). Internal structure of bitumen/polymer/wax ternary mixtures for warm mix asphalts. *Journal of Applied Polymer Science*, (129), 341-354.
- Rubio, M. C., Martínez, G., Baena, L. & Moreno, F. (2012). Warm mix asphalt: an overview. *Journal of Cleaner Production*, (24), 76-84.
- Sterling, V. (2012). *Special mixture design considerations and methods for warm mix asphalt: a supplement to NCHRP Report 673: a manual for design of hot mix asphalt with commentary*. National Cooperative Highway Research Program - NCHRP. Washington, DC: TRB.
- Tan, Y., Guo, M., Xu, H. & Zhang, R. (2012). Comparative study on laboratory performance of hot- and warm-mix asphalt mixtures. *Journal of Testing and Evaluation*, 40(5), 1-9.
- Tao, M. & Mallick, R. (2009a). Effects of warm-mix asphalt additives on workability and mechanical properties of reclaimed asphalt pavement material. *Transportation Research Record*, (2126), 151-160.
- Tao, Z., Huang, W., Du, Q. & Yan, J. (2009). Warm mix asphalt technology applied at low air temperature



- in China. *Road Materials and Pavement Design*, 10(S1), 337-347.
- Topal, A., Sengoz, B., Kok, B., Yilmaz, M., Dokandari, P. A., Oner, J. et al. (2014). Evaluation of mixture characteristics of warm mix asphalt involving natural and synthetic zeolite additives. *Construction and Building Materials*, (57), 38-44.
- United Nations Economic Commissions for Europe - UNECE. (2013). *Globally Harmonized System of Classification and Labelling of Chemicals – GHS* (Fifth ed.). Europe: ONU.
- Vasconcelos, K., Bhasin, A. & Little, D. (2010). Influence of reduced production temperatures on the adhesive properties of aggregates and laboratory performance of fine aggregate-asphalt mixtures. *Road Materials and Pavement Design*, 11(1), 47-64.
- Vidal, R., Moliner, E., Martínez, G. & Rubio, M. (2013). Life cycle assessment of hot mix asphalt and zeolite-based warm mix asphalt with reclaimed asphalt pavement. *Resources, Conservation and Recycling*, (74), 101-114.
- Wang, C., Hao, P., Ruan, F., Zhang, X. & Adhikari, S. (2013). Determination of the production temperature of warm mix asphalt by workability test. *Construction and Building Materials*, (48), 1165-1170.
- Wasiuddin, N., Selvamohan, S., Zaman, M. & Guegan, M. (2007). Comparative laboratory study of Sasobit and Aspha-Min additives in warm-mix asphalt. *Transportation Research Record*, (1998), 82-88.
- West, R., Rodezno, C., Julian, G. & Prowell, D. (2014). *Engineering properties and field performance of warm mix asphalt technologies*. National Cooperative Highway Research Program - NCHRP. Washington, DC: TRB.
- Wu, C. & Zeng, M. (2012). Effects of additives for warm mix asphalt on performance grades of asphalt binders. *Journal of Testing and Evaluation*, (40), 265-272.
- You, Z., & Goh, S. (2008). Laboratory evaluation of warm mix asphalt: a preliminary study. *International Journal Pavement Research and Technology*, 1(1), 34-40.
- Yu, X., Leng, Z. & Wei, T. (2014). Investigation of the rheological modification mechanism of warm-mix additives on crumb-rubber-modified asphalt. *Journal of Materials in Civil Engineering*, 26(2), 312-319.
- Zhao, W., Xiao, F., Amirhanian, S. N., & Putman, B. J. (2012). Characterization of rutting performance of warm additive modified asphalt mixtures. *Construction and Building Materials*, (31), 265-272.





## Development of a uml framework for smart cities with forecasting electrical consumption in Colombia

### Desarrollo de un marco de referencia uml para ciudades inteligentes con predicción de consumo eléctrico en Colombia

Ricardo Alirio González Bustamante\*, Roberto Ferro Escobar\*\*,  
Giovanni Tarazona Bermúdez\*\*\*

**Fecha de recepción:** June 10th, 2014

**Fecha de aceptación:** November 4th, 2014

**Citation / Para citar este artículo:** González Bustamante, R. A., Ferro Escobar, R., & Tarazona Bermúdez, G. (2014). Development of a UML framework for smart cities with forecasting electrical consumption in Colombia. *Revista Tecnura*, 18 (Edición especial doctorado), 109–123. doi: 10.14483/udistrital.jour.tecnura.2014.DSE1.a10

#### ABSTRACT

The following article describes a proposal that aims to plan and develop a framework for Smart cities using modeling by UML through the Colossus software tool. Further design analysis applied to Smart cities based on wireless sensor networks is developed.

The analysis is proposed using ARIMA time series for finding a correlation of consumption of electricity in 50 Colombian homes and a possible forecast if it were used Internet of things (IoT) as a possible method to save on electrical energy consumption.

**Keywords:** ARIMA, Framework, Gretl, Smart cities, UML, WSN.

**Palabras clave:** ARIMA, Ciudades inteligentes, Framework, Gretl, UML, WSN.

\* Electronic Engineer, Master in Teleinformática. PhD Student, Teacher-researcher at the Autonomous University of Colombia. Faculty of Engineering, Bogotá, Colombia. [gonzalez.ricardo@fuac.edu.co](mailto:gonzalez.ricardo@fuac.edu.co)

\*\* Electronic Engineer, PhD in Computer Engineering. PhD Coordinator, District University Francisco José de Caldas. Faculty of Engineering, Bogotá, Colombia. [rferro@udistrital.edu.co](mailto:rferro@udistrital.edu.co)

\*\*\* Systems Engineer, PhD in Software Engineering, District University Francisco José de Caldas. Faculty of Engineering, Bogotá, Colombia. [gtarazona@udistrital.edu.co](mailto:gtarazona@udistrital.edu.co)

## INTRODUCTION

The scientific investigation has a method, and this one has, your approaches and exceptions as well as your dimensions, with the possibility of using one or another way of the method. When an investigation is done in the technological field, it is necessary to use technological strategies, which validate the results obtained across a software development of software;. This article they presents the results of the utilization of the Unified Language Unified of Shaped UML (Bolaños, González, Sanjuan & Easter, s. f.) to shape the graphs of case of use, sequence, of class and activities with support in the tool named Coloso (Bolaños, González, Sanjuan, & Pascual ) (Bolaños, Medina, & Carrión, LACCEI, 2011).; This paper presents an analysis relationing the Engineering software (IS) using the Language of Shaped of Processes and Methodologies of Software [LMMPS] (Bolaños, Medina & Carrión, LACCEI, 2011). The approach to realizing carry out will combine the investigation and technology, with IS technics of the (IS).

## LANGUAGE MODEL AND METODOLOGIC PROCESS OF SOFTWARE (LMMPS)

The concepts of grammar are described to construct words of a certain language. The intention aim is generating a vocabulary of expression for the frame of a (SC).

1) The gGrammar with phrases structure consists of a vocabulary  $V$ , a subset  $T$  of  $V$  formed by the end effectors and initial symbol  $S$  of  $V - T$  and a set  $P$  of productions (Bolaños S., 2014; Rosen, 2004).

2) The vVocabulary ( $V$ ) is a finite set and non-empty, the elements are called symbols, where a word on  $V$  is a finite chain of elements of  $V$  (Bolaños S., 2014; Rosen, 2004).

It is necessary to define the language generated for  $G, L (G)$

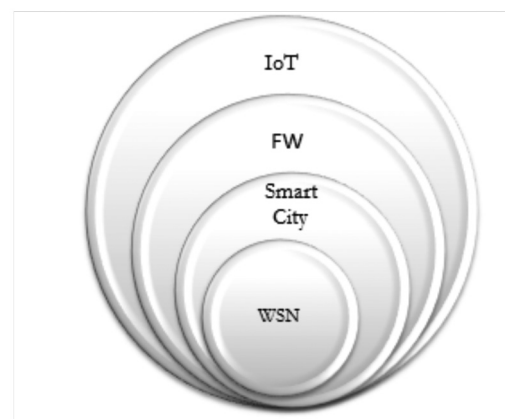
For a consistent set of aspects where IoT (Internet of Things) is, the Internet of the things and FW

(Framework) is the working space or referential frame.

Therefore, if WSN SC are elements of the set FW;, then, because each element of C sublies is contained in IoT.

IoT is a function of FW, (Framework) SC , (Smart Cities),and WSN (Wireless Sensor Networks), where it is possible to verify and validate. Wifhere IM is defined as Internet in Movement.

Next, it presents a general graph of the services classification, in the top part appears (IoT), which wraps the (FW), the (SC) and (WSN). The structures WSN sublies before the (SC) and this one sublies before the (FM), which forms a part integral of (IoT).



**Figure 1.** Integration and perspective of Smart Cities (SC) and IoT

**Source:** Author.

## PRECEDENTS AND CURRENT STATE OF THE ART

The conceptual development of this project is necessary to understand four big components: (IoT), ( FW), (WSN), (SC); the comprehension and deepening of these subject matters, the props of this offer, will depend ofn the design that is achieved in a great extent with the success of the same one.

## Internet of the (IoT)

Defined as a global infrastructure based on standards and communication protocols where the physical and virtual "things" are equally integrated with the network information. Important and essential part of IoT are the sensors (Vergara Carabehnó & June, 2013).

## Framework (FW)

A frame of reference is used as a development pattern of an application, though it is a wide definition, this designation because it can remove the different levels of software development (Ffor a complete application defined, application web, until focusing in an unique aspect, user interface) (Cavaness, 2003), being versatile without requiring a language of programming. [FW] is defined also as a set of bookshops, designed to give support in the development of sites generating the construction of any web application (Lyman, 2009). A [FW] facilitates with common activities realized carried out during the development of the application (Brandon & Brandon, 2008).

Some characteristics are evaluated in the table 1:

**Table 1.** Characteristics are evaluated in the selection of Framework (FW)

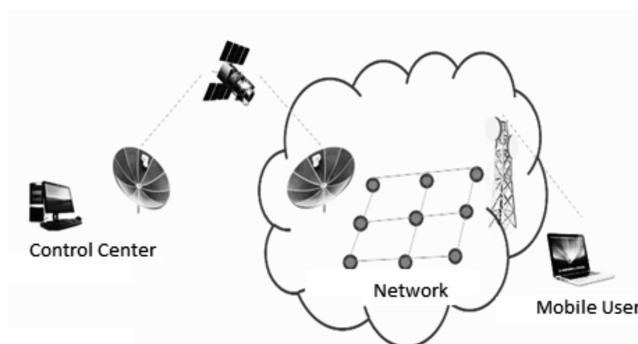
FEATURES	DESCRIPTION	AUTHORS
Domain (FW):	has as purpose recognize the requirements and concepts that the (FW) needs (Shafer, Prieto, & Matsumoto)	
Security FW	FW Support and security in the infrastructure	(Bae, 2014) (Rasmussen & Dara, 2014).
Interoperability	Interact with other platforms	(Ahamed, Milwaukee, & Pezewski, 2004) (Jin Oh & Youl Park, 2014)

**Source:** Own work.

The Framework (FW) design is necessary to take in mind allowing total access and control at sensors network, for any device with connectivity.

## Wireless Sensor Network (WSN)

WSN are networks for small nodes that working to obtain a common objective with resources of accused and computation limited. In the beginning of this evolution, the nodes were big distant stations, spatially and the communication would take place across an infrastructure wired up (Akyildiz, Weilian, Sankarasubramaniam, and & Cayirci, 2002). Since then different investigations have been developed in order to improve of the sensors in caps: physic, link and network optimizing for the processes of transmission with the objective, diminishing the energy consumption (AUTELSI (Association), 2006). Nowadays, the communication is wireless and when exists an exchanges of information between nodes conforms a networks (Hao, Xue, Yan, and & ChunLi, 2012). It is necessary to take control that supervises the connections between the net, as the information is caught by the sensors networks; in general, the information is bidirectional for user to the net and vice versevica versa. This scheme is shown in Figure 2.



**Figure 2.** Basic scheme for a WSN

**Source:** Own work.

Some considerations to bearing in mind for designing a WSN are described in table 2.

**Table 2.** Considerations to bearing in mind for designing a WSN

Characteristics:	Definition:
Tolerance for failures	Some nodes sensors can fail or be blocked due to the lack of energy, or to receive physical damages or environmental interferences. The failure of nodes sensors must not compromise the global function global in the net of sensors.
Scalability.	The designs must be capable of working with a number of nodes in order of hundreds, thousands, and depending on applications, millions. Also take in mind the high density, which can take have relation to some hundreds of nodes sensors in a region that can be minor than 10 meters by diameter.
Costs of production	Provided that the sensors networks consist of a great number of sensors nodes, the cost of an individual node is very important to justify the complete cost of the network.
Topology	The topology can suffer changes due to function mistakes, involuntary changes in position of nodes sensors, interferences with objects for the environment. Later, it is possible to precede methods like repair, substitution or amplification at network.
Environment	The sensors networks meet are affected for the environment. Normally they are opened in remote areas, the difficult or impossible access being nearby or inside with phenomenon where wants to be measure.
Hardware limitation	A sensor network is constituted for four basic components: sensor unit, a processor, transmitter, and energy unit.

**Source:** Own work.

Authors whom works in this topics are: (Liyanage & Marasinghe, (2013), (Kehua, Jie, & Hongbo, (2011), (Elmangoush, Coskun, Wahle, & Magedanz, (2013), (Karnouskos & de Holanda,

(2009) (Chourabi, y otroset al., (2012), (Chaonan, Liudong, Vinod, & Yan Lindsay, (2014).

## Smart City (SC) and Digital City

Knowing as Digital or Intelligent City, is considered as an city "intelligent" city when the investments in the human and social capital, and a traditional infrastructures in a traditional communication (transport) and modern (ITC), they foment an economic development and a high quality of life, knowing the management of natural resources, across a participative government (AUTELSI (Association), 2006) (Hao, Xue, Yan & ChunLi, 2012) (Liyanageand Marasinghe, 2013).

Digital city: is a virtual space of interaction between all the actors whom take part in the life of a city, citizens, companies, administrative, visitors, - using the support of the electronic and the information, and communication technologies and communication (TicsICTs), offering the above mentioned actors, the access like an innovative way of relation and communication, across the channel that they choose, in any moment and place (Kehua, Jie & Hongbo, 2011; Elmangoush, Coskun, Wahle & Magedanz, 2013; Kamoouskos & Holands, 2009; Chourabi et al., 2012).

## PROBLEM DEFINITION

The high consumption of electrical energy with in the big cities and every time scanty generation of the same one, generating a crisis in the energetic sector; it is not enough to create saving policies, saving but also it is necessary the implementation of intelligent networks that allow manage the energetic saving (Krishnamachari & Ordóñez, 2003). Some disadvantages could be nowadays exists and is related to the energy consumption.

## METODOLOGY:

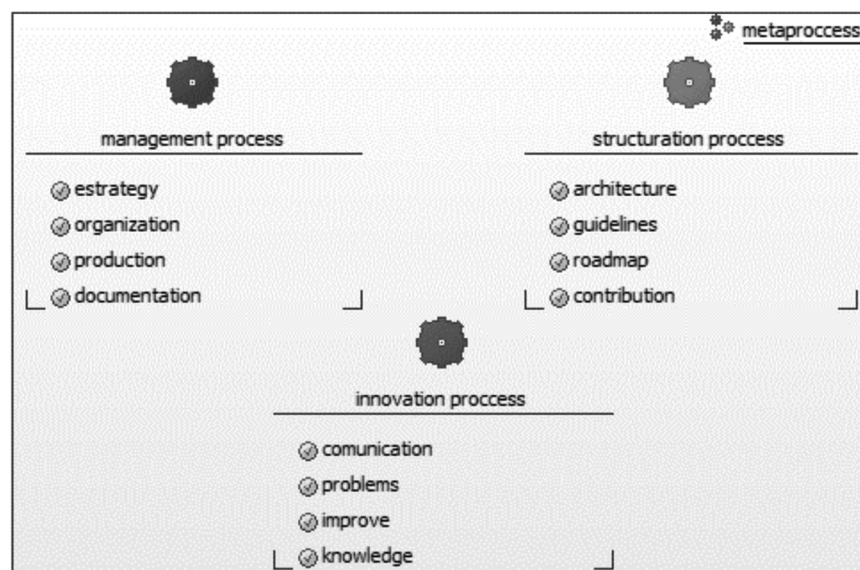
### *Metaprocess definition:*

"The significant problems we have cannot be solved at the same level of thinking with which we created them". Albert Einstein.

For the development of reference frame was used UML that is a language that allows shape, construct and document the elements that form a system in object orientated software.; in the present article - there will develop the model of software Metaprocess (Bolaños, González & Easter,

s. d.; Bolaños, Medina & Carrión, LACCEI, 2011). The Metaprocesses (Gracanin, Eltoweissy, Olariu & Wadaa, 2004), is defined as process models who which are going to serve as referential frame, and they help with a graphical scheme of representation. Three big processes are distinguished: management, structure and innovation.

The process management, is shaped by the strategy, organization, production and documentation. In Coloso is possible to estimate in a graphical and pedagogic way 3 processes that shape a Metaprocess. (figure 3).



**Figure 3.** Metaprocess from Coloso software

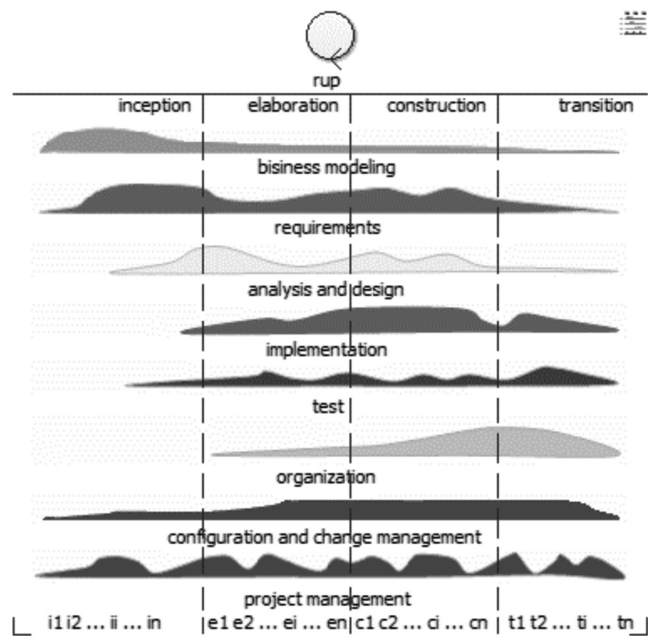
**Source:** Bolaños, González, Sanjuan, & Pascual.

As a strategy, the holistic looks about problem and the hypothesis; the strategy or process selected RUP (Rational Unified Rational Process) (Peng, Wang, Have & Zhao, 2012), the life cycle is used in cascade (Royce, 1970), allowing the generation of a software in an UML environment UML, design, develop and visualize processes; simplifying the complexity of the designs, processes and creating a development without equally. The process RUP assigns tasks and responsibilities; shaped by the strategies: business models, requirements,

analysis and design, implementation, checking, between among others.

Additionally, the RUP administrates the requirements, which are dynamic during the project, develops the iterative software, develop sand the software visually, evaluates the system quality with regards to the functionality, uses an architecture based on components and establishes repetitive processes to manage the changes of software (Flórez, 2009; Abranson, 2002; Kasaju, 2013) This process is shown in the Figure 4 shows this process.

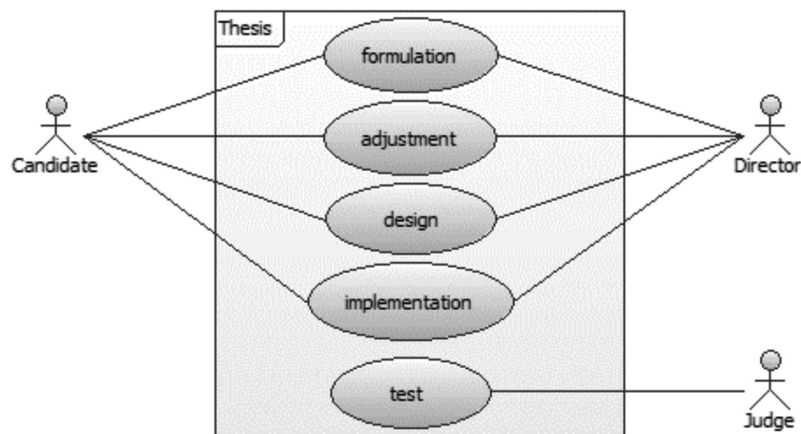




**Figure 4.** Methodology RUP

**Source:** Bolaños, González, Sanjuan, & Pascual.

For the particular case that occupies us, the model of business is represented in Figure. 4.



**Figure 5.** Use case activities

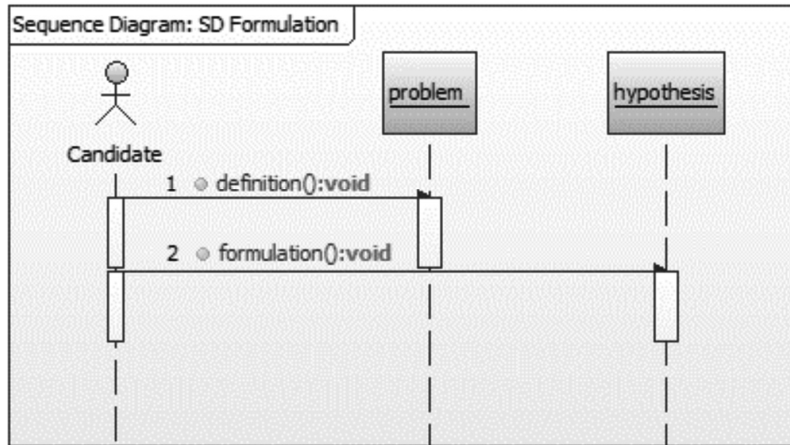
**Source:** Bolaños, González, Sanjuan, & Pascual.

The use case, describes the general activities in the development of the (FW)] for - SC - (Elman-goush, Coskun, Wahle & Magedanz, 2013). Three actors decided the Ph.dD candidate, the direc-tor and judge, where are represented the general

activities that will allow to develop and give solu-tion to the project; this one is composed for five activities:; formulation, adjustments, design, im-plementation, tests and socialization for the results in the academic community.

The following provides developments of the formulation activity, in which the thesis taking part in problem approach and investigation hypothesis

who will find be resisted. These processes are shown in the Figure 6 shows these processes.

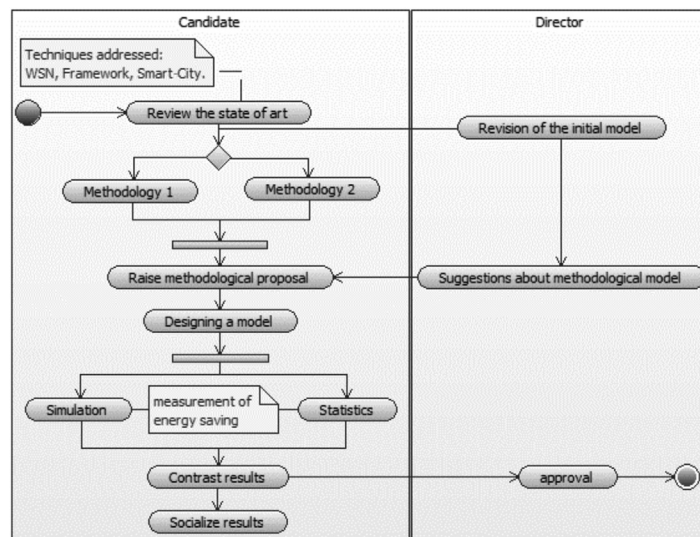


**Figure 6.** Problem and hypothesis formulation

**Source:** Bolaños, González, Sanjuan, & Pascual.

Taking again the Sstrategy about Metaprocess, begins the specification of the activities, which will be orientated to project objective, which is

developed in a Frame of Reference for Intelligent Cities controlling a sensor wireless network in Smart City applications,. tThis allows the energetic saving, ias shown in figure 7.



**Figure 7.** Developing activities about methodology

**Source:** Bolaños, González, Sanjuan, & Pascual.

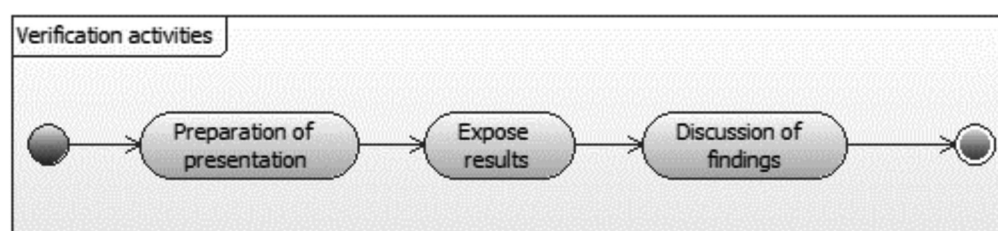
In the project developing of project are definite two actors:, the director and the candidate Ph.D; with the following function review the state of

the art state condition, including the approached subject matters (WSN), (FW) and (SC). Once the previous task has been realized carried out and

agreement with results obtained, it will be decided, by mutual agreement, a specific methodology to identify the methodological offer that will include the suggestions realized given by the director, the bidder will realize carry out part of design in a model (FW) who will be used in the simulations accomplishment and statistics which have information about energy consumption in homes respect to the level; the contrasting results will be

realizedmade. This point is important because here culminatingends the traceability reached by the director; later, results obtained will socialize previous approval by the director.

The activity appears the contrasts Figure 8 in which present the results, conclusions and confronts with the judge for your checking. This activity is conducted through checking the hypothesis of investigation.



**Figure 8.** Verification activities and conclusion

**Source:** Bolaños, González, Sanjuan, & Pascual.

## STUDY OF AN APPLICATION OF ENERGY SAVING AT HOME AND FORECAST

The first forecast, the home energy consumption performed measurements of 50 home conformed by 4 persons who consumed around 4-6 kWh per day, there were extracted from the samples to be included in the Autoregressive Integrated Moving Average (ARIMA) model (Pulido, 2001). Mathematical models are a class of stochastic processes used to analyze time series is due according to Box and Jenkins model., wWe used a GRETL free software, which to analyzed the statistical behavior and represented through a graphical interface will be used.

**Table 3.** Sample for 50 real home user's from Codensa

Day	kWh-Mount	kWh-day	Variation
0	157	5,2	
1	190	6,3	33
2	165	5,5	-25

3	171	5,7	6
4	180	6,0	9
5	175	5,8	-5
6	169	5,6	-6
7	173	5,8	4
8	161	5,4	-12
9	152	5,1	-9
10	188	6,3	36
11	165	5,5	-23
12	194	6,5	29
13	199	6,6	5
14	174	5,8	-25
15	160	5,3	-14
16	159	5,3	-1
17	152	5,1	-7
18	164	5,5	12
19	167	5,6	3
20	186	6,2	19
21	147	4,9	-39
22	180	6,0	33
23	158	5,3	-22
24	169	5,6	11
25	175	5,8	6

26	149	5,0	-26	38	181	6,0	-52
27	172	5,7	23	39	141	4,7	-40
28	189	6,3	17	40	112	3,7	-29
29	171	5,7	-18	41	145	4,8	33
30	166	5,5	-5	42	193	6,4	48
31	190	6,3	24	43	103	3,4	-90
32	174	5,8	-16	44	111	3,7	8
33	197	6,6	23	45	207	6,9	96
34	149	5,0	-48	46	195	6,5	-12
35	182	6,1	33	47	161	5,4	-34
36	204	6,8	22	48	217	7,2	56
37	233	7,8	29	49	193	6,4	-24
				<b>50</b>	<b>133</b>	<b>4,4</b>	<b>-60</b>

Source: Own work.

The Table 3 data kWh-day for 50 home user's, are represented in the following GRETL graphic:

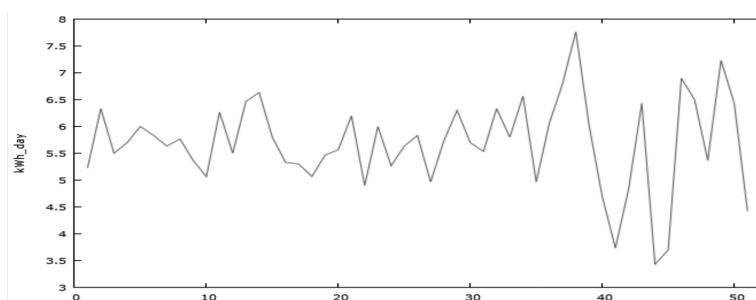


Figure 9. Time series original function in GRETL

Source: Own work.

After analyzing the statistical behavior, it is necessary to take the first difference occurs as shown in the Figure 10:

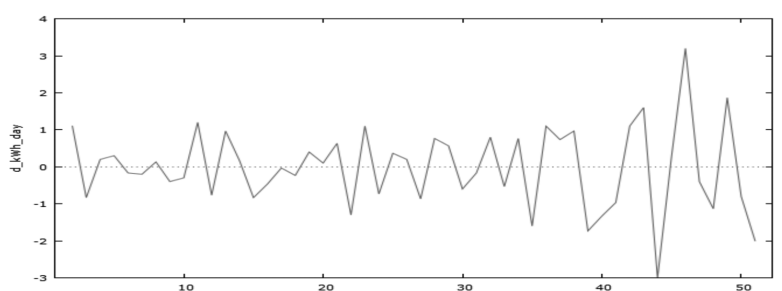


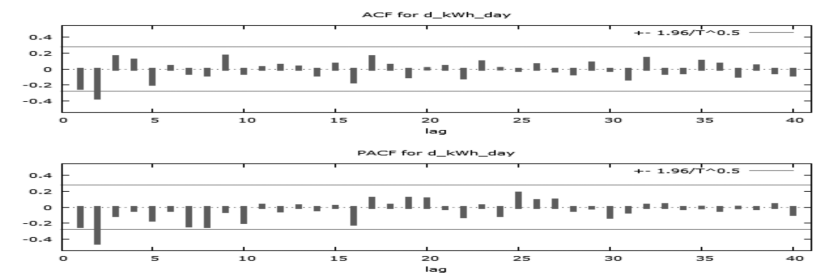
Figure 10. Plot time series function and his first derivate

Source: Own work.

Autocorrelation function for d_kWh_day				
LAG	ACF	PACF	Q-stat.	[p-value]
1	-0.2406 *	-0.2406 *	3.0719	[0.080]
2	-0.3664 ***	-0.4503 ***	10.3431	[0.006]
3	0.1561	-0.1067	11.6913	[0.009]
4	0.1111	-0.0420	12.3893	[0.015]
5	-0.1869	-0.1595	14.4065	[0.013]
6	0.0355	-0.0380	14.4810	[0.025]
7	-0.0552	-0.2355 *	14.6654	[0.041]
8	-0.0763	-0.2414 *	15.0259	[0.059]
9	0.1632	-0.0556	16.7159	[0.053]
10	-0.0539	-0.1897	16.9050	[0.076]
11	0.0181	0.0250	16.9268	[0.110]
12	0.0447	-0.0468	17.0633	[0.147]

**Figure 11.** Correlogram values, about ACF (Auto Correlation Function) point and PACF (Partial Auto Correlation Function)

Source: Own work.



**Figure 12.** Correlogram time series function ACP and PACF

Source: Own work.

This difference gives the graph of its Correlogram, which has ACF (Auto Correlation Function) point and PACF (Partial Auto Correlation Function) points.

To perform observation users are taken as samples 40 crews is 80% and 20% is left to perform the prediction is shown in figure 12 Correlogram.

According to the coefficients obtained from the autocorrelation functions and partial autocorrelation prediction models based on the coefficients  $\rho$  AR(2) = -0,3664 ,  $q_1$   $q_2$  MA(2) = -0, 4503, and  $q_2$  MA(7) = -0, 2355, with and their ARIMA model combination ARIMA (2,1,2) from the equation 1:

$$(1-0.3664L)(1-L)Y_t = (1-0,4503L-0,2355)u_t \quad (1)$$

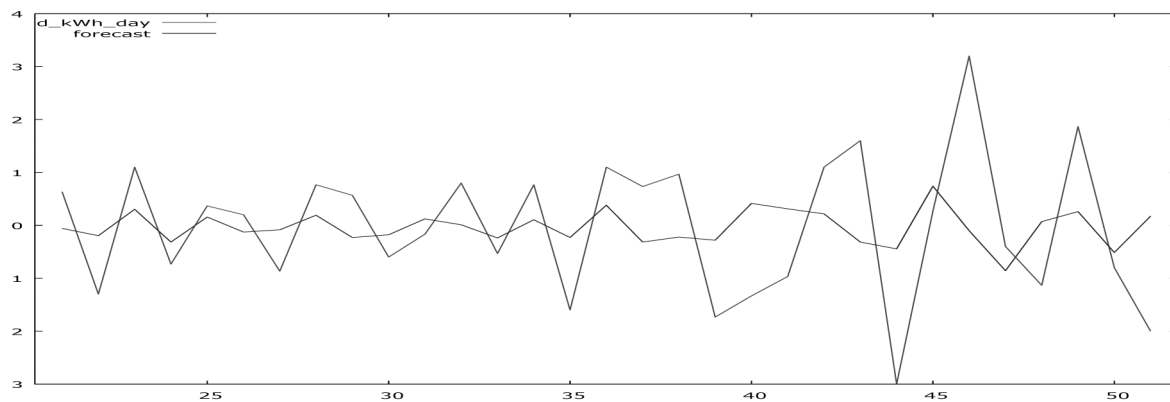
```

Function evaluations: 239
Evaluations of gradient: 59
Model 2: ARIMA, using observations 3-51 (T = 49)
Estimated using Kalman filter (exact ML)
Dependent variable: (1-L) d_kWh_day
Standard errors based on Hessian
-----
      coefficient      std. error      z      p-value
-----
const      -0.000373701      0.00107873      -0.3464      0.7290
phi_1       0.270962      0.146853      1.845      0.0650 *
phi_2      -0.214507      0.144957      -1.480      0.3889
theta_1     -1.99486      0.0958515      -20.81      3.37e-096 ***
theta_2     -0.999999      0.0958415      -10.43      1.74e-025 ***
-----
Mean dependent var      -0.063265      S.D. dependent var      1.693783
Mean of innovations     -0.054715      S.D. of innovations     0.820609
Log-likelihood          -65.65294      Akaike criterion       143.3059
Schwarz criterion       154.6568      Hannan-Quinn          147.6124
-----
      Real      Imaginary      Modulus      Frequency
-----
AR
Root 1      0.6316      -2.0647      2.1591      -0.2028
Root 2      0.6316      2.0647      2.1591      0.2028
MA
Root 1      0.9574      -0.0717      1.0000      -0.0114
Root 2      0.9574      0.0717      1.0000      0.0114
-----
    
```

**Figure 13.** ARIMA Model I (2.1.2) function evaluation

Source: Own work.





**Figure 14.** Graph ARIMA model 1 Forecast prediction

Source: Own work.

From the data provided in Figure 14 may function prediction plot for 50 samples in red differentiated function is presented and the corresponding forecast.

The Figure 15 presents the exact data for the differentiated function and data for function prediction also calculated the RMSE (Root Mean Square Error):

	d_kWh_day	prediction
21	0.632323	-0.058241
22	-1.300000	-0.195725
23	1.100000	0.302655
24	-0.732323	-0.316023
25	0.366667	0.136578
26	0.200000	-0.126983
27	-0.866667	-0.084019
28	0.766667	0.190949
29	0.566667	-0.230096
30	-0.600000	-0.178539
31	-0.166667	0.122207
32	0.800000	0.010501
33	-0.532323	-0.235659
34	0.766667	0.105022
35	-1.600000	-0.230096
36	1.100000	0.375990
37	0.732323	-0.316023
38	0.966667	-0.221503
39	-1.732323	-0.281652
40	-1.332323	0.414361
41	-0.966667	0.311248
42	1.100000	0.216727
43	1.600000	-0.316023
44	-3.000000	-0.444915
45	0.266667	0.740855
46	3.200000	-0.101204
47	-0.400000	-0.857367
48	-1.132323	0.070651
49	1.866667	0.259691
50	-0.800000	-0.513657
51	-2.000000	0.173764

Forecast evaluation statistics

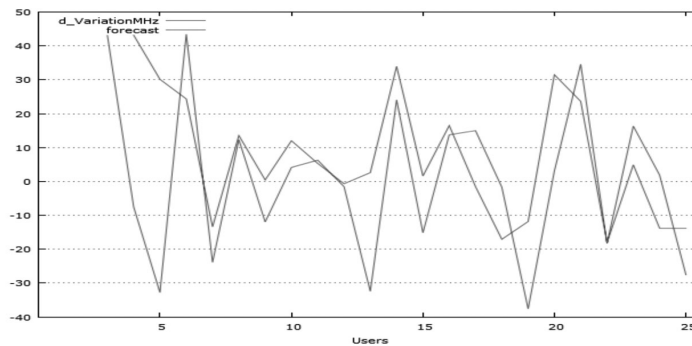
Mean Error	0.017594
Mean Squared Error	2.9804
Root Mean Squared Error	1.7264
Mean Absolute Error	1.4669
Mean Percentage Error	51.383
Mean Absolute Percentage Error	-1.3902
Theil's U	1.0858
Bias proportion, UM	0.00010386
Regression proportion, UR	0.0060519
Disturbance proportion, UD	0.99284

**Figure 15.** Model I ARIMA (2,1,2) function evaluation

Source: Own work.

From the data provided in the Figure 15 may function prediction plot for 50 samples in red differentiated function is presented in the Figure 16 red and the corresponding forecast.

differentiated function is presented in the Figure 16 red and the corresponding forecast.



**Figure 16.** ARIMA second model graph and forecast prediction

**Source:** Own work.

The Figure 17 presents shows the exact data for the differentiated function and data for function prediction also calculated the RMSE (Root Mean Square Error):

d_Variation	prediction	Forecast evaluation statistics	
2009-09-18	-55.00	Mean Error	-9.3269
2009-09-19	33.00	Mean Squared Error	1272.2
2009-09-20	-5.00	Root Mean Squared Error	35.668
2009-09-21	-32.00	Mean Absolute Error	34.434
2009-09-22	49.00	Mean Percentage Error	63.638
2009-09-23	-6.00	Mean Absolute Percentage Error	63.638
2009-09-24	-35.00	Theil's U	0.30464
2009-09-25	13.00	Bias proportion, UM	0.068376
2009-09-26	29.00	Regression proportion, UR	0.35904
2009-09-27	-40.00	Disturbance proportion, UD	0.57258
2009-09-28	39.00		
2009-09-29	-71.00		
2009-09-30	81.00		
2009-10-01	-11.00		
2009-10-02	7.00		
2009-10-03	-81.00		
2009-10-04	12.00		
2009-10-05	11.00		
2009-10-06	62.00		
2009-10-07	15.00		
2009-10-08	-138.00		
2009-10-09	98.00		
2009-10-10	88.00		
2009-10-11	-108.00		
2009-10-12	-22.00		
2009-10-13	90.00		
2009-10-14	-80.00		
2009-10-15	-36.00		
2009-10-16			

**Figure 17.** Model to data for function prediction I

**Source:** Own work.

**UML diagrams carried out**



**Figure 18.** UML diagrams results from Coloso

## RESULTS

In the graphs Figure 18 appears the percentage used from UML perspective; the approach was guided by percentage of utilization, which was 77 %, versus the total graphs of UML language, as well as the use diagram disaggregated that is 11 %.

The ARIMA models have been applied to predict the behavior energy consumption in home, from a growing number of peoples in a city, respectively. The Figures 12 and 13 corresponds to the Autocorrelation function for ACF, PACF. Behavior prediction is similar and is in agreement with the data included for the 50 samples submitted monthly consumption in households. Thus it is possible to make predictions much larger and that they are commensurate with the energy savings that can be estimated in the future near future.

## CONCLUSION

A formal investigation process, can be realized carried out using IS's methodology, with Coloso protocol A key search is utilization of approach based on independent components from technology, accompanied along with of a methodology that facilitates the model interpretation combines the (IS) with our offer. The mixed investigation methodologies and generating models software (IS) who which explain the problem.

The integration of software engineering UML diagrams and modeling engineering problems based on efficient as those used by software developers methodologies, can integrate these aspects with problems related to smart cities., in our case, to predict consumer behavior of electrical energy in homes and predicting them in and near future and thus achieving create predictive models of behavior.

## REFERENCES

Abranson, P. (2002). Agile Software Development Methods Review and Analysis . VTT.

- Ahamed, S., Milwaukee, W., & Pezewski, A. (2004). Towards framework selection criteria and suitability for an application framework. *Information Technology: Coding and Computing*, 2004. Proceedings. ITCC 2004. International Conference on (Volume:1 ), 1, 424-428.
- Akyildiz, I., Weilian, S., Sankarasubramaniam, Y., & Cayirci, E. (2002). A survey on sensor networks. *IEEE Communications Magazine*, 102-114.
- Androlaki, S. et al. (2014). Proposing a Smart City energy assessment framework. *IEEE Information, Intelligence, System and Applications IISA*.
- AUTELSI (Asociación). (2006). Elementos básicos para una ciudad digital . España: Documento elaborado por el grupo de trabajo de ciudades digitales .
- Bae, Y. (2014). A scalable user interface framework for multi-screening. *Consumer Electronics (ICCE)*, 2014 IEEE International Conference on (pp. 408 - 409). Las Vegas, NV.
- Bolaños, S. (2014). Software Processes and Methodologies Modeling, Language –SPMML– Holistic Solution for Software Engineering. *IEEE Latin America Transactions*, 818- 824.
- Bolaños, S., González, R., Sanjuan, O., & Pascual , J. (n.d.). Coloso-. A Development Environment Centered Process and Intent.
- Bolaños, S., Medina, V., & Carrión, J. (2011). *LACCEI. Marco conceptual para el metaproceto de desarrollo de software*. Medellín-Colombia.
- Bolaños, S., Medina, V., & González, R. (2014). Software Processes and Methodologies Modeling Language-SPMML- A Holistic Solution for Software Engineering. *Latin America transactions*. Vol. 4.
- Brandon, D., & Brandon, C. (2008). *Software Engineering for Modern Web Applications: Methodologies and Technologies*. Estados Unidos : Information Science Reference.
- Bulusu, N., Estrin, D., Girod, L., & Heidemann, J. (2001). Scalable coordination for wireless sensor network self-configuring localization systems. *Proc. 6th IEEE International Symposium on Communication Theory and Application*.
- Buratti, C., & Giorgetti, A. (2007). Cross-Layer Design of Energy Efficient Cluster Formation Algorithm

- with Carrier Sensing Multiple Access for Wireless Sensor Networks. *EURASIP Journal on Wireless Communications and Networking*.
- Cavaness, C. (2003). *Programming Jakarta Struts*. Sebastopol: O'Reilly & Associates, Inc.
- Chaonan, W., Liudong, X., Vinod, V., & Yan Lindsay, S. (2014). A phased-mission framework for communication reliability in WSN. *Reliability and Maintainability Symposium (RAMS), 2014 Annual, 1-7*.
- Chourabi, H. et al. (2012). Understanding Smart Cities: An Integrative Framework. *System Science (HICSS), 2012 45th Hawaii International Conference on*. Maui, HI.
- Elmangoush, A., Coskun, H., Wahle, S., & Magedanz, T. (2013). Design aspects for a reference M2M communication platform for Smart Cities. *Innovations in Information Technology (IIT), 2013 9th International Conference on*. Abu Dhabi.
- Emara, K., Abdeen, M., & Hashem, M. (2009). A gateway-based framework for transparent interconnection between WSN and IP network. *EUROCON 2009, EUROCON '09. IEEE, 1775-1780*.
- Ferro, R., González, R., & Velazco, S. (2013). Use of ARIMA mathematical analysis to model the implementation of expert system courses by means of free software OpenSim and Sloodle platforms in virtual university campuses. *Expert Systems Wwith Applications*. ISSN: 0957- 174. Ed: Elsevier. v. 40, 8381-7390.
- Flórez, H. (2009). *Procesos de Ingeniería de Software. Vínculos, 26-39*.
- Gracanin, D., Eltoweissy, M., Olariu, S., & Wadaa, A. (2004). On modeling wireless sensor networks. *Parallel and Distributed Processing Symposium, 2004. Proceedings. 18th International*.
- Hao, L., Xue, L., Yan, Z., & ChunLi, Y. (2012). The application and implementation research of smart city in China. *System Science and Engineering (ICSSE), 2012 International Conference on* (pp. 288 - 292). Dalian, Liaoning.
- Jin Oh , B., & Youl Park, J. (2014). A remote user interface framework for collaborative services using interconnected smart devices. *Advanced Communication Technology (ICACT), 2014 16th International Conference on*, 630 - 634.
- Karnouskos, S., & de Holanda, T. (2009). Simulation of a Smart Grid City with Software Agents. *Computer Modeling and Simulation, 2009. EMS '09. Third UKSim European Symposium on*. Athens.
- Kasaju, A. (2013). Analysing an automative testing process with evidence-based software. *Information and Software Teachnology, 1237-1259*.
- Kehua, S., Jie, L., & Hongbo, F. (2011). Smart City and the Applications. *Electronics, Communications and Control (ICECC), 2011 International Conference on*.
- Krishnamachari, B., & Ordonez, F. (2003). Analysis of energy-efficient, fair routing in wireless sensor networks through non-linear optimization. *Vehicular Technology Conference, 2003. VTC 2003-Fall. 2003 IEEE 58th, 5, 2844 - 2848*.
- Liyanage, C., & Marasinghe, A. (2013). Planning Smart Meal in a Smart City for a Smart Living. *Biometrics and Kansei Engineering (ICBAKE), 2013 International Conference on*. Tokyo.
- Lyman, F. (2009). *Pro Zend Framework Techniques: Build a Full CMS Project*. Estados Unidos: The Zend Press Series.
- Peng, H., Wang, J., Han, Y., & Zhao, Q. (2012). Novel WSN-Based Residential Energy Management Scheme in Smart Grid. *International Conference on Information Science and Technology*.
- Pilone, D., & Pitman, N. (n.d.). Retrieved enero Jan 10, 2014, from <http://www.it-ebooks.info/book/154>
- Pulido A, G. J. (2001). *Modelos Eeconométricos*. Madrid: Pirámide.
- Rasmussen, C., & Dara, R. (2014). Recommender Systems for Privacy Management: A Framework. *High-Assurance Systems Engineering (HASE), 2014 IEEE 15th International Symposium on*. Miami Beach, FL.
- Riliskis, L., & Osipov, E. (2013). Symphony: Simulation, emulation, and virtualization framework for accurate WSN experimentation. *Software Engineering for Sensor Network Applications (SESENA), 2013 4th International Workshop on*, 1-6.

- Rosen, K. (2004). *Matemática discreta*. Nueva York: Mc Graw- Hill.
- Royce, W. (1970, Agosto). Managing the development of large software. *IEEE*, 26, 1-9.
- Saha, S., & Matsumoto, M. (2007). A framework for disaster management system and WSN protocol for rescue operation. *TENCON 2007 - 2007 IEEE Region 10 Conference*, 1-4.
- Shafer, W., Prieto, R., & Matsumoto, M. (n.d.). *Software Reusability*. 1994: Ellis-Horwood Ltd.
- Vergara Carabeño, M. A. (Junio de 2013). *Redes de Comunicaciones en Smart Cities*.-Trabajo Tesis de Maestría. Castilla, España: Universidad de Castilla - La Mancha.
- Zhao, F., & Guibas, L. (2004). *Wireless Sensor Network: An information processing approach*. San Francisco: Morgan Kaufmann Publishers.



## Pedestrian systems design

### Diseño de los sistemas peatonales

Lindsay Álvarez Pomar\*, Germán Méndez Giraldo\*\*, Natália Martins Gonçalves\*\*\*

**Fecha de recepción:** June 10th, 2014

**Fecha de aceptación:** November 4th, 2014

**Citation / Para citar este artículo:** Álvarez Pomar, L., Méndez Giraldo, G., & Martins Gonçalves, N. (2014). Pedestrian systems design. *Revista Tecnura*, 18 (Edición especial doctorado), 124–135. doi: 10.14483/udistrital.jour.tecnura.2014.DSE1.a11

#### ABSTRACT

Transport systems as components of mobility systems have become key elements for the development of cities. However, most efforts have been made to improve on motorized transport systems, leaving out the non-motorized ones including the pedestrians. Lately there has been a clear trend worldwide regarding awareness about the importance of walking to raise levels of quality of life, especially in cities. This phenomenon, coupled with the shortage of parking in relation to the amount of vehicles, fuel costs, and other considerations has shifted attention to pedestrian systems. This paper presents a discussion of the context in which pedestrian systems are immersed, how they are defined, what is their significance, how they are designed and finally, concludes on what is the trend in their representation and what are the “gaps” or lacks in modeling of these systems. This paper concludes that there is a tendency to analyze pedestrian systems with a microscopic vision and to neglect their recognition as transport systems.

**Keywords:** Computational cultural modelling, Sociotechnical systems, System analysis and design, System identification, Urban development.

#### RESUMEN

Los sistemas de transporte como componentes de los sistemas de movilidad se han convertido en elementos clave para el desarrollo de las ciudades. Sin embargo, la mayoría de los esfuerzos se han enfocado a mejorar los sistemas de transporte motorizado, dejando de lado a los no motorizados, como el sistema peatonal. Recientemente se nota una clara tendencia en todo el mundo con respecto a la concientización sobre la importancia de caminar para elevar los niveles de calidad de vida, especialmente en las ciudades. Este fenómeno, unido a la escasez de estacionamientos con respecto a la cantidad de vehículos y gastos de combustible, entre otros, ha desplazado la atención hacia los sistemas peatonales. Este artículo presenta una discusión del contexto en el que están inmersos los sistemas peatonales,

\* Master in Industrial Engineering. Professor and Researcher at Universidad Distrital Francisco José de Caldas, Bogotá-Colombia. E-mail: [lalvarez@udistrital.edu.co](mailto:lalvarez@udistrital.edu.co)

\*\* Doctorate in Technical Sciences; Master in Industrial Engineering. Professor and Researcher at Universidad Distrital Francisco José de Caldas, Bogotá-Colombia. E-mail: [gmendez@udistrital.edu.co](mailto:gmendez@udistrital.edu.co)

\*\*\* PhD in Transport Planning and Urban Development. Master in Industrial Engineering – Transport and Logistics. Professor and Researcher at Universidade do Extremo Sul Catarinense, Criciúma, Brazil. E-mail: [ngo@unesb.net](mailto:ngo@unesb.net)

cómo se definen, cuál es su significado, la forma en que se diseñan y, finalmente, se analiza la tendencia en su representación y las “brechas” o carencias en el modelado de estos sistemas. Se concluye que existe una tendencia a analizar los sistemas

peatonales con una visión microscópica y descuidar su reconocimiento como sistemas de transporte.

**Palabras clave:** análisis y diseño de sistemas, Desarrollo urbano, Identificación de sistemas, Modelamiento computacional de la cultura, Sistemas sociotécnicos.

## INTRODUCTION

The fast urbanization has also raised traffic densities in the cities. As a consequence, people and transport carrier have been pushed to demand on trip time to reach their destination. That traffic has taken the attention of public and private authorities in the developed as well in the developing countries (Carsten, Sherborne & Rothengatter, 1998), because the intensification of urban life and the markets, transport has become an inherent system to humans. This phenomenon has moved international organizations that are coming together, combining efforts to make joint analysis in searching for solutions for the design of public policies in order to support the development that can reach the needs of cities, regions and countries.

The transformations in the urban environments have made people use different transport modes, including pedestrian transport, an intrinsic alternative to human beings, which has gained especial attention because of its contribution to the standard of living in cities. As a result, both researchers and planners have proposed discussions and studies on the issue in order to deliver ideas to support decision-making processes on public policies and planning. This paper aims to give an overview of the context in which pedestrian system is presented, as well as its definition, what is its importance, how they are conceived, what means its representation. The conclusions lead with the trends for the representation of pedestrian systems in the transport network and point out the possible “gaps” where planning need to work on proposing advancements for pedestrian systems.

## TRANSPORT SYSTEMS

OECD and the International Transport Forum established a Joint Center for Transport Research in 2004 in order to investigate all means of transport to support policymaking in member countries and contribute to the ministerial meeting of the Forum (OCDE, 2011). Furthermore, the European Union mentioned in their announcements that transport is without any doubts an important economic growth factor; however, it is also associated with most of the environmental, economic and social costs generated today, particularly those referring to traffic accidents. This is a reason why the World Health Organization (WHO) declared from 2011 to 2020 the decade for the prevention of accidents and together with the Pan American Health Organization (PAHO) adopted an action plan on road safety to prevent injuries caused by traffic.

### Definition

The Mexican Institute of Transport, after doing a broad review of the discussions on the issue, defines transport as a process, which is a set of actions that is constantly repeated; it aims at changing the position in space of people and/or things, that its utility is greater than elsewhere. It is a complex phenomenon, with special features, even also dependent on different approach to analysing (Islas & Zaragoza, 2007).

A transport system is made up of four interacting elements: the infrastructure, the vehicle, the operator and the regulations and rules. The first relates to the physical basis required for the transport

operation, such as roads, sidewalks, traffic lights or roundabouts (Transit Cooperative Research Program, 1999); the vehicle is the mechanism that allows the transfer of people or things; the transport operator is the person responsible for driving the vehicle; and the last, which refers to the rules and regulations, determines how to move from one place to another, regulate and standardise the operation for the actors involved in the transport services (Transportation Research Board, 2000). The traffic phenomena are a consequence, among others, of the transport operation (Islas & Zaragoza, 2007).

At the National Traffic Code of Colombia (NTCC), traffic is defined as the movement of people, animals or vehicles on a public or private road, opened to the public. Transport is defined as the movement of people, animals or things from one point to another using a physical basis to move. Based on that, it can be assured that one moves on traffic when a transport mean is available, but it is also possible to move without transport. In general, transport is multimodal, multi-sectorial, multi-problematic and multidisciplinary (Transportation Research Board, 2000). It can be said that a transport system is what allows the movement of people or things, through vehicles, operators, infrastructure and rules or regulations. Considering this point of view, it is possible to say that one can move when a type of transport is available, but also one can move without transporting anything.

### Transport representation

The transport modelling refers not only to the estimated demand of users who want to move from one place to another in the city, but it is necessary to consider its complexity, involving other variables like actors and events (Duarte, 2011). Additionally, the costs and externalities generated for users and operators (Novaes & Gonçalves, 1996) must be considered. Moreover, it might be seen not solely as a phenomenon in which the object of study is the action of users group of a transport system,

but it involves institutions, regulations and even cultural aspects that directly or indirectly affect the management of transport systems (Hensher & Button, 2005).

Beimborn & Kennedy (1996), cited by Duarte (2011), presented a list of steps for modelling transport, whose main elements are the land use, trips forecasts, the impacts of transport in land use, quality of life, etc. Land use has direct correlation with transport system in the cities (Montezuma, 2000). The modelling process makes the balance between demand and supply for specific land use and transport system (Beimborn & Kennedy, 1996). In fact, trip forecasts are the heart of transport modelling. Given its complexity, traditional methods divide a study area in travel zones (TAZ by Travel Analysis Zones). Modelling seeks to identify what are the interactions on travel occurring between a TAZ and other zones; therefore, the method dismiss trips occurring within each TAZ. This means that walking and cycling are not taken into account in the travel arrangements correlations, what is considered a major weakness of this type of models (Duarte, 2011). The following tools can be mentioned as important information technology for the representation and simulation of transportation systems: MEPLAN, INTEGRATION, IHDSM, TWOPAS, TRANSIMS, VISSIM, TEAPAC, AIMSUN, HCM/Cinema, WATSIM and CORSIM.

### PEDESTRIAN SYSTEMS

Urban mobility refers to the different displacement generated within the city through networks of local connection (Jans, 2009), that is the ability to overcome distances in the urban spaces (Vasconcellos, 2001). According to Gonçalves, urban mobility is explained by “the movement of people and goods in the space by using the available transport infrastructure and technology in order to access city life” (Gonçalves 2014, p. 264). In fact, the mobility system consists of three transport systems: motorised and non-motorised vehicles, and walking (Transportation Research Board, 2000). Pedestrian

systems allow people to displace to access to the different places they need in their daily life, such as working places and education institutions (OPS-WHO, 2011).

Furthermore, mobility systems consist of several transport systems, which correspond to each of transport modes: terrestrial, maritime and air modes (Gonçalves & Silva, 2007). In this case, the pedestrian system is part of the terrestrial mode and specifically within the urban transport system, but in general, there are pedestrians also in the rural area.

The objective of urban transport is defined in the transport planning manual of the city of Bogotá as aiming “permitir la movilización de bienes y personas en condiciones preestablecidas de precio, confort y seguridad en el menor tiempo posible”<sup>1</sup> (Secretaría de Tránsito y Transporte, 2005). These displacements can be made with or without a mean of transport. In fact, in the case of pedestrian systems, the vehicle and the transport operator may be actually associated with the pedestrian itself. In conclusion, we can say that a pedestrian system is a transport system that has as vehicle and operator the pedestrian itself.

### Pedestrian systems importance

In practice, as the cities become more geographically widespread, pedestrian movements also increase (for example, to access mass transit systems or to park vehicles in allowed areas). Pedestrian system is desirable, among other reasons, to prevent high traffic densities of private vehicles and congestions. Furthermore, people are becoming aware that walking improves their quality of life. It is also true that in any society there are individuals whose economic conditions make walking the only option for them to move. The growth of pedestrian movement and volumes in certain areas of cities can cause pedestrian congestion, affecting vehicular traffic in interaction points of pedestrians-vehicles. In fact,

<sup>1</sup> In English: to allow movement of goods and people under predetermined conditions of price, comfort and safety in the shortest possible time.

in the report on pedestrians, road safety and space of 2011 it was highlighted the importance of walking and the need for policies that promote pedestrian systems (OECD, 2011).

Data of 2007 shown that the adjusted mortality rate by traffic injuries in the world was 18.8 per 100,000 population, while in the Americas was 15.8 per 100,000 population (OCDE, 2011). The numbers for the Americas point out that 39% of people who die in the region due to road traffic injuries are vulnerable road users (pedestrians, cyclists and motorcyclists), while 47% are occupants of motorised vehicles (OCDE, 2011). In the United States and Canada the adjusted mortality rates caused by traffic injuries have dropped considerably in the last 30 years: the features are about 13.9/100,000 population and 8.8 / 100,000, respectively. In South America, only Colombia recorded a decrease in the mortality rate in 10 years till 2007; two countries in the Caribbean, the Bahamas and Jamaica, have reported similar trends in more recent periods.

### Elements of pedestrian systems

The elements of pedestrian systems can be analysed focussing on the levels strategic, tactical and operational, considering the interrelation of the levels and the impacts on decision of each level. At the strategic level may initially identify infrastructure-related decisions, the budget, public policies and regulations (Gonçalves, 2014). At the tactical level, we can identify the campaigns, fines applied for irregularities and information. In the operational level are essentially pedestrians relations. The pedestrian systems elements and their decision-making process can be identified at the strategic, tactical and operational levels, considering that these levels are correlated. At the strategic level it is identified the decisions related to infrastructure, budget and regulations (Gonçalves, 2014). At the tactical level are campaigns, information and fines. The pedestrian's interrelations can basically be observed at the operational level.



The abstractions of pedestrian systems made by various authors in different publications (Venuti & Bruno, 2007; Seyfried *et al.*, 2006; Leden, Garder, & Johansson, 2006) have given the instruments for modelling at specific issues within the system, in general supporting decision-making at operational level. Furthermore, transport systems have certain elements that enable their functionality and their inner-inter relationships. These elements are essential for planning and modelling; it is what supports the design of sustainable networks (Gonçalves & Silva, 2007; Novaes & Gonçalves, 1996). The identification of pedestrian systems elements become more important considering there is a lack of formal definition of them, despite being recognized as subsystems of mobility systems. Prior to identify and describe these elements a description of system's actors is considered.

People who affect or are affected (stakeholders) by the pedestrian mobility systems are pedestrians, decision makers, owners of public spaces and vehicle users (motorised, non-motorised, public, private, etc.). According to the Road Transportation Authority (RTA), guidelines for planning pedestrian mobility, a pedestrian is considered any person who walks, including people who ride wheelchairs motorised or not, that cannot travel more than 10 km/h at floor level; people pushing motorised or non-motorised chairs, and people using recreation tools or wheeled toys (RTA, 2002).

According to RTA (2002), decision must be taken at the Local Governments (planning and management authorities) who can delegate the task of planning pedestrian mobility. For one hand, commercial and services areas normally see as desirable the facilities for pedestrian accessibility to their stores and buildings. On the other hand, vehicle users see themselves affected by the interaction with pedestrians through different ways, usually associated with having to share the roads at pedestrian crossings or violations of signalling and traffic regulations by involved parts.

The elements of pedestrian systems structure (the arrangement and the position of the parts

within a whole), stands out as the main framework to a regulatory body, which is called city. The city is responsible for developing policies, overall design and makes modifications to the pedestrian system, seeking to ensure its sustainability, development and evolution (Mobility Departments or Local Councils).

The City has the planning, management and control of mobility system, infrastructure and regulations related to pedestrians. Moreover, the city is responsible for the design and implementation of campaigns to improve the performance of pedestrian system. These may be type informative (looking for informing people about certain events, features, etc.), preventive (looking for avoiding undesirable actions or phenomena) and corrective (looking to change certain behaviour or trends that is not desirable for the system).

Fines are also part of the mobility system (Ipsos Napoleón Franco, 2012). They can be type administrative or criminal sanctions seeking to punish non-compliance. The city conducts traffic control (Transportation Research Board, 2000) through different ways even make use of the infrastructure and regulations that might be executed by the police or traffic surveillance personal. The pedestrian mobility has as its protagonist pedestrians, which interact with each other, vehicles and infrastructure (Jerez & Torres, 2011) that make displacement to almost any place. In especial, the displacements can be classified into those that are made by pedestrian areas such as sidewalks; those made to cross through permitted areas (Transit Cooperative Research Program, 1999), such as zebra crossings; and those made to cross not allowed areas.

The vehicular mobility has drivers and they have vehicles. Vehicle is seen as a passive entity, managed by the driver. Nevertheless, it has a behaviour that depends on its technical and mechanical condition and how it is conducted. The driver behaviour depends on the environment, people interrelations at specific moment and the physical place in where they are.

Infrastructure is a component of the mobility system that refers to the physical structure of a



system. Infrastructure can be changed by the City aiming to respond to changings of pedestrian traffic (Secretaría de Tránsito y Transporte, 2005) or to raise traffic safety and comfort reflected in numbers of accidents, fines or risks that pedestrians are exposed. The infrastructures in the City constraint behaviour of vehicles and pedestrians as it put restrictions on the physical spaces in which they move. These restrictions seek the comfort of the actors and their safety within the framework of rules and policies (Transit Cooperative Research Program, 1999). In general, the infrastructure can be divided into pathways and signalling (Jerez & Torres, 2011). The first contains gazebos and bridges; additionally, the pathways can be vehicular traffic lanes, cycle routes and footpaths. The second, signalling, consists of vertical and horizontal signals and traffic lights. The last component of pedestrian system structure is regulations (Transit Cooperative Research Program, 1999), which means International, National and City regulations regarding pedestrians and vehicles. Overall, regulations restrict the behaviour of pedestrians, drivers and vehicles, at different levels, looking to generalise and standardise this behaviour so that they can preserve the life and comfort of the actors in the system.

### Analysis focus

Pedestrian systems have been analysed based on different approaches. Mostly the studies focus on some aspects or elements of the system; therefore, delivering partial results for the analysis, and does not give a global view of the entire system. Among these approaches it can be considered mainly the intelligent transport systems, academic studies to represent specific situations on pedestrian behaviour, technical standards and rules for dimensioning elements of pedestrian systems, and city mobility plans, especially those dedicated to pedestrian mobility.

The “Intelligent Transportation Systems” (ITS) are part of a research devoted to propose intelligent

solutions to mobility problems by analysing the relationship between infrastructure and vehicles in order to affect it through the use software, hardware, devices and algorithms to improve the welfare and efficiency of this relationship. The focus given by studies using ITS considers people from the point of view of safety and accessibility; however, it is not common that studies take into account pedestrians interactions, within their own logics and needs. The solutions proposed by ITS are not based on a comprehensive view of the problem, although efforts have been made to expand them, for example through the fusion of models and data (W.-D. Yang & Wang, 2012). The literature on ITS can be classified into three groups: those related to electronic development, to algorithms and to infrastructure. The first are for example alarms, traffic lights, sensors, GPS, among other developments, such as the use of ISA (Intelligent Speed Adaptation) in vehicles (Ma & Andréasson, 2005). On the issue of infrastructure ITS solutions are related to bridges, intersections and design, among other studies. And on the subject of algorithms, those solutions are related to traffic light synchronization (Chen, Chen, Lin, & Mao, 2007). There are other studies where ITS approach has also explicitly included pedestrians, such as a proposal of tools to improve pedestrian traffic without affecting vehicular movement (Carsten *et al.*, 1998); also it was developed a framework for the analysis and evaluation of safety for vehicles, including pedestrians (Kulmala, 2010) crash risk and consequence, (2. Likewise, it was presented a study on the impact of installing counters showing how much time is left for pedestrians to cross the streets (Keegan & O’Mahony, 2003). Overall, the ITS approach has not comprehensively taken into account pedestrian systems, but have focused on evaluating the response of pedestrians and vehicles to the implementation of tools and technologies.

The second approach for the analysis of pedestrian systems relates to academic studies, which in almost all cases have attempted to respond to specific problems and have made adaptations of

techniques, usually mathematical type to represent pedestrian systems. One of the techniques used for making decisions regarding pedestrian mobility simulation is especially used to represent the behaviour of pedestrians in specific situations, rather than to make macro representations of pedestrian system.

Most studies address some particular feature of pedestrians, such as the modelling of the phenomena affecting their movements (Löhner, 2010); individual behaviour and the behaviour due to the interaction with other pedestrians (Zhang & Han, 2011); displacement (Jian, Lizhong, & Daoliang, 2005; Suma, Yanagisawa, & Nishinari, 2012; Ezaki, Yanagisawa, Ohtsuka, & Nishinari, 2012; Gotoh, Harada, & Andoh, 2012; Tian, Huang, & Liu, 2010); definition of criteria to evaluate the relation of door-to-door displacement and infrastructure (Gonçalves, 2012); social strength, speed and density in the groups (Seyfried, Steffen, & Lippert, 2006); and the types of pedestrians in crosswalks (J. Yang, Deng, Wang, Li, & Wang, 2006).

With regard to the representation of pedestrians flow, there have been modelling for different features such as a simulation study of bottlenecks in areas with high pedestrian traffic (Cepolina, 2009); pedestrian movement modelling differentiating restricted and unrestricted systems, including various features of pedestrians to make more accurate models (Robin, Antonini, Bierlaire, & Cruz, 2009; Antonini, Bierlaire & Weber, 2006); and a stochastic model to represent the dynamics of pedestrians flow considering psychophysical and psychological characteristics (Kholshvnikov, Shields, Boyce, & Samoshin, 2008). Other examples are: A model of pedestrian flow with conservation of mass and moments (Jiang & Zhang, 2012); integration of mathematical models with a simulation with a platform called GETRAM and a traffic assignment software (Montero, Codina, & Barcel, 2001); and finally, a microscopic simulation model of two levels (Xi & Son, 2012). Although the mentioned tools considered certain features to represent the pedestrian flow, it is not

visible an overview of pedestrian systems and the integration of the features what was previously identified in other studies.

The movement of pedestrian groups was modelled, performing their behaviour inter and intra group (Löhner, 2010); pedestrian movement using two axis (Jian *et al.*, 2005); individual behaviour and behaviour due to interaction with other pedestrians (Zhang & Han, 2011); anticipation of pedestrians (prediction if the place where one intends to move will be busy or not) (Suma *et al.*, 2012); repulsion towards other pedestrians (Ezaki *et al.*, 2012); back-flow of pedestrians in congested systems (Gotoh *et al.*, 2012); the way the route is chosen, based on experience (Tian *et al.*, 2010); social force, speed and pedestrian density (Seyfried *et al.*, 2006); pedestrians types in crosswalks: the law-abiding and the opportunists (Yang *et al.*, 2006); characterization of pedestrian movement to simulate their behaviour (Löhner, 2010). Observing these studies, it is seen that each focuses on specific phenomena that represents partial features and do not evaluate their interrelations within the whole system.

Furthermore, some studies used simulation trying to make the representations in a more comprehensive manner. For example, a microscopic simulation model took into account not only perpendicular crosswalks, but it considered also various phenomena such as bottlenecks and route preferences (Guo & Tang, 2012); moreover, a model for estimating performance measures of pedestrian systems using queuing theory (Lovas, 1994). It was developed a waiting time model for pedestrians aiming to minimize bottlenecks, used to measure the effectiveness of evacuations (Fang *et al.*, 2011); a simulation model that takes into account the interaction with vehicles and pedestrians using cellular automata (Tian *et al.*, 2010); a micro simulation model based on agents having three levels (López-Neri, Ramírez-Treviño, & López-Mellado, 2010); and a model of micro simulation and network optimization to evaluate time and cost for vehicles and pedestrians by varying the timing of traffic lights (Ishaque & Noland, 2007).

However, despite these studies show a more global view, they are limited to the operational level of pedestrian systems.

Other studies presented tried to include more variables than those listed above. For instance, there are some proposing to provide inputs from the use and the adaptation of techniques for the analysis of pedestrian systems. Unfortunately, these studies presented the same shortcomings mentioned above. For example, an autonomous multi-human simulation (Shao & Terzopoulos, 2007); a multilevel simulation with multi-agent holonic systems and scheduling engine Gaud et al, 2008). A model using dynamic spatial discretization (Antonini *et al.*, 2006); a stochastic model to represent the dynamics of the flow of pedestrians (Kholshchikov *et al.*, 2008); and a model with Petri network to simulate the timing of traffic lights at an intersection (Dotoli & Fanti, 2006).

It is possible to affirm that simulation has been widely used for the representation and analysis of pedestrians, especially from the micro simulation approach. However, it has been used only in specific situations and there is no evidence of its use with systemic approaches. In fact, the commercial software available for pedestrian's simulations is focus primarily, towards the operational level. Despite the improvements of these computational tools, mostly they provide support for making operational decisions and in a few cases for tactical decision-making, but a comprehensive view is not evident in decision-making processes relating to pedestrian systems. Nevertheless, there are studies that have contributed significantly to the characterization of pedestrians (Tom & Granié, 2011; Jesins, 1973; Hatfield & Murphy, 2007; Cambon de Lavalette *et al.*, 2009; Milligan, Poapst, & Montufar, 2012). One advantage of the available studies is that they offer lots of information about the behaviour of pedestrian systems, including identification of influential variables, even these information are biased.

The third approach is the analysis of the technical standards for modelling pedestrian systems. The

Highway Capacity Manual (HCM) is a reference publication broadly known and used by decision makers in transport systems. It contains concepts, guidelines and procedures for calculating capacity and services quality of various elements of road network and pathways, and it evaluates the impacts of mass transit, pedestrians and bicycles in the performance of these systems. The analysis presented in the HCM manual focus primarily to the vehicles; so that does not explicitly identify all the elements of transport systems. It identifies three basic elements that affect driving a vehicle and the driver environment. Within the elements of 'environment' are pedestrians, bicycles and buses, as well as physical spaces. In fact the HCM Manual proposes the aggregation of individual elements of urban systems for the analysis (Transportation Research Board, 2000).

In Colombia there is the 'Planning and Design Handbook' for traffic and transport management developed by the Colombian Bureau of Transport. It aims to strengthen the planning, design, implementation and monitoring of studies and projects, developed to the city of Bogotá (Secretaría de Tránsito y Transporte, 2005). Furthermore, there are some specialised manuals and pedestrian systems publications. Within these manuals is the Colombian 'Urban Pedestrian Infrastructure Manual', developed by Universidad Pedagógica y Tecnológica de Colombia. The manual presents the most important elements of pedestrian systems infrastructure based on an extensive literature review and among them is the HCM (Jerez & Torres, 2011). Although it is a very valuable publication, its scope does not extend beyond the characterization of infrastructure.

It is worth to mention studies developed in various countries, like the guidelines for designing master plans for pedestrian and bicycle mobility (Burbidge, Vyas, Julie, & Mitman, 2012); the Best Practices Manual for planning and design of pedestrian systems of Sacramento (STAQ, 2005); a handbook to orient the incorporation of pedestrian infrastructure in the transport system of the city

of Washington, USA (Otak, 1997); a book of the Roads and Traffic Authority of Australia on how to write mobility plans (Road Transportation Authority, 2002); and a handbook on how to plan and design for pedestrians, of the Department of Transportation, city Western-Australia (Department of Transport Western Australia, 2012). The publications mentioned concentrates the discussion on infrastructure and other issues such as policies; however, these studies does not present a discretionary analysis of the pedestrian systems elements shown in the previous section.

The study identified various pedestrian mobility plans developed in different cities. These plans also provide an approach for the analysis and representation of pedestrian systems; however, as it was seen in the handbooks, there are certain elements of pedestrian systems that are not taken into account in all publications. Among the most cited by technicians and literature were considered the San Diego, Madrid, León, Ourense, New York, Leon, Dublin, Grangegorman and Eugene. The first feature analysed refers to mobility plans that is specifically dedicated to pedestrian system or only includes pedestrians' elements; the second one was the current state (shows whether the plans take into account the elements and/or the statistics of the system at the time of planning). In the other items (goals, strategies and actions, cycling, infrastructure, budget, signalling, campaigns, fines, safety, education, diffusion, evaluation), it was only revised the recognition of the elements in the plans, no matter how deeply they were analysed.

The results of the mobility plans analysis shown they do not cover all elements of pedestrian systems; moreover they do not present the relationships between them. It was observed that the plans lack an integrated and comprehensive view. Furthermore, it is necessary to explicit internal correlations of the systems elements, the orientation about the feedback relationships and the expansion and revision for the plans, in order to propose more integrated and effective plans for cities.

## FINAL CONSIDERATIONS

The different approaches of pedestrian systems studied have in common the statements for decision-making on infrastructure. Although some of them take into account the behaviour of pedestrians, as key players, only do so with respect to certain characteristics, usually those related to travel. However, other actors in the system as decision makers or those doing the monitoring are not taken into account, except in some cases of mobility plans and handbooks. Also, the influence of other features of pedestrian systems such as budget, campaigns, etc., does not appear on the contents of the analysed studies. Moreover, it is worth to highlight the need for a systemic view of the dynamics of pedestrian's behaviour.

The current state analyses indicate that the representation of pedestrian systems is oriented to operational features and lacks a systemic view of pedestrian mobility. It was observed on the studies a tendency to microscopic analysis, which is far from the classical representations of transport systems. Apparently the pedestrian system has not been recognized in practice as an important transport system for cities such as the vehicular system or the public transport system. It is only since the last decade that specific plans for pedestrian mobility start to be presented for some urban areas.

Finally, in the studies analysed it was observed a clear influence of traffic accident statistics in decision-making, indicating a reactive behaviour of technicians and decision makers, regardless a deeper prospective analysis or forecasts based on actors behaviour and the correlations of influence and feedback between elements of the pedestrian system and its environment.

## FUNDING

This paper was developed within the research project "Collective intelligence model of pedestrian systems" funded by the *Centro de Investigaciones*



y Desarrollo Científico de la Universidad Distrital Francisco José de Caldas, Bogotá, Colombia.

## REFERENCES

- Antonini, G., Bierlaire, M. & Weber, M. (2006). Discrete choice models of pedestrian walking behavior. *Transportation Research Part B: Methodological*, 40(8), 667-687.
- Beimborn, E. & Kennedy, R. (1996). *Inside the Blackbox: Making transportation models work for livable communities*. Milwaukee. Recuperado de <http://www4.uwm.edu/cuts/blackbox/blackbox.pdf>
- Burbidge, S., Vyas, M., Julie, B. & Mitman, M. (2012). *Utah bicycle and pedestrian master plan design guide*. Utah. Recuperado de [http://walkbikeplan.com/wp-content/uploads/2012/03/UDOH-Bike-Ped\\_Final\\_11-1-11.pdf](http://walkbikeplan.com/wp-content/uploads/2012/03/UDOH-Bike-Ped_Final_11-1-11.pdf)
- Cambon de Lavalette, B. et al. (2009). Pedestrian crossing decision-making: A situational and behavioral approach. *Safety Science*, 47(9), 1248-1253.
- Carsten, O. M. J., Sherborne, D. J. & Rothengatter, J. A. (1998). Intelligent traffic signals for pedestrians: Evaluation of trials in three countries. *Transportation Research Part C: Emerging Technologies*, 6, 213-229.
- Cepolina, E. M. (2009). Phased evacuation: An optimization model which takes into account the capacity drop phenomenon in pedestrian flows. *Fire Safety Journal*, 44(4), 532-544.
- Chen, Z., Chen, S., Lin, L. & Mao, B. (2007). Design and simulation of signal phase for pedestrians' twice crossing at large signalized intersections. *Journal of Transportation Systems Engineering and Information Technology*, 7(4), 57-65.
- Department of Transport Western Australia. (2012). *Planning and designing for pedestrians: guidelines*. Recuperado de [http://www.transport.wa.gov.au/mediaFiles/active-transport/AT\\_WALK\\_P\\_plan\\_design\\_pedestrians\\_guidelines.pdf](http://www.transport.wa.gov.au/mediaFiles/active-transport/AT_WALK_P_plan_design_pedestrians_guidelines.pdf)
- Dotoli, M. & Fanti, M. P. (2006). An urban traffic network model via coloured timed Petri nets. *Control Engineering Practice*, 14(10), 1213-1229.
- Duarte, E. (2011). *Desarrollo de un modelo para el sistema de transporte público de la ciudad de Bogotá, D.C., basado en dinámica de sistemas*. Universidad Distrital Francisco José de Caldas, Bogotá, Colombia.
- Ezaki, T., Yanagisawa, D., Ohtsuka, K. & Nishinari, K. (2012). Simulation of space acquisition process of pedestrians using Proxemic Floor Field Model. *Physica A: Statistical Mechanics and Its Applications*, 391(1-2), 291-299.
- Fang, Z., Li, Q., Li, Q., Han, L. D. & Wang, D. (2011). A proposed pedestrian waiting-time model for improving space-time use efficiency in stadium evacuation scenarios. *Building and Environment*, 46(9), 1774-1784.
- Gaud, N., Galland, S., Gechter, F., Hilaire, V. & Koukam, A. (2008). Holonic multilevel simulation of complex systems: Application to real-time pedestrians simulation in virtual urban environment. *Simulation Modelling Practice and Theory*, 16(10), 1659-1676.
- Martins, N. (2014). *Integrated urban transport planning: Accessible cities towards individual and collective development*. Eberhard Karls Universität Tübingen, Germany.
- Martins, N. (2012). *Bus Rapid Transit: level of service analysis of pedestrian itinerary and the BRT station towards user-friendly accessibility and universal design*. In: 13th. Conference on Mobility and Transport for Elderly and Disable Persons. TRANSED 2012, New Delhi.
- Martins, N., Morato, R., Rothfuss, R. (2012). A organização e a ocupação do espaço urbano nas cidades do Século XXI: impactos das políticas públicas do Brasil dos anos 1990 no direito de ir e vir no ambiente local. *Amicus Curiae*. V.9, N.9. UNESCO, Criciúma. Available at: <http://periodicos.unesc.net/index.php/amicus/article/viewFile/875/829> (Retrieved in 05.04. 2014).
- Martins, N. Silva, S. C. R. (2007). Gestão conjunta do transporte e trânsito em municípios integrados ao Sistema Nacional de Trânsito: o caso do Município de Criciúma, Brasil. In: 16º Congresso Brasileiro de Transporte e Trânsito. ANTP, Maceió. Available at:



- <http://portal1.antp.net/site/bbtc/cng/Lists/cngr16/prstc.aspx> (Retrieved in 14.03.2014).
- Gotoh, H., Harada, E. & Andoh, E. (2012). Simulation of pedestrian contra-flow by multi-agent DEM model with self-evasive action model. *Safety Science*, 50(2), 326-332.
- Guo, R.-Y. & Tang, T.-Q. (2012). A simulation model for pedestrian flow through walkways with corners. *Simulation Modelling Practice and Theory*, 21(1), 103-113.
- Hatfield, J. & Murphy, S. (2007). The effects of mobile phone use on pedestrian crossing behaviour at signalized and unsignalized intersections. *Accident; Analysis and Prevention*, 39(1), 197-205.
- Hensher, D. & Button, K. (Ed.) (2005). *Handbook of transport modelling*. Netherland: Pergamon.
- Ipsos Napoleón Franco. (2012). Segundo estudio de comportamiento y seguridad vial. Recuperado de <http://fpv.org.co/images/repositorioftp/fpv-ii%20estudio%20vial.pdf>
- Ishaque, M. M. & Noland, R. B. (2007). Trade-offs between vehicular and pedestrian traffic using micro-simulation methods. *Transport Policy*, 14(2), 124-138.
- Islas, V. & Zaragoza, M. L. (2007). *Análisis de los sistemas de transporte* (307). Recuperado del sitio del Instituto Mexicano del Transporte: <http://www.imt.mx/archivos/Publicaciones/PublicacionTecnica/pt307.pdf>
- Jans, M. (2009). Movilidad urbana: En camino a sistemas de transporte colectivo integrados. *AUS(Valdivia)*, 6, 6-11.
- Jerez, S. & Torres, L. (Ed.) (2011). *Manual de diseño de infraestructura peatonal urbana*. Tunja: UPTC.
- Jesins, M. (1973). Response of pedestrian to traffic challenge. *Transportation Research*, 8, 71-74.
- Jian, L., Lizhong, Y. & Daoliang, Z. (2005). Simulation of bi-direction pedestrian movement in corridor. *Physica A: Statistical Mechanics and Its Applications*, 354, 619-628.
- Jiang, Y. & Zhang, P. (2012). Modeling and simulation of pedestrian flow through hydrodynamics. *Procedia Engineering*, 31(2011), 1039-1044. doi:10.1016/j.proeng.2012.01.1139
- Keegan, O. & O'Mahony, M. (2003). Modifying pedestrian behaviour. *Transportation Research Part A: Policy and Practice*, 37(10), 889-901.
- Kholshevnikov, V. V., Shields, T. J., Boyce, K. E. & Samoshin, D. A. (2008). Recent developments in pedestrian flow theory and research in Russia. *Fire Safety Journal*, 43(2), 108-118.
- Kulmala, R. (2010). Ex-ante assessment of the safety effects of intelligent transport systems. *Accident; Analysis and Prevention*, 42(4), 1359-1369.
- Leden, L., Gårder, P. & Johansson, C. (2006). Safe pedestrian crossings for children and elderly. *Accident; Analysis and Prevention*, 38(2), 289-294. doi:10.1016/j.aap.2005.09.012
- Löhner, R. (2010). On the modeling of pedestrian motion. *Applied Mathematical Modelling*, 34(2), 366-382.
- López-Neri, E., Ramírez-Treviño, A. & López-Mellado, E. (2010). A modeling framework for urban traffic systems microscopic simulation. *Simulation Modelling Practice and Theory*, 18(8), 1145-1161.
- Lovas, G. (1994). Modeling and simulation of pedestrian traffic flow. *Transportation Research Part B: Methodological*, 28(6), 429-443.
- Ma, X. & Andréasson, I. (2005). Predicting the effect of various ISA penetration grades on pedestrian safety by simulation. *Accident; Analysis and Prevention*, 37(6), 1162-1169.
- Milligan, C., Poapst, R. & Montufar, J. (2012). Performance measures and input uncertainty for pedestrian crossing exposure estimates. *Accident; Analysis and Prevention*, 50, 490-498.
- Montero, L., Codina, E. & Barcel, J. (2001). A combined methodology for transportation planning assessment. Application to a case study. *Transportation Research Part C: Emerging Technologies*, 9, 213-230.
- Montezuma, R. (2000). *Presente y futuro de la movilidad urbana en Bogotá: Retos y realidades*. Recuperado de <http://www.scribd.com/doc/32147362/Presente-y-futuro-de-la-movilidad-urbana-en-Bogota-Retos-y-realidades>
- Novaes, Antonio. G. & Gonçalves, Natália M. (1996). Returns to Escale and User's Benefits in Urban Bus

- Operation. In: VII Conference on Development and Planning in Urban Transport. *Proceedings...* CODATU: Lion, France.
- OCDE. (2011). *Peatones: seguridad vial, espacio urbano y salud*. Recuperado de <http://www.international-transportforum.org/pub/pdf/11PedestrianSumES.pdf>
- Otak. (1997). *Pedestrian Facilities Guide Book*. Recuperado de <http://www.wsdot.wa.gov/publications/manuals/fulltext/m0000/pedfacgb.pdf>.
- Roads and Traffic Authority. (2002). *How to prepare a pedestrian access and mobility plan*. Recuperado de [http://www.rms.nsw.gov.au/doingbusinesswithus/downloads/technicalmanuals/mobility-plan\\_how-to.pdf](http://www.rms.nsw.gov.au/doingbusinesswithus/downloads/technicalmanuals/mobility-plan_how-to.pdf)
- Robin, T., Antonini, G., Bierlaire, M. & Cruz, J. (2009). Specification, estimation and validation of a pedestrian walking behavior model. *Transportation Research Part B: Methodological*, 43(1), 36-56.
- Secretaría de Tránsito y Transporte. (Ed.) (2005). *Manual de planeación y diseño para la administración del tránsito y el transporte*. Bogotá: Escuela Colombiana de Ingeniería.
- Seyfried, A., Steffen, B. & Lippert, T. (2006). Basics of modelling the pedestrian flow. *Physica A: Statistical Mechanics and Its Applications*, 368(1), 232-238.
- Shao, W. & Terzopoulos, D. (2007). Autonomous pedestrians. *Graphical Models*, 69(5-6), 246-274.
- STAQ. (2005). *Best practices for pedestrian master planning and design*. Recuperado de [http://www.sacta.org/pdf/STAQC/FinalReportII\\_BPPedestrian.pdf](http://www.sacta.org/pdf/STAQC/FinalReportII_BPPedestrian.pdf) .
- Suma, Y., Yanagisawa, D. & Nishinari, K. (2012). Anticipation effect in pedestrian dynamics: Modeling and experiments. *Physica A: Statistical Mechanics and Its Applications*, 391(1-2), 248-263.
- Tian, L., Huang, H. & Liu, T. (2010). Day-to-day route choice decision simulation based on dynamic feedback information. *Journal of Transportation Systems Engineering and Information Technology*, 10(4), 79-85.
- Tom, A. & Granié, M.-A. (2011). Gender differences in pedestrian rule compliance and visual search at signalized and unsignalized crossroads. *Accident Analysis and Prevention*, 43(5), 1794-1801.
- Transit Cooperative Research Program. (1999). *Transit capacity and quality of service manual* (100) Recuperado de la página del Transportation Research Board <http://onlinepubs.trb.org/onlinepubs/tcrp/tcrp100/part%200.pdf>.
- Transportation Research Board. (2000). *Highway capacity manual*. Recuperado de [http://sjnavarro.files.wordpress.com/2008/08/highway\\_capacital\\_manual.pdf](http://sjnavarro.files.wordpress.com/2008/08/highway_capacital_manual.pdf)
- Vasconcellos et al. (2001). *Urban transport, environment and equity: The case for developing countries*. Earthscan, London.
- Venuti, F. & Bruno, L. (2007). An interpretative model of the pedestrian fundamental relation. *Comptes Rendus Mécanique*, 335(4), 194-200. doi:10.1016/j.crme.2007.03.008
- Xi, H. & Son, Y.-J. (2012). Two-level modeling framework for pedestrian route choice and walking behaviors. *Simulation Modelling Practice and Theory*, 22, 28-46.
- Yang, J. et al. (2006). Modeling pedestrians' road crossing behavior in traffic system micro-simulation in China. *Transportation Research Part A: Policy and Practice*, 40(3), 280-290.
- Yang, W.-D. & Wang, T. (2012). The fusion model of intelligent transportation systems based on the urban traffic ontology. *Physics Procedia*, 25, 917-923.
- Zhang, Q. & Han, B. (2011). Simulation model of pedestrian interactive behavior. *Physica A: Statistical Mechanics and Its Applications*, 390(4), 636-646.



## Topological challenges in multispectral image segmentation

### Retos topológicos en la segmentación de imágenes multiespectrales

José Antonio Valero Medina\*, Iván Alberto Lizarazo Salcedo\*\*, Paul Elsner\*\*\*

**Fecha de recepción:** June 10th, 2014

**Fecha de aceptación:** November 4th, 2014

**Citation / Para citar este artículo:** Rodríguez, A. A., Perdomo Orjuela, L. E., Santamaría Piedrahíta, F., & Gómez Vargas, C. A. (2014). Transient surges analysis in low voltage networks. *Revista Tecnura*, 18 (Edición especial doctorado), 136–149. doi: 10.14483/udistrital.jour.tecnura.2014.DSE1.a12

#### ABSTRACT

Land cover classification from remote sensing multispectral images has been traditionally conducted by using mainly spectral information associated with discrete spatial units (i.e. pixels). Geometric and topological characteristics of the spatial context close to every pixel have been either not fully treated or completely ignored. This article provides a review of the strategies used by a number of researchers in order to include spatial and topological properties in image segmentation. It is shown how most of researchers have proposed to perform -previous to classification- a grouping or segmentation of nearby pixels by modeling neighborhood relationships as 4-connected, 8-connected and (a, b) – connected graphs. In this object-oriented approach, however, topological concepts such as neighborhood, contiguity, connectivity and boundary suffer from ambiguity since image elements (pixels) are two-dimensional entities composing a spatially uniform grid cell (i.e. there are not uni-dimensional nor zero-dimensional elements to build boundaries). In order to solve such

topological paradoxes, a number of approaches are proposed. This review discusses how the alternative of digital images representation based on Cartesian complexes suggested by Kovalevsky (2008) for image segmentation in computer vision, does not present topological flaws that are typical for conventional solutions based on grid cells. However, such approaches have not yet been applied to multispectral image segmentation in remote sensing. This review concludes suggesting the need to research on the potential of using Cartesian complexes for multispectral image segmentation.

**Keywords:** multispectral images, segmentation, topologic space.

#### RESUMEN

La clasificación de la cobertura de la tierra a partir de imágenes multiespectrales de sensores remotos tradicionalmente se ha llevado a cabo usando principalmente la información espectral asociada con los píxeles. Las características geométricas y topológicas del contexto espacial cercano a un píxel particular han sido usualmente ignoradas o tratadas

\* Systems Engineer, master in Teleinformatics, PhD student in engineering. Associate Professor of the Universidad Distrital Francisco José de Caldas. Bogotá, Colombia. Contact: [jvalero@udistrital.edu.co](mailto:jvalero@udistrital.edu.co)

\*\* Civil Engineer, PhD in Geography. Titular Professor of the Universidad Distrital Francisco José de Caldas. Bogotá, Colombia. Contact: [ilizarazo@udistrital.edu.co](mailto:ilizarazo@udistrital.edu.co)

\*\*\* Physical Geographer. PhD in Geography. Lecturer in Geographical Information Science and Physical Geography, University of London. London, United Kingdom. Contact: [p.elsner@bbk.ac.uk](mailto:p.elsner@bbk.ac.uk)

de una manera incompleta. En este artículo se realiza una revisión de las estrategias que han sido empleadas por diversos investigadores con el propósito de incluir características topológicas y espaciales en segmentación de imágenes. La revisión muestra cómo la mayoría de ellos se han enfocado en realizar, antes de la clasificación, un agrupamiento o segmentación de los píxeles cercanos modelando las relaciones de vecindario como grafos 4-conectados, 8-conectados y (a,b)-conectados. Sin embargo, en este enfoque orientado a objetos, conceptos topológicos como vecindario, contigüidad, conectividad y límite sufren de ambigüedad ya que los elementos de la imagen (píxeles) son entidades bidimensionales que componen una retícula espacialmente uniforme. Existen algunas propuestas alternativas que

buscan resolver dichas paradojas topológicas. En este artículo se analiza cómo la representación alternativa de imágenes digitales con base en complejos cartesianos sugerida por Kovalevsky (2008), para la segmentación de imágenes de visión de computador, no presenta las paradojas topológicas de las soluciones convencionales basadas en retículas. Sin embargo, dicha propuesta no se ha explorado en los procesos de segmentación y clasificación de imágenes de sensores multispectrales. Esta revisión concluye sugiriendo la necesidad de investigar el potencial de los complejos cartesianos en la segmentación de imágenes multispectrales.

**Palabras clave:** espacio topológico, imágenes multispectrales, segmentación.

---

## INTRODUCTION

Land cover classification from remote sensing images has been traditionally conducted by using mainly spectral information associated with discrete spatial units (i.e. pixels). However, there have been a number of attempts to include both geometric and topological characteristics of the pixel neighborhood in the image analysis process (de Jong & Van der Meer, 2004). In the last decade, a number of concepts, methods and techniques for object-oriented image analysis (OBIA) have been developed and evaluated (Blaschke, 2010). The OBIA analysis process starts by grouping spectrally similar and spatially close pixels into segments. A meaningful segmentation is essential for the subsequent analysis stages (Lizarazo & Elsner, 2009).

Most of the multispectral image segmentation algorithms assume images are a continuous space similar to the real world they depict. However, the digital representation that is finally available in any computer is performed by sampling the space and discretizing reality. In addition, multi

and hyper-spectral digital images are composed of square picture elements with similar size, which is clearly inaccurate (Cracknell, 1998). This inaccuracy is present in representations of images such as 4-connected, 8-connected and -connected graphs (Rosenfeld, 1970; Kong & Rosenfeld, 1991).

Digital image processing based on representations of space that do not meet the topological axiomatic postulates causes finally geometric algorithms to be affected by paradoxes that lead to ambiguous or erroneous decisions. While it can be accepted that a raster image matches human perception to some degree, the truth is that several important concepts for image analysis, such as the connectivity of regions, their boundaries, and the adjacency between them, are ambiguously represented. This lack of topological awareness of grid-based image representation is clearly an important limitation for image analysis in computer environments (Kovalevsky, 1989). The alternative approach of digital images representation is based on complex Cartesian, suggested by Kovalevsky (2008). This concept does not present topological paradoxes that are typical of conventional



solutions based on grid cells. Kovalevsky (2006) suggested such an alternative image representation using axiomatic locally finite spaces (ALFS) based on Cartesian complexes, a type of abstract cell complexes (ACC) (Listing, 1862). It has been stated that this alternative space does not arise topological paradoxes commonly found in conventional solutions (Pavlidis, 1977; Kovalevsky, 1984). Furthermore, it has been suggested that this alternative spaces could be a strong foundation for image segmentation in computer vision (Kovalevsky, 2006). However, to the best knowledge of the author, the usage of such ALFS spaces has not been yet explored for segmentation and classification of remotely sensed multispectral images.

On the other hand, it is well known that algorithms based on geometric characteristics have high complexity since the number of possible situations to be considered increases significantly as it increases objects' dimension under evaluation (Worboys & Duckham, 2004). Additionally, another problem that arises during the implementation phase of geometric algorithms is the impossibility of having an accurate arithmetic in terms of real numbers (de Berg, Cheong, Kreveld, & Overmars, 2008). A number of authors have attempted to reduce this algorithmic complexity of geometric spaces by selecting a subset of geometrical characteristics and transforming them into combinatorial structures using oriented matroids (Whitney, 1935; Oxley, 2003; Richter-Gebert & Ziegler, 2004). Examples for complex applications that have benefitted from such approaches are counter clockwise (CC) systems (Knuth, 1992), triangulation of point sets (Pfeifle & Rambau, 2002; de Loera, Rambau, & Santos, 2010), and terrain visibility analysis (Saeedi, 2012). While algorithmic complexity is part of the research reported here, it will not be further discussed due to lengths limitations.

This article begins introducing digital image segmentation basic principles. Next, it shows several attempts for involving geometric and topologic features in image segmentation. Then, it describes

how Kovalevsky's (2008) proposal unambiguously includes topologic feature through the definition of digital topological spaces. Finally, conclusions are presented.

## DIGITAL IMAGES SEGMENTATION

Traditional image segmentation is the process of subdividing an image into smaller regions based on some notion of homogeneity or cohesiveness among groups of pixels (Grady, 2012). Regions are determined by two dual kind of methods (Brun, Mokhtari, & Domenger, 2003): (i) the edge-detection methods, and (ii) the region based segmentation methods. The former determine edges between regions and then close them in order to define a partition. The latter group pixels according to a homogeneity criterion aiming to obtain a partition of the image into homogeneous regions. The segmentation on an image  $X$  (the space domain) subdivides it, based on a function (the feature domain) defined on  $X$ , using a logic  $f$  predicate  $P$  on subsets  $S$  of  $X$  (Equation (1)) (Horowitz & Pavlidis, 1976).

$$P(S) = \begin{cases} \text{true} & \text{if there exists a constant } a \text{ such that } |f(x,y) - a| \leq e, \forall (x,y) \in S \\ \text{false} & \text{otherwise} \end{cases} \quad (1)$$

where  $e$  is a prescribed error tolerance. It should be noted that in general, for multispectral images, the space domain  $X \subset \mathbb{R}^n$  and the feature domain  $F \subset \mathbb{R}^m$ ; so  $f: X \rightarrow F$ , and  $a, e \in F \subset \mathbb{R}^m$ . A segmentation of  $X$  is a partition of  $X$  into subsets  $S_i, i = 1, \dots, m$  for some such that: (i)  $X = \bigcup_{i=1}^m S_i$ , (ii)  $S_i \cap S_j = \emptyset, \forall i \neq j$  (iii)  $P(S_i) = \text{true}, \forall i$ , and (iv),  $P(S_i \cup S_j) = \text{false}, \forall i \neq j$ ,  $S_i$  and  $S_j$  are adjacent in  $X$ . The conditions (i) and (ii) ensures that the image is partitioned into a set of regions. The condition (iii) ensures that each region is homogeneous according to the homogeneity criterion  $P$ . The condition (iv) ensures that all regions are maximal, thus that any merge of two adjacent regions produces a non-homogeneous region (Brun, Mokhtari, & Domenger, 2003). Region detection methods can be addressed by two ways (Horowitz & Pavlidis, 1976): The first one, also referred to



as merging or bottom-up, divides the image into a large number of small regions, which are then merged to form larger regions. The other one, also referred to as splitting or top-down, successively divides the image into smaller and smaller regions until certain criteria are satisfied.

The information provided by a partition may be mainly geometric or topological. The geometrical information relate to each region considered separately from the partition. The set of pixels composing one region, the region including one pixel or the boundary of a given region, may be classified as geometrical information. The topological information describe the relationships between regions. The set of regions adjacent to a given region or the set of regions included in one region belong to the topological information field (Brun, Mokhtari, & Domenger, 2003).

Image segmentation can be seen as a labeling problem (Ishikawa, 2012), taking from the image only the neighborhood topologic relationships and putting them on an undirected region adjacency graph (RAG) (Brice & Fennema, 1970; Cheevasuvut, Maitre & Vidal-Madjar, 1986; Guigues, le Men & Cocquerez, 2001) along with a set of labels. The problem is then to find the best labeling according to the criteria in the problem's requirements. An energy is a translation of the criteria into a function that evaluates how good the given labeling is. A smaller energy for a labeling means a better corresponding solution to the problem. Thus, the problem becomes an energy minimization one that can be solved using general algorithms. As minimization of such energies, in general, is known to be NP-hard, graph cuts methods utilizing the s-t min-cut algorithms known in operations research are used.

For segmentation quality assessment, it is common to use similarity metrics between a reference segmentation and the segmentation obtained, see, for example, Neubert, Herold, Meinel, & Blaschke (2008) (Lizarazo, 2014).

## PREVIOUS WORK ON TOPOLOGY PRESERVING SEGMENTATION

Kovalevsky (1989) showed how abstract cell complexes allow for implementing topological relations needed to unambiguously perform segmentation of digital images in computer vision by developing some algorithms (Kovalevsky, 2001), (Kovalevsky, 2005). However, the authors are not aware of recent studies that rigorously evaluate the appropriateness of Kovalevsky's approach.

Felzenszwalb & Huttenlocher (2004) addressed the image segmentation problem by defining a predicate for measuring the evidence for a boundary between two regions using a graph-based representation of the image (Urquhart, 1982), (Zahn, 1971) and developing a greedy algorithm. An important characteristic of the method is its ability to preserve detail in low-variability image regions while ignoring detail in high-variability regions. The evidence for a boundary between two regions is measured by comparing intensity differences across the boundary, and intensity differences between neighboring pixels within each region.

Yu *et al.* (2006) assessed the capacity of Digital Airborne Imaging System (DAIS) high resolution images and topographic data for vegetation classification. Image objects were generated using the fractal network evolution (FNEA) segmentation approach by considering spectral, textural, topographic and geometric attributes. Initially for FNEA each pixel is an image object. Then, pairwise objects are subsequently merged to form bigger objects by using as merging criterion that the average image objects heterogeneity weighted by their size in pixels should be minimized (Baatz & Schape, 2000), (Benz, Hofmann, Willhauck, Lingelfelder, & Heynen, 2004). Through a hierarchical classification scheme and a set of features selected for each vegetation category, the authors carried out a detailed classification and obtained much more accurate results than those provided by the conventional pixel-based nearest neighbor and maximum

likelihood methods. Furthermore, they claimed to achieve full correction of the salt-and-pepper effect present in the latter classification technique.

Kong, Xu, & Wu (2006) extracted land use information from a high spatial resolution image by using a multi-scale image segmentation approach. Urban land use was divided into different levels forming a hierarchical network structure, in which objects on the upper level are composed of objects in the lower level. Classification of image objects was performed based on attributes of color, shape, hierarchy and correlation characteristics between neighboring objects. Results showed that by including a variety of spectral and spatial features, it was possible to differentiate urban land use categories that cannot be separated through conventional per-pixel classification methods based on spectral data only.

Letscher & Fritts (2007) introduced a hybrid split-merge method for image segmentation based on computational geometry and topology by using persistent homology. The algorithm uses edge-directed topology to split the image into three types of regions based on Delaunay triangulations of points in the edge map. One type of region corresponds to objects of interests, and the remaining two types correspond to smaller regions that can be attached either to the first ones or form new objects themselves. Preliminary results showed a high quality image segmentation.

Johansen, Coops, Gergel, & Stange (2007) assessed the capacity of high spatial resolution satellite images to discriminate structural stages of vegetation in forest ecosystems. Based on semi-variogram (Tso & Mather, 2009) experiments, they established that the most appropriate window sizes for textural analysis were 3 x 3 and 11 x 11 pixels. They subsequently applied an object-oriented spectral and textural classification algorithm to produce a map of structural vegetation classes. The joint use of spectral and texture features improved thematic accuracy between 2% and 19% compared to the accuracy based only on spectral features.

Li & Sun (2010) proposed an “active image” segmentation method that distorts the image in order to match the so-called “initial” outlines and be able to segment multiple objects simultaneously. The deformation field was modeled using B-Spline free-form deformations. By penalizing the bending energy, they claimed to preserve both shape and local topology of objects of interest. Preliminary results, obtained using both synthetic and real images, showed that the proposed method allowed coping with low-contrast and occlusion issues that cannot be overcome using simple criteria for image segmentation.

Arbeláez P., Maire, Fowlkes, & Malik (2011) presented a unified approach to contour detection and image segmentation. To produce high-quality image segmentations, the contour detector is linked with a generic grouping algorithm consisting of two steps. In the first one, a new image transformation called the Oriented Watershed Transform (OWT) is introduced for building a hierarchical segmentation by exploiting the information in the contour signal (Arbeláez P., Maire, Fowlkes, & Malik, 2009). In the second one, using an agglomerative clustering procedure, an initial graph is built where the nodes are the initial regions. The links are the initial arcs separating adjacent regions, and the weights are a measure of dissimilarity between regions. The algorithm proceeds by sorting the links by similarity and iteratively merging the most similar regions. The process produces a tree of regions where leaves are the initial regions, the root is the entire image, and the inclusion relation orders the regions in a multiscale fashion.

Chen, Freedman, & Lampert (2011) proposed a new method for integrating image topological properties within a random field image segmentation model that does not pose topological restrictions in the energy minimization stage. Using such approach, they claimed to achieve an image segmentation that guarantees topological properties. It should be noted, however, that they used a graph-based image representation based on the

conventional (and inaccurate) 4-connected and 8-connected neighborhood relationships.

Arbeláez P., Maire, Fowlkes, & Malik (2009) proposed a bottom-up strategy improving the agglomeration using more information besides boundary mean. Using supervised machine learning techniques they predicted whether two super pixels should be merged or not. In case of obtaining features combination lacking training data, additional training examples are generated by applying an active learning paradigm at every agglomeration hierarchy level. In active learning, the algorithm determines what example it wants to learn from at each iteration, based on the previous training data. The learning process is checked for accuracy using a coarse-scale ground truth image. They report the usage of a region adjacency graph (RAG), but do not provide a special topological representation for it.

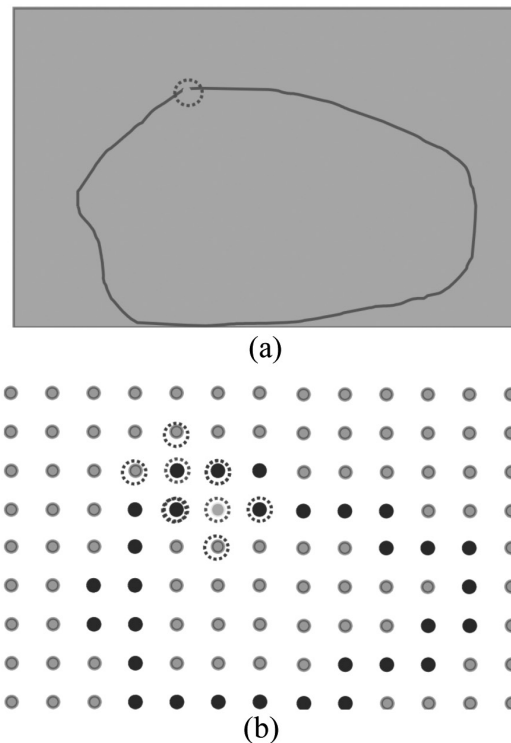
To summarize: It is apparent that, unlike the Kovalevsky's approach, no other proposed method reports the usage of a space representation meeting the axiomatic postulates for topological spaces. Other approaches assume the correctness of either the underlying image representation using the conventional grid cell model or the graph-based image representation using 4- and 8-connected connectivity.

### AXIOMATIC LOCALLY FINITE SPACES (ALFS)

The classical conception of space applied in geographic information systems (GIS) and multispectral imaging analysis is based on several concepts, including continuity. Continuity refers to the fact that a region can be always subdivided into smaller sub-regions (Stell & Webster, 2007). This concept is also known as dense sets (Worboys & Duckham, 2004). However, the digital representation is performed through space sampling that discretizes reality. As it is impossible to find a bijective function (Cantor, 1883), traditional models of digital representation of geographical phenomena (Schneider,

1977) suffer from imprecision and inaccuracy and do not include, in the particular case of the digital images, a measure of topology. These imprecisions and inaccuracies are particularly significant when geographical relationships are modeled based on concepts such as neighborhood, contiguity, connectivity and boundary. If the digital representation of those relationships is not expressed properly, GIS technology may not be able to give appropriate responses to several typical problems for remote sensing image analysis such as segmentation and classification.

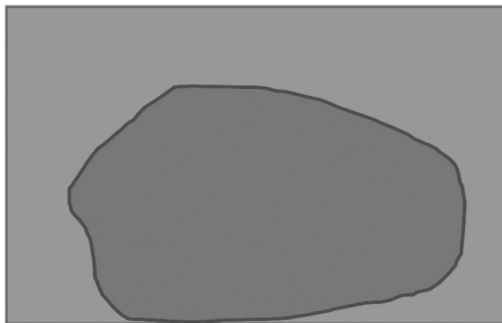
Multi and hyper spectral digital images are composed of square picture elements with similar size, which is clearly inaccurate (Cantor, 1883). This inaccuracy is present in representations of images such as 4-connected, 8-connected and -connected graphs (Rosenfeld, 1970; Kong & Rosenfeld, 1991).



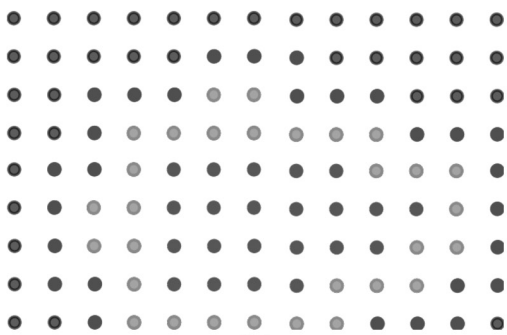
**Figure 1.** (a) Connection in a continuous space is established by removing a single element from the boundary between two sets; (b) there is a topological paradox to establish boundaries using 4-connected criteria in a conventional digital space

**Source:** own work.

Figure 1(a) illustrates that in a continuous space, withdrawing a point from the boundary between the interior and exterior sets, previously disconnected by a Jordan curve, these become connected. Figure 1(b) shows how, in a discrete space, removing the element encircled in red from the boundary (blue points) does not connect the corresponding interior and exterior sets based on the 4-connected criterion, which is illustrated using two neighborhoods (the central element of each one is depicted as a point encircled in red). Actually, it is not possible either to establish unambiguously such a connectivity using the 8-connected criterion. In this case, for the example shown, the two sets remain always connected even without removing the element under consideration from the boundary.



(a)



(b)

**Figure 2.** (a) There is a common boundary a continuous space (line in red); (b) there is a “duplicated” boundary in a discrete space (both red elements and green elements).boundary and double in a conventional digital space (b)

**Source:** own work.

Figure 2a shows how, in a continuous space, the boundaries of the interior and exterior sets, are one-dimensional and coincide perfectly (red line). Figure 2b shows how, in the conventional digital space, each of the two sets have different boundary (exterior’s boundary is red and interior’s boundary is green), and that both boundaries are two-dimensional (all the elements comprising this space are two-dimensional). These paradoxes are particularly significant for image segmentation and classification when considering topological relationships such as neighborhood, contiguity, connectivity, and boundary.

Digital image processing based on representations of space that do not meet the topological axiomatic postulates (Munkres, 1999) causes finally geometric algorithms are affected by paradoxes that lead to ambiguous or erroneous decisions. Several important concepts for image analysis, such as the connectivity of regions, their boundaries, and the adjacency between them, are not explicitly represented. This lack of topological awareness of grid-based image representation is clearly an important limitation for image analysis in computer environments (Kovalevsky, 1989, 2005)

Kovalevsky (2008) performs a compendium of his proposal for the construction of a discrete geometry based on the Cartesian complex using the definition of topological spaces based on the axiomatic locally finite spaces provided by abstract cell complexes. His proposal seeks to provide an alternative representation of space based on a digital topology which is not affected by the paradoxes found on conventional representations of images such as 4-connected, 8-connected and (a, b) – connected graphs (Rosenfeld, 1970; Kong & Rosenfeld, 1991). In his work, Kovalevsky shows how Cartesian complexes allow for implementing topological relations needed to perform digital images segmentation without any ambiguity. A digital space should be a locally finite space in which each element has a neighborhood composed finitely of several elements with various topological properties. A locally finite space (LFS) is a non-empty set



in which each element is assigned other elements, some being finite subsets. An LFS is called an axiomatic LFS (ALFS) when satisfies the following four axioms:

*Axiom 1:* For each space element there are certain subsets containing it, which are its neighborhoods. The intersection of two neighborhoods of an element is also a neighborhood of that element.

*Axiom 2:* There are space elements whose smallest neighborhood (SN) consists of more than one element.

*Axiom 3:* The frontier  $Fr(T, S)$  of any subset  $T \subset S$  is thin.

*Axiom 4:* The frontier of the frontier of a subset of an LFS is equal to the frontier of the subset.

Since the space is locally finite, there exists the smallest neighborhood (SN) for each of its elements that is the intersection of all the neighborhoods of a particular element. If one element belongs to the SN of the other, it is said that the one is *incident* (IN) to the other. An *incidence path* (IP) between a pair of elements of a subset of an LFS is a sequence of elements between the one and the other in which each pair of subsequent elements are incident. If it is possible for each pair of elements of a given subset of an LFS to find an IP entirely contained in that subset, it can be said that the subset is *connected* (CN). However, the classical topology of a space is defined if a set of subsets of  $S$  called the open subsets, satisfies the following axioms (Munkres, 1999):

*Axiom C<sub>1</sub>:* The entire set and the empty subset  $\emptyset$  are open.

*Axiom C<sub>2</sub>:* The union of any number of open subsets is open.

*Axiom C<sub>3</sub>:* The intersection of a finite number of open subsets is open.

*Axiom C<sub>4</sub>:* The space has the separation property.

As for the axiom C<sub>4</sub>, in the case of LFSs, is only needed that for any pair of elements of the space there is an open subset which contains exactly one of the elements (axiom of separation  $T_\theta$ ). The LFS open set concept is materialized for a subset  $\theta$  when along with each element contains its SN.

When it contains all the elements of its frontier it is closed. Open subsets so defined satisfy the conditions of the axioms C<sub>1</sub> to C<sub>3</sub> and, therefore, are open in the classic sense. The SN of any element of an ALFS is open in the classic sense and is called the smallest open neighborhood (SON) of a given element of the space. All elements bounded by a given element are part of its SON. The SON of an element of the space satisfies the axiom of separation ( $T_\theta$ ).

## Abstract Cells Complexes

An important special case of LFS are abstract cells complexes (Listing, 1862). In this case, the space is characterized by a relationship of partial order among its elements and a function of dimension  $dim(a)$  which maps to an element of the space a non-negative integer so that if another element  $b \in SON(a)$ , then  $dim(a) \leq dim(b)$ . If  $dim(a) = k$ , then the element  $a$  is of dimension ( $k$ -dimensional).

An abstract cells complex (ACC)  $C = (E, B, dim)$  is a set  $E$  of abstract elements (cells) with a binary bounding relationship  $B \subset E \times E$  which is antisymmetric, irreflexive and transitive among its elements and a function  $dim E \rightarrow \mathbb{Z}^+$  provided  $dim(e') < dim(e'')$  for  $(e', e'') \in B$ . Between two elements  $a$  and  $k$  of an ACC establishes a bounding path if it is possible to find a sequence of elements between and so that each element bounds the following. The number of elements in the sequence minus one is the bounding path length. The dimension of a complex is given by the greatest dimension of all its cells. Given  $E' \subseteq E$  and  $B' = B \cap (E' \times E')$ ,  $S = (E', B')$  is a subcomplex of  $C$ . A subcomplex will be open or closed depending on the complex from which is subcomplex.

For example, given the complex  $C = (E, B)$  where  $E = \{e_1, e_2, e_3, e_4, e_5, l_1, l_2, l_3, l_4\}$ , the dimension function is such that  $dim(e_i) < dim(l_j)$  with  $B = \{(e_1, l_1), (e_2, l_1), (e_2, l_2), (e_3, l_2), (e_3, l_3), (e_4, l_3), (e_4, l_4), (e_5, l_4)\}$ , the subcomplex  $T = (E', B')$  with  $E' = \{e_3, l_3\}$  and  $B' = \{(e_3, l_3)\}$  is neither open nor closed in  $C$ . However, for the subcomplex  $E = (B')$ ,



$B''$ ) with  $E'' = \{e_3, e_4, l_3, l_4\}$ ,  $B'' = \{(e_3, l_3), (e_4, l_3), (e_4, l_4)\}$  and the same dimension function definition than before,  $T$  is open in  $S$ .

Given two subsets  $t$  and  $T$  of a space  $S$  such that  $t \subseteq T \subseteq S$ , the set containing with each cell  $a \in t$  also all cells of  $T$  bounding  $a$  is named the *closure* of  $t$  in  $T$  denoted by  $CL(t, T)$ . The set  $t - Fr(t, T)$  is called the *interior* of  $t$  in  $T$  and is denoted by  $Int(t, T)$ . The set  $t - T - Fr(t, T)$  is called the *exterior* of  $t$  in  $T$  and is denoted by  $Ext(t, T)$ .

The size and shape of the SON of a cell  $c$  depends on the complex  $C$  with base in which this is defined and is denoted by  $SON(c, C)$ . Two sub-complexes of a complex are mutually incidents, if any of the two contains at least one cell that is incident with any cell of the other.

### CARTESIAN COMPLEXES AND COMBINATORIAL COORDINATES

A particular case of ACC are Cartesian complexes. A complex  $C = (E, B)$  where  $E = \{e_0, e_1, e_2, \dots, e_{2m}\}$  with  $m \geq 1$ , the bounding relationship  $B$  is such that each element  $e_i$ , with even index  $i$ , bounds the elements  $e_{i+1}$ , and  $e_{i-1}$ , with odd index, is a 1-dimensional connected ACC. Here each 0-dimensional cell is closed, while each 1-dimensional cell is open. The cells indexes are called *combinatorial coordinates* in the one-dimensional space.



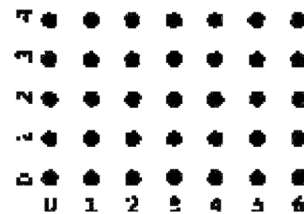
**Figure 3.** Graphical representations of a one-dimensional connected ACC. The 0-dimensional cells are represented with black spots while the 1-dimensional with red dots

**Source:** own work.

Figure 3 shows a possible graphical representations of one-dimensional ACC of combinatorial coordinates. In the figure each complex's cell is represented as a point, only that conveniently appears the  $i$ -dimensional cell with black color and the  $i-1$ -dimensional with red.

A Cartesian ACC is obtained by performing the Cartesian product of two or more of these one-dimensional complexes. The cells set of a  $n$ -dimensional Cartesian ACC  $C^n$  is the Cartesian product of  $n$  one-dimensional connected ACC sets. The one-dimensional complexes are the coordinate axes of  $C^n$  which become an  $n$ -dimensional space. A cell of  $C^n$  is an  $n$ -tuple  $c = (a_1, a_2, a_3, \dots, a_n)$  of  $a_i$  cells belonging each one to a particular one-dimensional complex and becoming a component cell of  $c$ . In this case, a cell  $c_1 = (a_1, a_2, a_3, \dots, a_n)$  bounds another cell  $c_2 = (b_1, b_2, b_3, \dots, b_n)$  if for each pair of component cells  $a_i$  and  $b_i$   $a_i = b_i$  or  $a_i$  bounds  $b_i$ . The dimension of a cell is the sum of the dimensions of its component cells.

For the one-dimensional ACCs  $A_1 = \{e_0, e_1, e_2, e_3, e_4, e_5, e_6\}$  and  $A_2 = \{e_0, e_1, e_2, e_3, e_4\}$ , figure 4 shows a possible two-dimensional Cartesian ACC graphical representations. In the figure each complex's cell is represented as a point, but the cells have been differentiated by color.



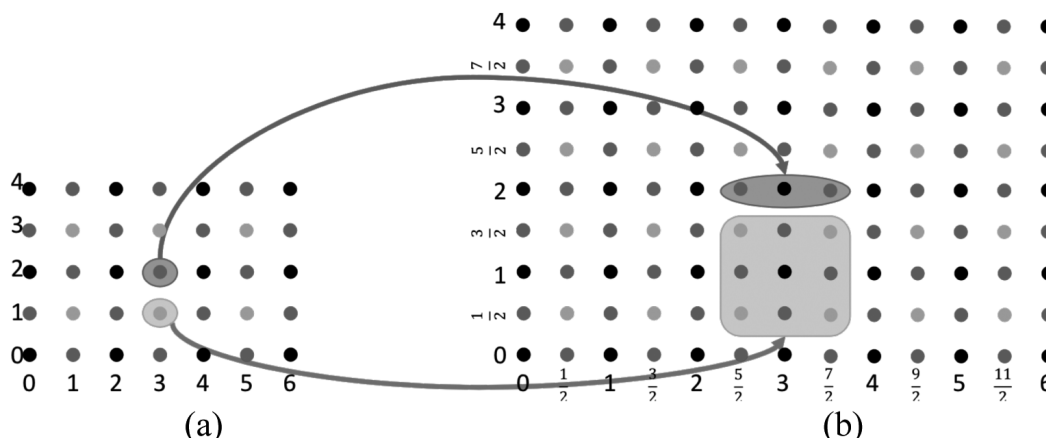
**Figure 4.** Graphical representations of a two-dimensional Cartesian ACC. The 0-dimensional cells are represented by black dots, the  $i$ -dimensional with red dots while the  $i-1$ -dimensional with green dots

**Source:** own work.

Kovalevsky defined the combinatorial balls and spheres in order to avoid "weird" complexes (i.e. pathological cases). For example, for the 2-dimensional Cartesian complex represented in figure 4, the subcomplex  $\{(e_i, e_j), (e_k, e_l)\}, (e_i, e_j) \neq (e_k, e_l), 0 \leq i \leq 6, 0 \leq j \leq 4, 0 \leq k \leq 6, 0 \leq l \leq 4$  is a 0-dimensional sphere and the subcomplex  $\{(e_{2i+1}, e_{2j+1})\}, 0 \leq i \leq 3, 0 \leq j \leq 1$  is a 2-dimensional open ball.

The concept of ACC enables the definition of strange ACCs, but topological concepts such as of ball and sphere can constraint the set of valid complexes. These concepts are also necessary for increasing or reducing the granularity of Cartesian complex. To increase the granularity, the elementary subdivision is used, and to reduce it, the blocks definition. The elementary subdivision (Stilwell,

1995) of a 1-dimensional cell  $C^1$ , replaces it with two 1-dimensional cells  $c_1^1, c_2^1$  and a 0-dimensional cell  $C^0$ , so that the latter is a common face of the other two. In the case of 2-dimensional Cartesian complex shown in the figure 4 elementary cell subdivision must be conducted in combinatorial way on each of its two component cells, taking into account that, in general, the  $-$ -dimensional cells are not subdivided.



**Figure 5.** Cells elementary subdivision in a  $-$ -dimensional Cartesian ACC. (a) initial Cartesian complex, (b) corresponding elementary subdivision. Red background represents the subdivision of a  $-$ -dimensional cell and green a  $-$ -dimensional

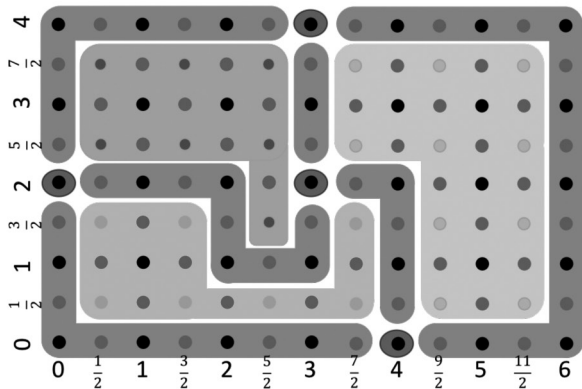
**Source:** own work.

For example, in a 2-dimensional Cartesian complex, the elementary subdivision of a 2-dimensional cell  $(e_i, e_j)$  origins three Combinatorial ordered for each component cell  $(e_{i-\frac{1}{2}}, e_i, e_{i+\frac{1}{2}}$  and  $e_{j-\frac{1}{2}}, e_j, e_{j+\frac{1}{2}}$ , here the average indexes are closed, while integers are open). This produces nine 2-dimensional coordinates, four of them correspond to  $-$ -dimensional cells, four to 1-dimensional and one is 0-dimensional as shown in figure 5. Two Cartesian complexes  $C_1$  and  $C_2$  are combinatorially homeomorphic if there are elementary subdivisions of  $C_1$  and  $C_2$  so obtained complexes are isomorphic.

Often in topological investigations and AC complexes applications to image analysis, the complexes contain thousands of cells, so it is

recommended to subdivide a complex in sub-complexes that are considered uniform with respect to some criterion in particular. The result of dividing a cell complex in blocks where each one consists of a homogeneous group of cells based on a specific criterion is called blocks complex (Rinow, 1975), (Kovalevsky, 1989). Consider a partition  $R$  of an  $n$ -dimensional complex  $A$  in  $k$ -dimensional subcomplexes  $S_i^k (k= 0, 1, \dots, n, 1_0, i, \dots, m)$ , the subsets with  $k = 0$  are some representative 0-dimensional cells of  $A$ , while each of the subsets with  $k > 0$  is combinatorially homeomorphic to a  $-$ -dimensional ball. It is possible to define a complex  $B$  whose cells correspond to the sub-complexes  $S_i^k$  called the block complexes of  $A$  and their cells are called block

cell. The subcomplexes  $S_i^k$  corresponding to the block cells are called blocks. Therefore, block cells are elements of the blocks complex, while the blocks are subcomplexes of the original cell complex. Each block cell dimension corresponds to the dimension of the respective subcomplex and the  $i$ th block with dimension  $m$  bounds  $j$ th block of dimension  $m, m > k$ , if there is in  $A$  two cell  $c_1 \in S_i^k$  and  $c_2 \in S_j^m$  such that  $c_1$  bounds  $c_2$ . The triplet  $B(A) = (EB, BR, Dim)$  is called blocks complex of  $A$  if there is a partition of  $A$  in subcomplexes  $S_i^k$  every one homeomorphic to a  $k$ -dimensional open ball.  $EB$  is the set of block cells, each cell  $b_i \in EB$  corresponds to a subcomplex  $S_i^k$  called the  $k$ -dimensional block or  $k$ -block of  $A$ . The ordered pair  $(b_i, b_j)$  block cells is in the bounding relationship  $BR$  if there is in  $A$  two cells  $c_1 \in S_i^k$  and  $c_2 \in S_j^m$  such that  $c_1$  bounds  $c_2$ . Dimension function  $Dim$  assigns to each block cell  $b_i$  of  $B(A)$  the dimension of the corresponding block  $S_i^k$ .



**Figure 6.** Example of a blocks complex on a 2-dimensional Cartesian complex

**Source:** own work.

Figure 6 shows the elementary subdivision of figure 5 with a partition into 13 blocks. In figure are highlighted conveniently, with a background that surrounds the original cells, the sub-complexes corresponding to block cells of the blocks complex that would be obtained. The sub-complexes correspond to 0,1 and 2-dimensional open balls. From 35 0-cells, 58 1-cells and 24 2-cells of the

original cells complex, there are four 0-block cell, six 1-block cell and three 2-block cell in the retrieved blocks complex.

## DISCUSSION

It has been demonstrated that Kovalevsky's (2006) alternative space representation does not arise topological paradoxes. Hence, it is suggested that these alternative space concepts could be a strong foundation for image segmentation in computer vision. Moreover, the usage of such ALFS spaces could be explored for remote sensing image analysis. Furthermore, it is relevant to investigate the potential of ALFS spaces for conducting a multispectral image segmentation that includes topological and geometric relationships besides spectral attributes.

It was discussed that conventional methods for remote sensing image segmentation are based on digital structures that violate well-established topological axioms and geometric algorithms that assume a continuous spatial computing model. Therefore, it is necessary to conduct a research to know how combinatorial properties of ALFS could allow the involvement of topological properties so that accuracy and efficiency of multispectral image segmentation algorithms can be improved.

In particular, it is necessary to evaluate an alternative multispectral image representation using Cartesian complexes in order to find an efficient solution to the segmentation process that takes into account topological and geometric properties. This implies to devise a conceptual model for multispectral image representation based on Cartesian complexes of abstract cells which takes into account topological and geometric properties. This can then build and evaluate a computational framework that enables the implementation of Cartesian complexes to adequately represent topological and geometric image-objects properties used in the segmentation of multispectral images.

The main hypothesis is that a spatial computational framework, based on the axiomatic locally finite spaces improves the accuracy of space

algorithms for multispectral image segmentation, since using only combinatorial coordinates established by Cartesian complexes preserves topological and geometric image-objects properties.

The production of a computational framework that makes possible the representation of a digital image in a way that explicitly takes into account on topological data and uses it for digital image segmentation, would constitute a significant technological development. It would strengthen the ability of the Engineering Faculty at Universidad Distrital to produce useful solutions to technical problems and to improve geospatial knowledge.

## CONCLUSIONS

Previous work attempting to produce topology preserving image segmentation in remote sensing used digital image representations that suffer from topological paradoxes. A more rigorous proposal for addressing such problems in computer vision image segmentation was suggested by Kovalevsky. It was shown that ALFS meet the classical axiomatic topological postulates and hence are able to unambiguously represent adjacency, connectedness and boundary relationships which are critical for appropriate multispectral image analysis, in particular image segmentation. It is therefore relevant and promising to conduct further in-depth research on the usage of Cartesian complexes for obtaining a topologically correct image representation in order to produce more accurate and effective image segmentation algorithms.

## FINANCING

This article has been done as part of the project's research Doctoral in engineering entitled "Development of an Alternative Method for Multispectral Image Segmentation Based on Cartesian Complexes and Its Associated Oriented Matroids", which was endorsed by the doctoral program in engineering of the Universidad Distrital and funded

by the University through Commission of studies granted between the period 2014I - 2016III.

## REFERENCES

- Arbeláez, P., Maire, M., Fowlkes, C. & Malik, J. (2009). From Contours to Regions: An Empirical Evaluation. *Proc. IEEE Conference Computer Vision and Pattern Recognition*.
- Arbeláez, P., Maire, M., Fowlkes, C. & Malik, J. (2011). Contour Detection and Hierarchical Image Segmentation. *IEEE Transactions on Pattern Analysis and Machine Intelligence (TPAMI)*, 33(5), 898-916.
- Baatz, M. & Schape, A. (2000). Multiresolution segmentation: An optimization approach for high quality multi-scale image segmentation. In J. Strobl, T. Blaschke & G. Griesebner (Edits.) *Angewandte Geographische Informations-Verarbeitung, XII*, 12-23.
- Benz, U. et al. Multi-resolution, object-oriented fuzzy analysis of remote sensing data for GIS-ready information. *ISPRS Journal of Photogrammetry and Remote Sensing*, 58(3-4), 239-258.
- Blaschke, T. (2010). Object based image analysis for remote sensing. *International Society for Photogrammetry and Remote Sensing, Inc. (ISPRS)*, 65, 2-16.
- Brice, R. & Fennema, C. L. (1970). Scene analysis using regions. *Artificial Intelligence*, 1, 205-226.
- Brun, L., Mokhtari, M. & Domenger, J. P. (2003). Incremental modifications on segmented image defined by discrete maps. *Journal of Visual Communication and Image Representation*, 14(3), 251-290.
- Cantor, G. (1883). "Über unendliche, lineare Punktmanigfaltigkeiten V" [On infinite, linear point-manifolds (sets)]. *Mathematische Annalen*, 21, 545-591.
- Cheevasuvut, F., Maitre, H. & Vidal-Madjar, D. (1986). A robust method for picture segmentation based on a split and merge procedure. *Graphical Models and Image Processing - CVGIP*, 34, 268-281.
- Chen, C., Freedman, D. & Lampert, C. (2011). Enforcing topological constraints in random field image segmentation. *IEEE Conference on Computer Vision and Pattern Recognition (CVPR)*, 2089-2096.



- Cracknell, A. P. (1998). Synergy in Remote Sensing – What's in a Pixel? *International Journal of Remote Sensing*, 19, 2025-2047.
- de Berg, M., Cheong, O., Kreveld, M. & Overmars, M. (2008). *Computational Geometry: Algorithms and Applications* (3rd ed.). Springer-Verlag Berlin Heidelberg.
- de Jong, S. M. & Van der Meer, F. D. (2004). *Remote Sensing Image Analysis Including the Spatial Domain*. Dordrecht, The Netherlands: Springer.
- de Loera, J., Rambau, J. & Santos, F. (2010). *Triangulations: Structures for Algorithms and Applications*. Verlag Berlin Heidelberg: Springer.
- Felzenszwalb, P. F. & Huttenlocher, D. P. (2004). Efficient graph-based image segmentation. *International Journal of Computer Vision*, 59(2), 167-181.
- Grady, L. (2012). Targeted Image Segmentation Using Graph Methods. In *Processing and Analysis with Graphs: Theory and Practice*, 111-140. CRC Press. Taylor & Francis Group.
- Guigues, L., le Men, H. & Cocquerez, J. P. (May de 2001). Graphs, cocoons and image segmentation. *Third Workshop on Graph Based Representations in Pattern Recognition (Gbr'2001), IAPR-TC15, CUEN*. 22-31. Ischia, Italy.
- Horowitz, S. L. & Pavlidis, T. (1976). Picture segmentation by a tree traversal algorithm. *J. Association for Computing Machinery*, 23(2), 368-388.
- Ishikawa, H. (2012). Graph Cuts—Combinatorial Optimization in Vision. In *Image Processing and Analysis with Graphs: Theory and Practice*, 25-64. CRC Press. Taylor & Francis Group.
- Johansen, K., Coops, N. C., Gergel, S. E. & Stange, J. (2007). Application of high spatial resolution satellite imagery for riparian and forest ecosystem classification. *Remote Sensing of Environment*, 110(1), 29-44.
- Knuth, D. (1992). *Axioms and hulls*. Berlin: Springer-Verlag.
- Kong, C., Xu, K. & Wu, C. (2006). Classification and extraction of urban land-use information from high-resolution image based on object multi-features. *Journal of China University of Geosciences*, 17(2), 151-157.
- Kong, T. Y. & Rosenfeld. (1991). Digital Topology, a Comparison of the graph based and Topological Approaches. In G. M. Reed, A. W. Ronscoe, & R. F. Wachter, *Topology and Category Theory in Computer Science*, 273-289. Oxford, U.K.: Oxford University press.
- Kovalevsky, V. A. (1984). Discrete topology and contour definition. *Pattern Recognit, Lett.* 2(5), 281-288.
- Kovalevsky, V. A. (1989). Finite Topology as Applied to Image Analysis. *Computer Vision, Graphics, and Image Processing*, 45(2), 141-161.
- Kovalevsky, V. A. (2001). Algorithms and Data Structures for Computer Topology Digital and Image Geometry. *Lecture Notes in Computer Science*, 2243, 38-58.
- Kovalevsky, V. A. (2005). Algorithms in Digital Geometry Based on Cellular Topology Combinatorial Image Analysis. *Lecture Notes in Computer Science*, 3322, 366-393.
- Kovalevsky, V. A. (2006). Axiomatic Digital Topology. *J Math Imaging*, 26(41-58).
- Kovalevsky, V. A. (2008). *Geometry of Locally Finite Spaces*. Berlin, Germany: Editing House Dr Baerbel Kovalevski.
- Letscher, D. & Fritts, J. (2007). Image Segmentation Using Topological Persistence. *Computer Analysis of Images and Patterns. Lecture Notes in Computer Science*, 4673, 587-595.
- Li, C. & Sun, Y. (2010). Active Image: A Shape And Topology Preserving Segmentation Method Using B-Spline Free Form Deformations. *Proceedings of 2010 IEEE 17th International Conference on Image Processing*, 2221-2224.
- Listing, J. (1862). Der census räumlicher complexe. *Abhandlungen der Königlichen Gesellschaft der Wissenschaften zu Göttingen*, 10, 97-182.
- Lizarazo, I. (2014). Accuracy assessment of object-based image classification: another STEP. *International Journal of Remote Sensing*, 35(16), 1-22.
- Lizarazo, I. & Elsner, P. (2009). Fuzzy segmentation for object-based image classification. *International Journal of Remote Sensing*, 30(6), 1643-1649.



- Munkres, J. (1999). *Topology* (2nd ed.). Prentice Hall.
- Neubert, M., Herold, H., Meinel, G. & Blaschke, T. (2008). Assessing image segmentation quality concepts, methods and application. Object-Based Image Analysis. *Lecture Notes in Geoinformation and Cartography*, 769-784. Springer Berlin Heidelberg.
- Oxley, J. (2003). *What is a matroid?* Recuperado el 12 de abril de 2011, de Cubo 5: [www.math.lsu.edu/~oxley/survey4.pdf](http://www.math.lsu.edu/~oxley/survey4.pdf)
- Pavlidis, T. (1977). *Structural Pattern Recognition*. New York: Springer-Verlag.
- Pfeifle, J. & Rambau, M. (2002). Computing Triangulations Using Oriented Matroids. *ZIB-Report 02-02*. Berlin: Konrad-Zuse-Zentrum für Informationstechnik.
- Richter-Gebert, J. & Ziegler, M. (2004). Oriented Matroids. En J. E. Goodman, & J. O'Rourke (Edits.), *Handbook of Discrete and Computational Geometry*, (2da ed., 29-151). Boca Raton: Chapman & Hall/CRC Press.
- Rinow, W. (1975). *Textbook of topology*. Berlin: VEB Deutscher Verlag der Wissenschaften.
- Rosenfeld, A. (1970). Connectivity in digital pictures. *J. ACM*, 17, 146-160.
- Saeedi, N. B. (2012). *On Fully Characterizing Terrain Visibility Graphs. A thesis submitted in partial fulfillment of the requirements for the degree of Master of Science*. The University of British Columbia.
- Schneider, M. (1977). Spatial Data Types for Database Systems: Finite Resolution Geometries for Geographic Information Systems. *Lecture Notes in Computer Science*, 1288.
- Stell, J. & Webster, J. (July de 2007). Oriented Matroids as a Foundation for Space in GIS. *Computers. Environment and Urban Systems*, 31(4), 379-392.
- Stilwell, J. (1995). *Classical topology and combinatorial group theory*. Springer.
- Tso, B. & Mather, P. (2009). *Classification Methods for Remotely Sensed Data*. Boca Raton, FL: CRC Press, Taylor & Francis Group.
- Urquhart, R. (1982). Graph theoretical clustering based on limited neighborhood sets. *Pattern Recognition*, 15(3), 173-187.
- Whitney, H. (1935). On the abstract properties of linear dependence. *American Journal of Mathematics*, 57, 509-533.
- Worboys, M. & Duckham, M. (2004). *GIS: A Computing Perspective* (2nd ed., 90-113). CRC Press.
- Yu, Q., Gong, P., Chinton, N., Biging, G., Kelly, M., & Schirokauer, D. (2006). Object based detailed vegetation classification with airborne high spatial resolution remote sensing imagery. *Photogrammetric Engineering & Remote Sensing*, 72(7), 799-811.
- Zahn, C. T. (1971). Graph-theoretic methods for detecting and describing gestalt clusters. *IEEE Transactions on Computing*, 20, 68-86.

## Software engineering as a vehicle for water resources environmental planning

### La ingeniería de software como vehículo para la planificación ambiental hídrica

Juan Pablo Rodríguez Miranda\*, Sandro Javier Bolaños Castro

\*\* , Cesar Augusto García Ubaque\*\*\*

**Fecha de recepción:** June 10th, 2014

**Fecha de aceptación:** November 4th, 2014

**Citation / Para citar este artículo:** Rodríguez Miranda, J. P., Bolaños Castro, S. J., & García Ubaque, C. A. (2014). Software engineering as a vehicle for water resources environmental planning. *Revista Tecnura*, 18 (Edición especial doctorado), 150–159. doi: 10.14483/udistrital.jour.tecnura.2014.DSE1.a13

#### ABSTRACT

Software engineering is an important discipline of knowledge that allows abstracting an environmental system, modeling a watershed and providing conceptual and interaction elements of players in the configuration of modeling approaches for decision-making on water resources environmental planning; therefore, the purpose of this article is to have an *environment envelope* through a set of environmental aspects that can be represented by a meta-model that leads to a *cognitive construct* of the problem and defines the methodological model for proper environmental planning of watersheds, in decision-making at strategic and operational levels.

**Keywords:** Environmental planning, municipal wastewater treatment plants, life cycle analysis, Software engineering.

sistema ambiental, modelar una cuenca hídrica y proporcionar elementos conceptuales y de interacción de actores en la configuración de enfoques de modelado para la toma de decisiones en la planificación ambiental hídrica. Por ello, la finalidad de este artículo es tener un *envolvente de entorno* a través de un conjunto de aspectos ambientales que se pueda representar mediante un metamodelo que conlleva a un *constructo cognitivo* del problema, que permita definir el modelo metodológico para una adecuada planificación ambiental de cuencas hídricas, en la toma de decisiones en niveles estratégicos y operativos.

**Palabras clave:** análisis del ciclo de vida, Ingeniería de Software, planificación ambiental, plantas de tratamiento de aguas residuales municipales.

#### RESUMEN

La Ingeniería de Software es una disciplina importante del conocimiento que permite abstraer un

\* Sanitary and Environmental Engineer. Master's Degree in Environmental Engineering. PhD Candidate in Environmental Engineering at Universidad Distrital Francisco José de Caldas. Associate Professor, Faculty of the Environment and Natural Resources Bogotá, D.C., Colombia. Email: [jprodriguez@udistrital.edu.co](mailto:jprodriguez@udistrital.edu.co)

\*\* Systems Engineer. Master's Degree in Teleinformatics. IT PhD. Associate Professor, Faculty of Engineering, Universidad Distrital Francisco José de Caldas. Bogotá, D.C., Colombia. Email: [sbolanos@udistrital.edu.co](mailto:sbolanos@udistrital.edu.co)

\*\*\* Civil Engineer. Master's Degree in Civil Engineering. PhD Civil Engineering. Associate Professor, Faculty of Technology, Universidad Distrital Francisco José de Caldas. Bogotá, D.C., Colombia. Email: [cagarciau@udistrital.edu.co](mailto:cagarciau@udistrital.edu.co)

## INTRODUCTION

Software engineering (IS acronym in Spanish) is a knowledge intensive discipline that has been used in the control of environmental systems and additionally has developed an interaction between the players and the configuration of the software (Dittrich, 2014; Hanssen, 2012; Bjarnason, 2012; Bjørnson, 2008; Sommerville, 2005), as well as in the spectrum of the generic modeling approaches that are capable of analyzing specific concepts through Machine Languages (LM acronym in Spanish), for the control of the possible solution (Bolaños S., 2014; David, 2013; Beecham, 2008).

In the abstraction of the environmental system, it is possible to consider the parametric development and evaluate the intrinsic environmental models, pursuant to the needs of the emergent client and even a potential user (David, 2013; Argent R., 2004; Briand, 2000; Rizzoli A., 2008); that is, taking IS as the foundation, this is a vehicle to migrate the principles of a modular system, specially one of processes, complex patterns, UML diagrams (*Unified Modeling Language*) (Bolaños S., 2012; Robles, 2012; Willard, 2007; Pilskalns, 2007), in decision making elements on the Water Resources Environmental Planning (PAH acronym in Spanish) of a Watershed (CH acronym in Spanish) through a methodology of Life Cycle Analysis (ACV acronym in Spanish), specifically through the action and pressure of the discharge of decontaminated effluents from Municipal Wastewater Treatment Plants (PTARM acronym in Spanish) installed in the (CH) (Rodríguez, 2010).

This article presents an analysis through IS, utilizes a Software Process and Methodology Modeling Language (LMMPS acronym in Spanish) (Bolaños S., 2014) in order to categorize and model the use cases diagrams, the sequence of types and activities (Bolaños S., 2012), and to present the abstraction of the PAH in a CH through the variable of the PTARM evaluated with a ACV through an analysis of the dynamic environmental context of the physical domain categorized as CH (Castelletti, 2010; Reed, 1999; Rizzoli A., 1997).

## METHODOLOGY

Some of the practices used in the integration of models in natural system with the IS may be the design oriented to objects, formalized modeling language (Argent R., 2001). The RUP (*Rational Unified Process*) process, allows the timely construction of a software and uses UML (*Unified Modeling Language*) to specify, visualize, construct and document a software system, reducing the complexity, and the process design while creating an optimum development. The RUP process presents three (3) essential characteristics such as the use cases, centered on the architecture and additionally it is interactive and incremental; it also has four (4) phases: the initial phase, the preparation phase, the construction phase and the transition phase, which represent the emphasis of the activities within each iteration (Florez, 2009; Pressman, 2010; Kroll, 2006; Jacobson, 2000; Tabares, 2011; Pilone, 2005). Within the set of tools of the RUP, it is worth mentioning, the administration of the requirements (change during the life of the project and identify the requirements of a system in technical and economic terms), the interactive development of the software (facilitates the implementation of requirements and characteristics; from each iteration all the products articulate in a predictable and repeatable manner), the visual modeling of the software (visualizes, specifies, constructs and documents the structure and behavior of the architecture of the software system), the continuous testing (the quality of the system is evaluated with respect to functionality, reliability and performance), the architecture based on components (allows the reutilization or adapting of the existing components), and the change control (establishes repeatable processes to manage the changes to the software) (Florez, 2009; Abrahamson, 2002; Kasoju, 2013).

For the representation of the natural language (LN acronym in Spanish), an *environment envelope* was used which is represented through a set of activities (Pressman, 2010; Sommerville,

2005) that articulate in the flow of the ACV in the PTARM, through a meta-model based on processes and methodologies (Germain, 2005), constructing a synergic concept that analyzes and totalizes the ACV in the PTARM (Bolaños S., 2012; Niazi, 2010) within a theoretical conceptual strategy. Therefore, the grammar with structure of phrases for the abstraction of the phenomenon studied is as follows:

- The grammar with structure of phrases  $G=(V, T, S, P)$  consists of a vocabulary  $V$ , a subset  $T$  of  $V$  formed by the terminal elements and an initial symbol  $S$  of  $V - T$  and a set  $P$  of productions (Bolaños S., 2014; Rosen, 2004; Chomsky, 1957).

- The vocabulary ( $V$ ) is a finite set and not void, whose elements are called symbols, where a word on  $V$  is a finite chain of elements of  $V$  (Bolaños S., 2014; Rosen, 2004; Chomsky, 1957).

According to the above, the language generated by  $G$  can be defined in the abstraction of the environmental system to be analyzed, in the following manner:

- For a set consisting of aspects, we have:  $N=\{PTARM, CA, EA, CH\}$  where  $CA$  (acronym in Spanish) is the environmental load and  $EA$  (acronym in Spanish) is the environmental effect.

- Then if  $PTARM \in CH$ , considers every  $PTARM$  as an element of  $CH$  set; then  $f, ACV \rightarrow N$ , it means that the ACV functionally maps the  $N$  set.

- Meaning that, the ACV is considered a function of  $PTARM, CA, EA, CH$  where it is possible to confirm and validate if  $(ACV, CH): PAH(ACV, CH)$ .

On the other hand, the ACV in  $PTARM$  is used to compare alternatives or to estimate the potential effect that can be obtained in the change of the product, and how it could be improved to decrease the environmental consequence at a global or regional scale (Benveniste, 2011). In general, one of the strengths of the ACV is that it considers global and regional impacts, and it makes it possible to estimate impacts that influence health and society; while one of its weaknesses is that it is not capable of analyzing the temporary or spatial character of a particular effect (De Carvalho F., 2001).

The ACV essentially presents two types of methodologies; the first one is based on the conventional

process of energy analysis and the flows of materials according to the manufacturing process, and the second one is based on the *input - output* (Leontief, 1986), that involves environmental data of the process to be analyzed, where the latter is the one more widely used in the studies (Zhang Q.H. *et al.*, 2010). The evolution of the ACV has moved from the products and materials to the analysis of the productive systems such as the Wastewater Treatment Plants and their influence on the environment (Deusto Tech, 2012; Rodríguez, 2010). A way of presenting the process in natural language, in machine language, as domain of the solution is through software engineering (Bolaños S., 2014), and this, in turn, may be represented by programming language, hence in a language for the modeling of software processes and methodologies.

## RESULTS

In the technical report on wastewater treatment systems in Colombia – base line 2010 (Marín, 2012), it was established that out of 1119 municipalities in Colombia, 490 have a PTARM (43.80%), there is a total of 556 PTARM in Colombia, where the greatest numbers of PTARM are located in the Departments of Cundinamarca and Antioquia. The capacity installed of PTARM is 33.2 m<sup>3</sup>/s, and as a conclusion the report establishes: absence of monitoring and control of the processes; no water characterizations are made, control records of the inflows and outflows are not kept, and the flow designs are unknown; therefore, the operation of the systems is conducted in an empiric, autonomous and customary manner; the lack of knowledge of the systems operated does not allow the proper planning of the expansion and optimization of the treatment systems; lack of corrective and preventive maintenance of the wastewater treatment systems; absence of vector control programs and sludge management; control over the discharge of non-residential wastewaters and conduct the monitoring of the compliance with current regulations.

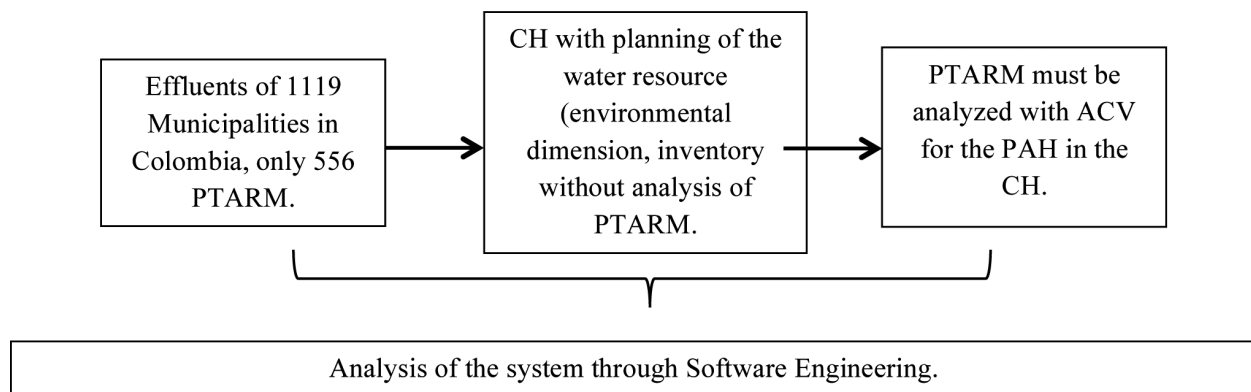
In addition to the above, the Asociación Colombiana de Ingeniería Sanitaria y Ambiental



(ACODAL, 2013), indicates that 31% of the cities in Colombia have PTARM (29% primary treatment and 1% tertiary treatment); where it has been observed the presence of improper selection of technologies, high investment and operation costs (although the investment allocated to the treatment of wastewaters does not reach 1% of the investment allocated to potable water), and very little protection of the water sources, which jeopardizes environmental sustainability, due to the contamination of the water resources, given the obsolete premise being used, which states that the water resources in Colombia are infinite. In general, the PTARM have always been seen as a black box (technologies that are highly efficient in the removal of contaminants, with low energy cost and economical operation (Rodríguez, 2010), as a solution at the end of the pipe, where contaminating elements and/or parameters enter, and then degrade or oxidize or transform and then are discharged as decontaminated flow into a receptor body of water, that is, under certain technical and economic limitations (Flores, 2014); however, every PTARM must contain three sustainability aspects (environmental protection, and social and economic development) (Garrido *et al.*, 2013).

On the other hand, the management strategies are focused on the regional planning of the water resource, the optimization of wastewater treatment plants already built and the development of new

treatment alternatives, and the reuse of wastewaters, as well as the review, update and regulatory development for the adjustment of policy instruments, but the environmental assessment of the PTARM in relation to the watersheds is not mentioned. However, by conserving the watershed through a more efficient assignment of the resource and in addition to evaluate the effects resulting from the development works and the contamination of the water resource in particular and the environment in general (García, 1998); but essentially, reference is made to what is politically viable and technically desirable, but with the explicit environmental assessment of the PTARM on the watershed. Given the preliminary issue, when taking the water from the offer present in the area of the study or watershed, and use it in the different anthropic activities (domestic, industrial, institutional, commercial, agricultural, etc.), the manipulated water is discharged or poured (liquid waste) onto the same body of water, in many cases without an adequate collection, treatment and disposal system, but in the form of contaminated or wastewater, limiting the availability of the water resource; it is then, when the processes and operations at the end of the pipe are used, denominated as municipal wastewater treatment plants or in amore integral concept, as wastewater treatment system (STAR acronym in Spanish) to decontaminate the wastewaters used in anthropic activities (Figure 1).



**Figure 1.** Cognitive scheme of the system and the interaction with software engineering

**Source:** Own work.



According to the above, a territorial environmental zoning is presented with an instrument such as environmental planning (PA acronym in Spanish), and this is a type of planning oriented to the operativeness of four general objectives of the environmental policy: the protection of components or especially vulnerable environments or environments estimated as valuable to society; the repair of damaged components or environments; the optimization of the uses of the land to minimize environmental loads, and the prevention and relief in relation to human wellbeing and health (Aronoff, 1989; Brilhante, 2003; Leitmann, 1999; Millar, 2004; Sheila, 2004).

The above takes into account aspects such as the study of the environmental impact, planning of protected areas, the environmental contributions to urban planning and territorial zoning and the sectorial planning for the protection or repair of certain components or environments (decontamination, recovery of rivers and bodies of water, and the management of biotopes, green area systems, etc.), that conventionally include the environmental dimension (DA acronym in Spanish) and the protection, management and zoning of the watersheds (PMOCH acronym in Spanish), and this, in turn, analyzes the inventory of the superficial and subterranean water resource (IRH acronym in Spanish), the influence of the population that exerts pressure over the CH through the socioeconomic activities of the Municipalities (M), the zones for the protection of the forests where the water springs are located (ZPB acronym in Spanish), the protection actions of the CH (APCH acronym in Spanish) and supply and demand of the water resource (ODRH acronym in Spanish), generate the following:

- If  $OAT f(PA)$  and  $PA f(PMOCH, DA)$ , then it can be consider that a representation of  $CHO IRH, M, ZPB, APCH, ODRH$ .
- A conceptualization of a PAH can be made considering  $N = \{PTARM, CA, EA, CH\}$
- Establishing that the ACV is considered a function of  $PTARM, CA, EA, CH$ , where it is possible

to confirm and validate if  $\forall(ACV, CH): PAH(ACV, CH)$ , it is possible to make an adequate planning of the CH and an interrelation of the environmental dynamics.

Therefore, it is possible to present scopes of analysis such as:

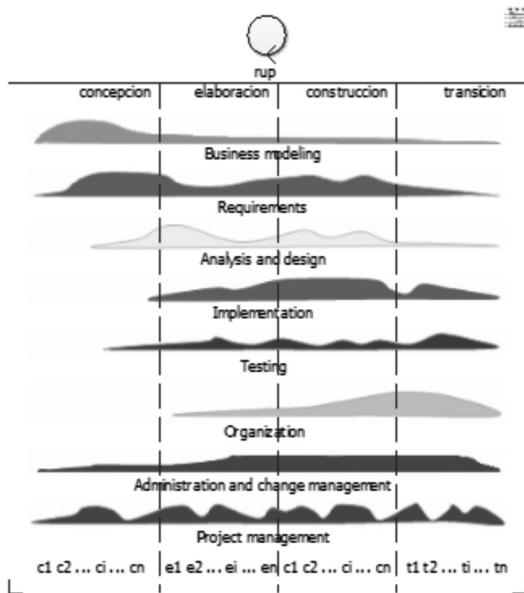
a) Identify and analyze factors that influence the behavior of the PTARM (CA and EA), and their interrelations with the environmental dynamics of the CH.

b) Develop an ACV methodology in the PTARM, taking into account a representation model (including the CA and the EA) and the influence of the components of the environmental dynamics and the sensibility analysis in the CH.

c) Apply the regional ACV methodology to the PTARM (constructed and projected) as a factor for the PAH of the CH, which will allow decision-making at strategic and operative levels (Salah, 2006; Castelliti, 2008; Dietrich, 2010).

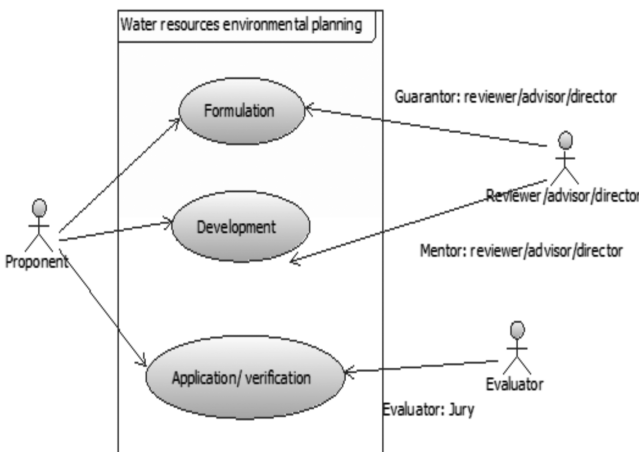
The meta-model proposed for the PAH, using the regional ACV methodology in PTARM, is based on players that define the development of the process (functions and actions), (Ellison, 1998; Mistic, 2004; Davis, 1994); therefore, the RUP process and the business modeling is used by means of the diagram of use cases to analyze the interaction of the players in the PAH, using the Coloso program in the following manner (Bolaños, 2010).

In a descriptive manner, Figures 2 and 3 explain the abstraction for the PAH from the point of view of the players that intervene in the analysis if  $(ACV, CH): PAH(ACV, CH)$ , it is possible to make an adequate planning of the CH and an interrelation of the environmental dynamics. However, the problem of the PAH can be represented through a requirement and sequence, in Figure 4, where it is expressed that the problem is the lack environmental strategies that do not contemplate the PAH and consequently, the hypothesis would be to verify and validate if with the PAH, including the ACV in PTARM, it is possible to conduct a sustainable environmental planning in CH.



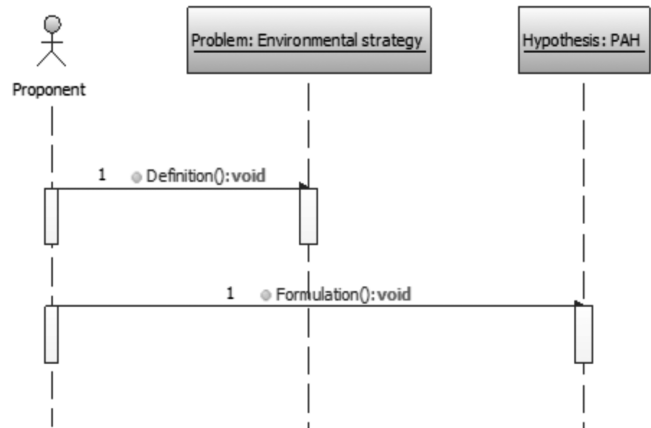
**Figure 2.** The RUP process applied to PAH

**Source:** Own work. Prepared using the Coloso program. (Bolaños S., 2010).



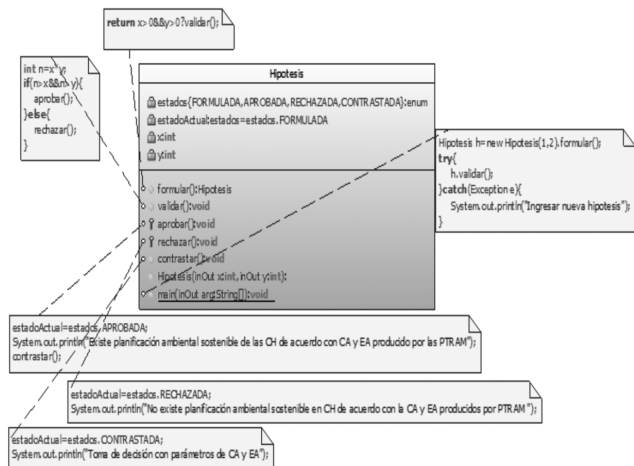
**Figure 3.** Business modeling using a diagram of use cases in PAH

**Source:** Own work. Prepared using the Coloso program (Bolaños S., 2010).



**Figure 4.** Requirement, using a sequence diagram in PAH

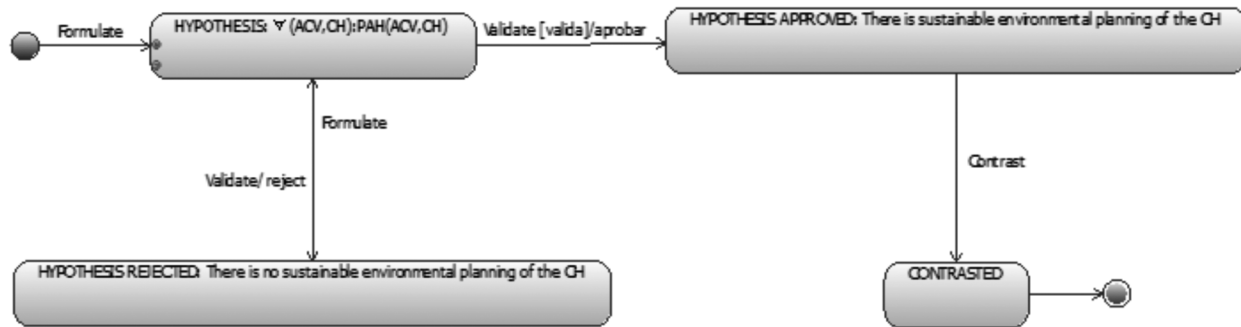
**Source:** Own work. Prepared using the Coloso program (Bolaños S., 2010).



**Figure 5.** Implementation, using a class diagram in PAH

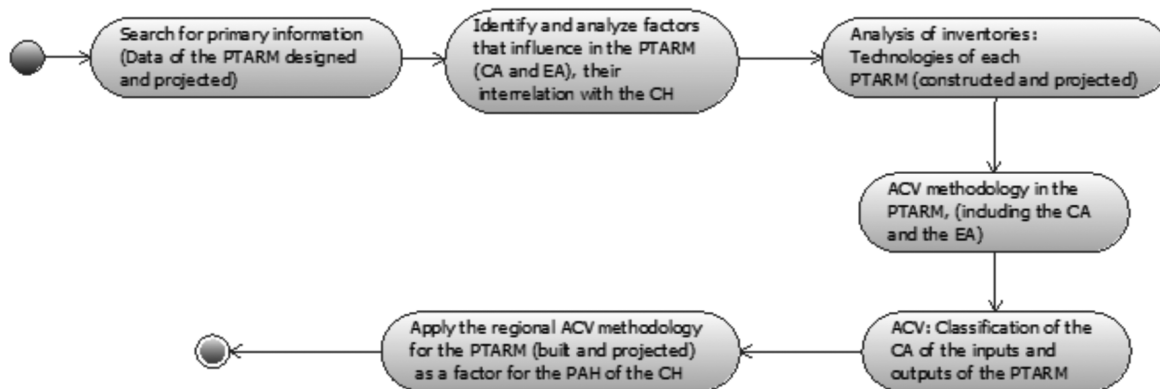
**Source:** Own work. Prepared using the Coloso program (Bolaños S., 2010).

A cognitive process in the class diagram is shown in figure 5, where a hypothesis is formulated; there, it is possible to validate if  $\forall(ACV, CH)$ : PAH (ACV, CH) and arrive to the adequate planning of the CH and an interrelation of the environmental dynamics, that is, if there is a sustainable environmental planning of the watersheds, according to the CA and the EA produced by the PTARM when using the ACV. Figure 6 expresses the alienation of the approval or rejection and the comparison of the formulated hypothesis.



**Figure 6.** Implementation, using a status diagram in the PHA

**Source:** Own work. Prepared using the Coloso program (Bolaños S., 2010).



**Figure 7.** Implementation, using an activity diagram in the PAH

**Source:** Own work. Prepared using the Coloso program (Bolaños S., 2010).

Figure 7 shows the research methodology applied for the verification of the PAH in CH, using an ACV in PTARM.

## CONCLUSIONS

The significant finding of this article is the exposition of a methodological scheme to interrelate the IS with the PAH, taken through a LMPS for decision-making in the PTARM investments, that is, the inclusion of CH and methodologies such as ACV in the configuration and personalization of the IS

through the RUP and UML language can be considered as an innovative benefit of the *software* product. The research process presented establishes the integration of the IS through methods with the PAH, the ACV and the PTARM for the analysis of the problems and the solutions in the CHs. It is also shown that in the methodology to confirm and validate if there is a PAH, when there is a consistent set of variables that belong to a set mapping that is interpreted as ACV, attains an strategy for decision-making in the investment on the PTARM in CH to achieve gradual and persistent decontamination of the superficial waters in a CH.

## ACKNOWLEDGEMENTS

The authors wish to thank the Curriculum Council of the PhD Program of the Universidad Distrital Francisco José de Caldas. Likewise, the authors express their gratitude to tenured professor Vidal Fernando Peñaranda Galvis of the Environmental and Natural Resources Faculty of the same University, for his review of this document.

## REFERENCES

- Abrahamsson, P. (2002). *Agile software development methods review and analysis*. VTT Publications.
- ACODAL. (2013). *Aguas residuales y ciudades*. Bogotá: Asociación Colombiana de Ingeniería Sanitaria y Ambiental.
- Argent, R. (2001). Land and water resources model integration: software engineering and beyond. *Advances in Environmental Research*, 351-359.
- Argent, R. (2004). An overview of model integration for environmental applications components, frameworks and semantics. *Environmental Modelling & Software*, 219-234.
- Aronoff, S. (1989). *Geographic Information Systems: A management perspective*. Ottawa, Canada: WDL Publications.
- Beecham, S. (2008). Motivation in Software Engineering: A systematic literature review. *Information and Software Technology*, 860-878.
- Benveniste, G. E. (2011). Análisis del ciclo de vida y reglas de categoría de producto en la construcción. El caso de las baldosa cerámicas. *Informes de construcción*, 71-81.
- Bjarnason, E. (2012). Are you biting off more than you can chew? A case study on causes and effects of overscoping in large-scale software engineering. *Information and Software Technology*, 1107-1124.
- Bjørnson, F. (2008). Knowledge management in software engineering: A systematic review studied concepts, findings and research methods used. *Information and Software Technology*, 1055-1068.
- Bolaños, S. (2010). AIA "Ambiente Ingenieril Artístico". Bogotá.
- Bolaños, S. (2012). LMPS como una propuesta alterna a BPMN para el modelado de procesos de software. *Tecnura*, 157-170.
- Bolaños, S. (2012). Process management software as a script and the as a pattern. *International Journal of Computer and Communication Engineering*, 147-150.
- Bolaños, S. (2012). Software process modeling language (SPML) as an alternative proposal to BPMN for modeling development processes. *Tecnura*, 158-171.
- Bolaños, S. (2014). Software Processes and Methodologies Modeling, Language –SPMML– Holistic Solution for Software Engineering. *IEEE Latin America Transactions*, 818-824.
- Briand, L. (2000). Exploring the relationships between design measures and software quality in object-oriented systems. *The Journal of Systems and Software*, 245-273.
- Brilhante, O. (2003). *Municipal Environmental Planning and Management Training*. The Netherlands: IHS.
- Castelletti, A. (2010). Visualization-based multi-objective improvement of environmental decision-making using linearization of response surfaces. *Environmental Modelling & Software*, 1552-1564.
- Castelliti, A. (2008). Integration, participation and optimal control in water resources planning and management. *Applied Mathematics and Computation*, 21-33.
- Chomsky, N. (1957). *Syntactic structures*. Berlin: Walter de Gruyter GmbH & Co.
- David, O. (2013). A software engineering perspective on environmental modeling framework design: The Object Modeling System. *Environmental Modelling & Software*, 201-213.
- Davis, A. (1994). Fifteen principles of software engineering. *Software IEEE*, 94-96.
- De Carvalho F, A. (2001). *Análisis del ciclo de vida de productos derivados del cemento - aportaciones al análisis de los inventarios del ciclo de vida del cemento*. Barcelona, España: Universidad Politécnica de Cataluña.
- Deusto Tech. (2012). *Metodología para el análisis del ciclo de vida de depuradoras de aguas residuales*. Deusto: Universidad de Deusto.



- Dietrich, J. (2010). Chapter 11. Workflow Oriented Participatory Decision Support for Integrated River Basin Planning.
- Dittrich, Y. (2014). Software engineering beyond the project sustaining software ecosystems. *Information and Software Technology*, 1436-1456.
- Ellison, M. (1998). Business process modelling using activity theory: An approach to data capture and analysis. *Australian Computer Journal*, 146-152.
- Flores X., E. A. (2014). Balancing effluent quality, economic cost and greenhouse gas emissions during the evaluation of (plant - wide) control/ operational strategies in WWTPs. *Science of the total environment*, 616-624.
- Flórez, H. (2009). Procesos de ingeniería de software. *Revista Vínculos*, 26-39.
- García, L. E. (1998). *El manejo integrado de los recursos hídricos en América Latina y el Caribe. No ENV - 125*. Washington D.C.: Banco Interamericano de Desarrollo, BID.
- Garrido M. et al. (2013). Including the environmental criteria when selecting a wastewater treatment plant. *Environmental modelling & software*, 85-95.
- Germain, E. (2005). Engineering-based processes and agile methodologies for software development: a comparative case study. *Journal of Systems and Software*, 17-27.
- Hanssen, G. (2012). A longitudinal case study of an emerging software ecosystem: Implications for practice and theory. *The Journal of Systems and Software*, 1455-1466.
- Jacobson, I. (2000). *El proceso unificado de desarrollo de software*. EE.UU.: Addison Wesley.
- Kasoju, A. (2013). Analyzing an automotive testing process with evidence-based software. *Information and Software Technology*, 1237-1259.
- Kroll, P. (2006). *Agility and Discipline Made Easy: Practices from Open UP and RUP*. Upper Saddle River, NJ: Addison Wesley Pub Co Inc.
- Leitmann, J. (1999). *Sustaining Cities: Environmental Planning and Management in Urban Design*. USA.
- Leontief, W. (1986). *Input - Output Economics. Second edition*. New York: Oxford University Press.
- Marín, D. (2012). *Informe técnico sobre sistemas de tratamiento de aguas residuales en Colombia - línea base 2010*. Bogotá D.C.: Superintendencia de Servicios Públicos Domiciliarios.
- Millar, D. (2004). *Integrating City Planning and Environmental Improvement: Practicable Strategies for Sustainable Urban Development*. London, UK.
- Misic, M. (2004). Systems analyst activities and skills in the new millennium. *Journal of Systems and Software*, 31-36.
- Niazi, M. (2010). Software process improvement barriers: A cross-cultural comparison. *Information and Software Technology*, 1204-1216.
- Pilone, D. (2005). *UML 2.0 in a Nutshell*. USA.
- Piskalns, O. (2007). Testing UML designs. *Information and Software Technology*, 892-912.
- Pressman, R. (2010). *Ingeniería del software. 7ª. Edición*. México: McGraw-Hill.
- Reed, M. (1999). A framework for modelling multiple resource management issues—an open modelling approach. *Environmental Modelling & Software*, 503-509.
- Rizzoli, A. (1997). Delivering environmental decision support systems: software tools and techniques. *Environmental Modelling & Software*, 237-249.
- Rizzoli, A. (2008). *Developments in Integrated Environmental Assessment. Chapter Seven. Integrated Modelling Frameworks for Environmental Assessment and Decision Support*. USA: Elsevier Science.
- Robles, K. (2012). Towards an ontology-based retrieval of UML Class Diagrams. *Information and Software Technology*, 72-86.
- Rodríguez J.P. (2012). Assessment of an aerobic treatment system for. *Int. J. Environmental Engineering*, 307-314.
- Rodríguez J.P. et al. (2013). *Diseño y evaluación de un sistema de tratamiento de aguas residuales (sedimentador Sedhelcon y reactor biológico aeróbico modificado Floclairf) en planta piloto*. Bogotá: Universidad Distrital.
- Rodríguez J.P., et al. (2010). Estudio de comparación del tratamiento de aguas residuales domésticas utilizando lentejas y buchón de agua en humedales



- artificiales. *Tecnología y ciencias del agua (Ingeniería hidráulica en México)*, 59-68.
- Rodríguez, J. (2010). Contaminación del agua. In *Contaminación ambiental en Colombia*, 255- 300). Bogotá: Fundación en causa por el desarrollo humano.
- Rosen, K. (2004). *Matemática discreta*. New York: McGraw-Hill.
- Salah, A. (2006). Use of goal programming and integer programming for water quality management—A case study of Gaza Strip. *European Journal of Operational Research*, 1991-1998.
- Sheila, S. (2004). *Earthly Politics: Local and Global in Environmental Governance (Politics, Science, and the Environment)*. USA.
- Sommerville, I. (2005). *Ingeniería de Software*. Madrid, España: Pearson Education S.A.
- Tabares, L. (2011). *Personalización de RUP para proyectos académicos de desarrollo de software*. Medellín, Colombia: EAFIT.
- Willard, B. (2007). UML for systems engineering. *Computer Standards & Interfaces*, 69-81.
- Zhang Q.H. *et al.* (2010). Application of life cycle assessment for an evaluation of wastewater treatment and reuse project - case study of Xi An, China. *Bio-resource technology*, 1421- 1425.

## Parallel programming languages on heterogeneous architectures using openmpc, ompss, openacc and openmp

### Lenguajes para programación paralela en arquitecturas heterogéneas utilizando openmpc, ompss, openacc y openmp

Esteban Hernández B.\*, Gerardo de Jesús Montoya Gaviria\*\*, Carlos Enrique Montenegro\*\*\*

**Fecha de recepción:** June 10th, 2014

**Fecha de aceptación:** November 4th, 2014

**Citation / Para citar este artículo:** Hernández, E., Gaviria, G. de J. M., & Montenegro, C. E. (2014). Parallel programming languages on heterogeneous architectures using OPENMPC, OMPSS, OPENACC and OPENMP. *Revista Tecnura*, 18 (Edición especial doctorado), 160–170. doi: 10.14483/udistrital.jour.tecnura.2014.DSE1.a14

#### ABSTRACT

On the field of parallel programming has emerged a new big player in the last 10 years. The GPU's have taken a relevant importance on scientific computing because they offer a high performance computing, low cost and simplicity of implementation. However, one of the most important challenges is the program languages used for this devices. The effort for recoding algorithms designed for CPUs is a critical problem. In this paper we review three of principal frameworks for programming CUDA devices compared with the new directives introduced on the OpenMP 4 standard resolving the Jacobi iterative method.

**Keywords:** CUDA, Jacobi method, OmpSS, OpenACC, OpenMP, OpenMP, Parallel Programming.

#### RESUMEN

En el campo de la programación paralela, ha arribado un nuevo gran jugador en los últimos 10 años. Las GPU han tomado una importancia relevante en la computación científica debido a que ofrecen alto rendimiento computacional, bajo costos y simplicidad de implementación; sin embargo, uno de los desafíos más grandes que poseen son los lenguajes utilizados para la programación de los dispositivos. El esfuerzo de reescribir algoritmos diseñados originalmente para CPU es uno de los mayores problemas. En este artículo se revisan tres frameworks de programación para la tecnología CUDA y se realiza una comparación con el reciente estándar OpenMP versión 4, resolviendo el método iterativo de Jacobi.

**Palabras clave:** Método de Jacobi, OmpSS, OpenACC, OpenMP, Programación paralela.

\* Network Engineering with Master degree on software engineering and Free Software construction, minor degree on applied mathematics and network software construction. Now running Doctorate studies on Engineering at Universidad Distrital and works as principal architect on RUNT. Now works in focus on Parallel Programming, high performance computing, computational numerical simulation and numerical weather forecast. E-mail: [ejhernandezb@udistrital.edu.co](mailto:ejhernandezb@udistrital.edu.co)

\*\* Engineer in meteorology from the University of Leningrad, with a doctorate in physical-mathematical sciences of State Moscow University, pioneer in the area of meteorology in Colombia, in charge of meteorology graduate at Universidad Nacional de Colombia, researcher and director of more than 12 graduate theses in meteorology dynamic area and numerical forecast, air quality, efficient use of climate models and weather. He is currently a full professor of the Faculty of Geosciences at Universidad Nacional de Colombia. E-mail: [gdmontoyag@unal.edu.co](mailto:gdmontoyag@unal.edu.co)

\*\*\* System Engineering, PhD and Master degree on Informatics, director of research group GIIRA with focus on Social Network Analyzing, eLearning and data visualization. He is currently associate professor of Engineering Faculty at Universidad Distrital. E-mail: [cemontenegro@udistrital.edu.co](mailto:cemontenegro@udistrital.edu.co)

## INTRODUCTION

Since 10 years ago, the massively parallel processors have used the GPUs as principal element on the new approach in parallel programming; it's evolved from a graphics-specific accelerator to a general-purpose computing device and at this time is considered to be in the era of GPUs. (Nickolls & Dally, 2010). However, the main obstacle for large adoption on the programmer community has been the lack of standards that allow programming on unified form different existing hardware solutions (Nickolls & Dally, 2010). The most important player on GPU solutions is Nvidia® with the CUDA® language programming and his own compiler (nvcc) (Hill & Marty, 2008), with thousands of installed solutions and reward on top500 supercomputer list, while the portability is the main problem. Some community project and some hardware alliance have proposed solutions for resolve this issue. OmpSS, OpenACC and OpenMPC have emerged as the most promising solutions (Vetter, 2012) using the OpenMP base model. In the last year, OpenMP board released the version 4 (OpenMP, 2013) application program interface with support for external devices (including GPUs and Vector Processors). In this paper we compare the four implementation of Jacobi's factorization, to show the advantages and disadvantages of each framework.

## METHODOLOGY

The frameworks used working as extensions of #pragmas of the C languages offering the simplest way to programming without development complicate and external elements. In the next section we describe the frameworks and give some implementations examples. In the last part, we show the pure CUDA kernels implementations.

### Ompss

Ompss (a programming model from Barcelona Supercomputer center based on OpenMP and StarSs)

is framework focusses on task decomposition paradigm for developing parallel applications on cluster environments with heterogeneous architectures. It provides a set of compiler directives that can be used to annotate a sequential code. Additional features have been added to support the use of accelerators like GPUs. OmpSS is based on StartsS a task based programming model. It is based on annotating a serial application with directives that are translated by the compiler. With it, the same program that runs sequentially in a node with a single GPU can run in parallel in multiple GPUs either local (single node) or remote (cluster of GPUs). Besides performing a task-based parallelization, the runtime system moves the data as needed between the different nodes and GPUs minimizing the impact of communication by using affinity scheduling, caching, and by overlapping communication with the computational task.

OmpSs is based on the OpenMP programming model with modifications to its execution and memory model. It also provides some extensions for synchronization, data motion and heterogeneity support.

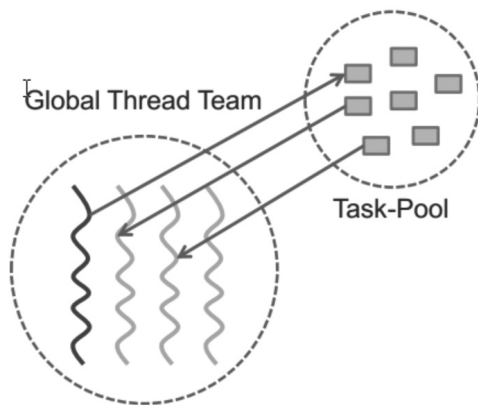
1) Execution model: OmpSs uses a thread-pool execution model instead of the traditional OpenMP fork-join model. The master thread starts the execution and all other threads cooperate executing the work it creates (whether it is from work sharing or task constructs). Therefore, there is no need for a parallel region. Nesting of constructs allows other threads to generate work as well (Figure 1).

2) Memory model: OmpSs assumes that multiple address spaces may exist. As such shared data may reside in memory locations that are not directly accessible from some of the computational resources. Therefore, all parallel code can only safely access private data and shared data which has been marked explicitly with our extended syntax. This assumption is true even for SMP machines as the implementation may reallocate shared data to improve memory accesses (e.g., NUMA).

### 3) Extensions:

**Function tasks:** OmpSs allows to annotate function declarations or definitions Cilk (Durán, Pérez, Ayguadé, Badia & Labarta, 2008), with a task directive. In this case, any call to the function creates a new task that will execute the function body. The data environment of the task is captured from the function arguments.

**Dependency synchronization:** OmpSs integrates the StarSs dependence support (Durán *et al.*, 2008). It allows annotating tasks with three clauses: input, output, in/out. They allow expressing, respectively, that a given task depends on some data produced before, which will produce some data, or both. The syntax in the clause allows specifying scalars, arrays, pointers and pointed data.



**Figure 1.** OmpSS execution model

**Source:** Barcelona supercomputing Center, p. 11. [http://www.training.prace-ri.eu/uploads/tx\\_pracetmo/OmpSsQuickOverviewXT.pdf](http://www.training.prace-ri.eu/uploads/tx_pracetmo/OmpSsQuickOverviewXT.pdf)

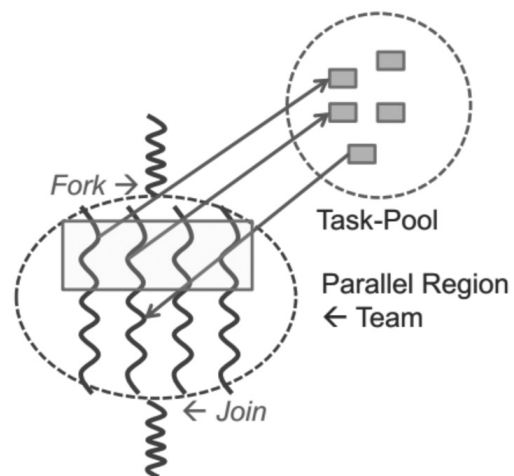
## OpenACC

OpenACC is an industry standard proposed for heterogeneous computing on SuperComputer Conference 2011. OpenACC follows the OpenMP approach, with annotation on Sequential code with compiler directives (pragmas), indicating those regions of code susceptible to be executed in the GPU.

The execution model targeted by OpenACC API-enabled implementations is host-directed execution

with an attached accelerator device, such as a GPU. Much of a user application executes on the host. Compute intensive regions are offloaded to the accelerator device under control of the host. The device executes parallel regions, which typically contain work-sharing loops, or kernels regions, which typically contain one or more loops which are executed as kernels on the accelerator. Even in accelerator-targeted regions, the host may orchestrate the execution by allocating memory on the accelerator device, initiating data transfer, sending the code to the accelerator, passing arguments to the compute region, queuing the device code, waiting for completion, transferring results back to the host, and de-allocating memory (Figure 2). In most cases, the host can queue a sequence of operations to be executed on the device, one after the other (Wolfe, 2013).

The actual problems with OpenACC are relationship with the only for-join model support and support for only commercial compilers can support his directives (PGI, Cray and CAPS) (Wolfe, 2013; Reyes, López, fumero & Sande, 2012). In the last year, only one open source implementations has support (accULL) (Reyes & López-Rodríguez, 2012).



**Figure 2.** OpenACC execution model

**Source:** Barcelona supercomputing Center p. 11. [http://www.training.prace-ri.eu/uploads/tx\\_pracetmo/OmpSsQuickOverviewXT.pdf](http://www.training.prace-ri.eu/uploads/tx_pracetmo/OmpSsQuickOverviewXT.pdf)

## OpenMPC

The OpenMPC (OpenMP extendent for CUDA) is a framework to hide the complexity of programming model and memory model to user (Lee & Eigenmann, 2010). OpenMPC consists of a standard OpenMP API plus a new set of directives and environment variables to control important CUDA-related parameters and optimizations.

OpenMPC addresses two important issues on GP-GPU programming: programmability and tunability. OpenMPC as a front-end programming model provides programmers with abstractions of the complex CUDA programming model and high-level controls over various optimizations and CUDA-related parameters. OpenMPC included fully automatic compilation and user-assisted tuning system supporting OpenMPC. In addition to a range of compiler transformations and optimizations, the system includes tuning capabilities for generating, pruning, and navigating the search space of compilation variants.

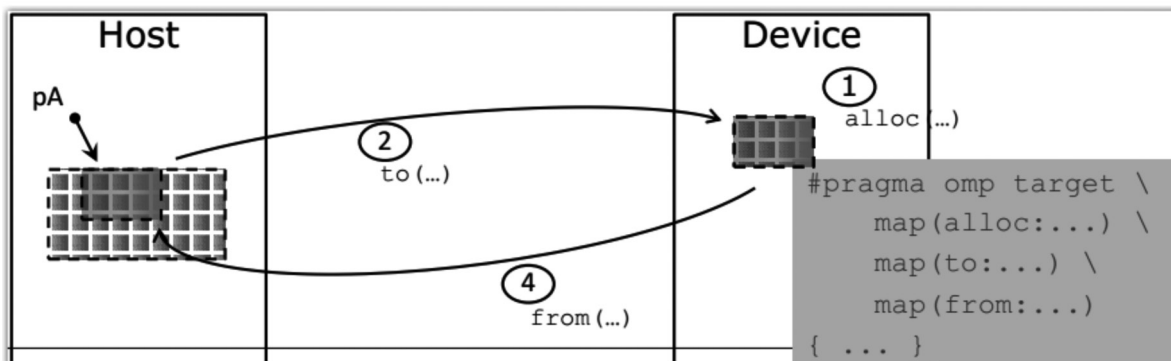
OpenMPC use the compiler cetus (Dave, Bae, Min & Lee, 2009) for automatic parallelization source to source. The Source code on C has 3 level of analyzing

- Privatization
- Reduction Variable Recognition
- Induction Variable substitution

OpenMPC adding a numbers of pragmas for annotate OpenMP parallel regions and select optimization regions. The pragmas added has the following form: `#pragma cuda <<function>>`.

## OpenMP release 4

OpenMP is the most used framework for programming parallel software with shared memory and support on most of the existing compilers. With the explosion of multicore and manycore system, OpenMP gains acceptance on parallel programming community and hardware vendors. From his creation to version 3 the focus of API was the CPUs environments, but with the introduction of GPUs and vector accelerators, the new 4 release includes support for external devices (OpenMP, 2013). Historically, OpenMP has support Simple Instruction Multiple Data (SIMD) model only focusses on fork-join model (Figure 3), but in this new release the task-base model (Duran *et al.*, 2008; Podobas, Brorsson & Faxén, 2010) has been introduced to gain performance with more parallelism on external devices. The most important directives introduced were `target`, `teams` and `distributed`. This directives permit that a group of threads was distributed on a special devices and the result was copied to host memory (Figure 3).



**Figure 3.** OpenMP 4 execution model

**Source:** Intel Parallel OpenMP. <http://www.theclassifiedsplus.com/video/video/axnA3kcLHK4/intel-parallel-openmp.html>



## JACOBI ITERATIVE METHOD

Iterative methods are suitable for large scale linear equations. There are three commonly used iterative methods: Jacobi's method, Gauss method and SOR iterative methods (Gravvanis, Filelis-Papadopoulos & Lipitakis, 2013; Huang, Teng, Wahid & Ko, 2009).

The last two iterative methods convergence speed is faster than Jacobi's iterative method but lack of parallelism. They have advantages to Jacobi method only when implemented in sequential fashion and executed on traditional CPUs. On the other hand, Jacobi's iterative method has inherent parallelism. It's suitable to be implemented on CUDA or vector accelerators to run concurrently on many cores. The basic idea of Jacobi method is convert the system into equivalent system then we solved Equation (1) and Equation (2):

$$x = B \begin{cases} a_{11}x_{11} + a_{12}x_2 + a_{13}x_3 = b_1 \\ a_{21}x_{22} + a_{22}x_2 + a_{23}x_3 = b_2 \\ a_{31}x_{33} + a_{32}x_2 + a_{33}x_3 = b_3 \end{cases} \quad (1)$$

$$\begin{aligned} x_1 &= -\frac{a_{12}}{a_{11}}x_2 - \frac{a_{13}}{a_{11}}x_3 + \frac{b_1}{a_{11}} \\ x_2 &= -\frac{a_{21}}{a_{22}}x_1 - \frac{a_{23}}{a_{22}}x_3 + \frac{b_2}{a_{22}} \\ x_3 &= -\frac{a_{31}}{a_{33}}x_1 - \frac{a_{32}}{a_{33}}x_2 + \frac{b_3}{a_{33}} \end{aligned}$$

On each iteration we solve :

$$x^k_i = \frac{1}{a_{i,i}} \left[ b_i - \sum_{j \neq i} a_{i,j} x^{k-1}_j \right] \quad (2)$$

Where the values from the (k-1) iteration are used to compute the values for the kth iteration. The pseudo code for Jacobi method (Dongarra et al., 2008):

```
Choose an initial guest to the solution x.
for k=1,2,...
```

```
  for i=1,2,...n
```

```
    x_i=0
```

```
    for j=1,2,...,i-1,i+1,...n
```

```
      x_i = x_i + ai,jxj(k-1)
```

```
    end
```

```
    x_i = (b_i + x_i)/ ai,i
```

```
  end
```

```
  x(k)=x
```

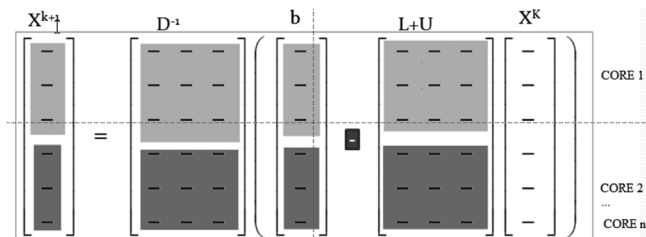
```
  check convergence; continue
```

```
if necessary
```

```
end
```

This iterative method can be implemented on a parallel form, using shared or distributed memory (Margaris, Souravlas & Roumeliotis, 2014) (Figure 4). For distributed memory, it needs some explicit synchronization and data out-process data copy. In share memory, it needs distribution and data merge in memory. It uses the following method:

$$x^{k+1} = D^{-1}(b - (L+U)x^k) \quad (3)$$



**Figure 4.** Parallel form of Jacobi method on shared memory (Alsemmeri, n.d.)

**Source:** Parallel Jacobi Algorithm <https://www.cs.wmich.edu/~elise/courses/cs626/s12/PARALLEL-JACOBI-ALGORITHM11.pptx>

## OPENMP IMPLEMENTATION

```
int n=LIMIT_N;
int m=LIMIT_M;
A[n][m]; // the D-1 matrix
```

```

Anew [n][m];
y_vector[n]; //b vector
//fill the matriz with initial conditions
...
#pragma omp parallel for shared (m, n, Anew,
A)
    for (int j = 1; j < n-1; j++)
    {
        for (int i = 1; i < m-1; i++)
        {
            Anew[j][i] = 0.25f * ( A[j][i+1] + A[j][i-1]
                + A[j-1][i] + A[j+1][i]);
            error = fmaxf( error, fabsf(Anew[j][i]-A[j]
[i]));
        }
    }
#pragma omp parallel for shared (m, n,
Anew, A)
    for (int j = 1; j < n-1; j++)
    {
        for (int i = 1; i < m-1; i++)
        {
            A[j][i] = Anew[j][i];
        }
    }
    if (iter % 100 == 0) printf(“%5d, %0.6f\n”,
iter, error);
    iter++;
}
...//print the result

```

In this section, the for-joint model appears on section annotate with *#pragma omp parallel for shared (m, n, Anew, A)* where every threads (normally equals to cores) on system running a copy of code with different data section shared all variables named on *shared()* section. When the size of *m* and *n* is minor or equals to number of cores, the performance is similar on GPUs and CPUs, but when the size if much higher that number of cores available, the performance of GPUs increases because the parallelism level is higher (Fowers, Brown, Cooke & Stitt, 2012; Zhang, Miao, & Wang, 2009).

## OPENACC IMPLEMENTATION

```

int n=LIMIT_N;
int m=LIMIT_M;
A[n][m]; // the D-1 matrix
Anew [n][m];
y_vector[n]; //b vector
//fill the matriz with initial conditions
...
#pragma omp parallel for shared (m, n, Anew,
A)
#pragma acc kernels
    for( int j = 1; j < n-1; j++)
    {
        for( int i = 1; i < m-1; i++)
        {
            Anew[j][i] = 0.25f * ( A[j][i+1] + A[j][i-1]
                + A[j-1][i] + A[j+1][i]);
            error = fmaxf( error, fabsf(Anew[j][i]-A[j]
[i]));
        }
    }
#pragma omp parallel for shared (m, n, Anew,
A)
#pragma acc kernels
    for( int j = 1; j < n-1; j++)
    {
        for( int i = 1; i < m-1; i++)
        {
            A[j][i] = Anew[j][i];
        }
    }
    if(iter % 100 == 0) printf(“%5d, %0.6f\n”,
iter, error);
    iter++;
}
...//print the result

```

In this implementation appears a new annotation *#pragma acc kernels*, where it indicates that the code will be executed. This simple annotation hides a complex implementation of CUDA kernel, the copy of data from host to devices and devices to GPU and definition of grid of threads and the

data manipulation (Amorim & Haase, 2009; Sanders & Kandrot, 2011; Zhang *et al.*, 2009).

## PURE CUDA IMPLEMENTATION (WANG, N.D.)

```

...
int dimB, dimT;
dimT = 256;
dimB = (dim / dimT) + 1;

float err = 1.0;

// set up the memory for GPU
float * LU_d;
float * B_d;
float * diag_d;
float *X_d, *X_old_d;
float * tmp;

    cudaMalloc( (void **) &B_d, sizeof(float) *
dim );
    cudaMalloc( (void **) &diag_d, sizeof(float)
* dim );
    cudaMalloc( (void **) &LU_d, sizeof(float) *
dim * dim);

    cudaMemcpy( LU_d, LU, sizeof(float) * dim *
dim, cudaMemcpyHostToDevice);
    cudaMemcpy( B_d, B, sizeof(float) * dim,
cudaMemcpyHostToDevice);
    cudaMemcpy( diag_d, diag, sizeof(float) *
dim, cudaMemcpyHostToDevice);

    cudaMalloc( (void **) &X_d, sizeof(float) *
dim);
    cudaMalloc( (void **) &X_old_d, sizeof(float)
* dim);
    cudaMalloc( (void **) &tmp, sizeof(float) *
dim);
...
//call to cuda kernels

// 2. Compute X by A x_old

```

```

    cudaMemcpy( X_old_d, x_old, sizeof(float)
* dim, cudaMemcpyHostToDevice);
    matMultVec<<<<dimB, dimT>>>(LU_d, X_
old_d, tmp, dim, dim); // use x_old to compute
LU X_old and store the result in tmp
    substract<<<<dimB, dimT>>>(B_d, tmp,
X_d, dim); // get the (B - LU X_old), which is
stored in X_d
    diaMultVec<<<<dimB, dimT>>>(diag_d,
X_d, dim); // get the new X

// 3. copy the new X back to the Host
Memory
    cudaMemcpy( X, X_d, sizeof(float) * dim,
cudaMemcpyDeviceToHost);

// 4. calculate the norm of X_new - X_old
substract<<<<dimB, dimT>>>(X_old_d, X_d,
tmp, dim);
VecAbs<<<<dimB, dimT>>>(tmp, dim);
VecMax<<<<dimB, dimT>>>(tmp, dim);
// copy the max value from Device to Host
cudaMemcpy(max, tmp, sizeof(float),
cudaMemcpyDeviceToHost);
// cuda kernel for vector multiplication
__global__ void matMultVec(float * mat_A,
float * vec,
float * rst,
int dim_row,
int dim_col)
{
    int rowIdx = threadIdx.x + blockIdx.x *
blockDim.x; // Get the row Index
    int ald;
    while(rowIdx < dim_row)
    {
        rst[rowIdx] = 0; // clean the value at first
        for (int i = 0; i < dim_col; i++)
        {
            ald = rowIdx * dim_col + i; // Get the
index for the element a_{rowIdx, i}
            rst[rowIdx] += (mat_A[ald] * vec[i] ); // do
the multiplication
        }
    }
}

```

```

    rowIdx += gridDim.x * blockDim.x;
}
__syncthreads();
}

// cuda kernel for vector subtraction
__global__ void substract(float *a_d,
    float *b_d,
    float *c_d,
    int dim)
{
    int tid = threadIdx.x + blockDim.x * blockIdx.x;
    while ( tid < dim )
    {
        c_d[tid] = a_d[tid] - b_d[tid];
        tid += gridDim.x * blockDim.x;
    }
}

__global__ void VecMax(float * vec, int dim)
{
    int tid = threadIdx.x + blockDim.x * blockIdx.x;
    while (dim > 1)
    {
        int mid = dim / 2; // get the half size
        if (tid < mid) // filter the active thread
        {
            if (vec[tid] < vec[tid+mid] ) // get the larger
one between vec[tid] and vec[tid+mid]
                vec[tid] = vec[tid+mid]; // and store the
larger one in vec[tid]
        }

        //deal with the odd case
        if (dim % 2 ) // if dim is odd...we need care
about the last element
        {
            if (tid == 0 ) // only use the vec[0] to com-
pare with vec[dim-1]
            {
                if (vec[tid] < vec[dim-1] )

```

```

        vec[tid] = vec[dim-1];
    }
}

__syncthreads(); // sync all threads
dim /= 2; // make the vector half size short.
}
}

```

The effort for writing three kernels, management the logic of grids dimensions, copy data from hosts to GPU and GPU to host, the aspect of synchronization thread on the groups of Threads on GPU and some aspects as ThreadID calculation required high computation on hardware devices and code programming.

## TEST TECHNIQUE

We take the three implementations of Jacobi method (Pure OpenMP, OpenACC, OpenMPC) and running it on SUT (System Under Test) of Table 1, and make multiples running with square matrices of incremental sizes (Table 2), take processing time for analyzing the performance (Kim, n.d.; Sun & Gustafson, 1991) against the code number lines needed on the algorithm.

**Table 1.** Characteristics of System under Test

<b>System</b>	Supermicro SYS-1027GR-TRF
<b>CPU</b>	Intel® Xeon® 10-core E5-2680 V2 CPUs @ 2.80 GHz
<b>Memory</b>	32GB DDR3 1600MHz
<b>GPU</b>	NVIDIA Kepler K40 GPUs, 2880 Cuda Cores, Memory 12GB
<b>OS</b>	Red Hat Enterprise Linux Server release 6.4
<b>Compiler</b>	PGI Compiler Accelerator Fortran/C/C++ 14 release 9 for Linux
<b>L2 Cache</b>	256K
<b>L3 Cache</b>	25MB

**Table 2.** Matrix size performance comparison.

Matrix size (N)	Implementation	Mean Running Time (Seconds)
2048	OpenMP with 20 Threads	26,578
	OpenACC	74,970
	OpenMPC	69,890
4096	OpenMP with 20 Threads	74,280
	OpenACC	92,320
	OpenMPC	75,120
8096	OpenMP with 20 Threads	116,23
	OpenACC	98,00
	OpenMPC	101,420
16192	OpenMP with 20 Threads	522,320
	OpenACC	190,230
	OpenMPC	222,320

## RESULT

The performance on the three frameworks (OpenMP v. 4, OpenACC, OpenMPC) presents a similar result on square matrices with size of 2048; however, if the size ingresses to 4096, the performance is little high on OpenACC implementation. With huge matrices greater than 12288, another factor as cache L2 and L3 has impact on process of data copy from host to device (Bader & Weidendorfer, 2009; Barragan & Steves, 2011; Gupta, Xiang, & Zhou, 2013). The performance of using a framework against using direct GPU CUDA languages, was just a bit (<5%), but the number of code lines was 70% minor. This shows that the framework offers useful programming tools with computational performance advantage; however, the performance gains on GPUs is on region of algorithms with high level of parallelism, and low data coupling with the host code (Dannert, Marek, & Rampp, 2013).

## CONCLUSION

The new devices for high performance computing need standardized methods and languages that permits interoperability, easy programming and well defined interfaces for integrating the data

interchange between memory segments of the processors (CPUs) and devices. Besides, it is necessary that languages have support for working with two or more devices on parallel using the same code but running segments of high parallelism in automatically form. OpenMP is the *de facto* standard for shared memory programming model, but the support for heterogeneous devices (Gpus, accelerators, fpga, etc.) is in very early stage, the new frameworks and industrial API need help for a growing and maturing standard.

## FINANCING

This research was developed with own resources, in the Doctoral thesis process at Universidad Distrital Francisco José de Caldas.

## FUTURE WORKS

It is necessary to analyze the impact of frameworks for multiple devices on the same host for management problems of memory locality, unified memory between CPU and devices and I/O operations from devices using the most recent version of its standard framework. With the support of GPUs device on the following version of GCC5, it is possible to obtain a compiler performance comparison between commercial and standards open source solutions. Furthermore, it's necessary to review the impact of using cluster with multi-devices, messaging pass and MPI integration for high performance computing using the language extensions (Schaa & Kaeli, 2009).

## ACKNOWLEDGMENT

We express our acknowledgment to director of high performance center of Universidad Industrial de Santander, the director of advanced computing center of Universidad Distrital and Pak Liu Technical responsible for application characterization, profiling and testing of HPC Advisor Council [www.hpcadvisorycouncil.com](http://www.hpcadvisorycouncil.com)



## REFERENCES

- Alsemmeri, M. (n.d.). CS 6260. Advanced Parallel Computations Course. Retrieved October 3, 2014, from <https://cs.wmich.edu/elise/courses/cs626/home.htm>
- Amorim, R. & Haase, G. (2009). Comparing CUDA and OpenGL implementations for a Jacobi iteration. ... & *Simulation*, 2009. ..., 22–32. doi:10.1109/HPCSIM.2009.5192847
- Bader, M. & Weidendorfer, J. (2009). Exploiting memory hierarchies in scientific computing. *2009 International Conference on High Performance Computing & Simulation*, 33–35. doi:10.1109/HPCSIM.2009.5192891
- Barragan, E. H. & Steves, J. J. (2011). Performance analysis on multicore system using PAPI. In *2011 6th Colombian Computing Congress (CCC)* (pp. 1–5). IEEE. doi:10.1109/COLOMCC.2011.5936277
- Dannert, T., Marek, A. & Rampp, M. (2013). Porting Large HPC Applications to GPU Clusters: The Codes GENE and VERTEX. Retrieved from <http://arxiv.org/abs/1310.1485v1>
- Dave, C., Bae, H., Min, S. & Lee, S. (2009). Cetus: A source-to-source compiler infrastructure for multicores. *Computer* (0429535). Retrieved from [http://ieeexplore.ieee.org/xpls/abs\\_all.jsp?arnumber=5353460](http://ieeexplore.ieee.org/xpls/abs_all.jsp?arnumber=5353460)
- Dongarra, J., Golub, G. H., Grosse, E., Moler, C. & Moore, K. (2008). Netlib and NA-Net: Building a Scientific Computing Community. *Annals of the History of Computing, IEEE*, 30(2), 30–41. doi:10.1109/MAHC.2008.29
- Durán, A. et al. (2008). Extending the OpenMP tasking model to allow dependent tasks. *Lecture Notes in Computer Science*, 5004, 111–122. doi:10.1007/978-3-540-79561-2\_10
- Fowers, J., Brown, G., Cooke, P., & Stitt, G. (2012). A performance and energy comparison of FPGAs, GPUs, and multicores for sliding-window applications. *Proceedings of the ACM/SIGDA ...*, 47. doi:10.1145/2145694.2145704
- Gravvanis, G. a., Filelis-Papadopoulos, C. K. & Lipitakis, E. a. (2013). On numerical modeling performance of generalized preconditioned methods. *Proceedings of the 6th Balkan Conference in Informatics on - BCI '13*, 23. doi:10.1145/2490257.2490266
- Gupta, S., Xiang, P. & Zhou, H. (2013). Analyzing locality of memory references in GPU architectures. ... of the *ACM SIGPLAN Workshop on Memory ...*, 1–2. doi:10.1145/2492408.2492423
- Hill, M. & Marty, M. (2008). Amdahl's law in the multicore era. *Computer*, 41(7), 33–38. doi:10.1109/MC.2008.209
- Huang, P., Teng, D., Wahid, K. & Ko, S.-B. (2009). Performance evaluation of hardware/software co-design of iterative methods of linear systems. *2009 3rd International Conference on Signals, Circuits and Systems (SCS)*, 1–5. doi:10.1109/ICSCS.2009.5414164
- Kim, Y. (2013). Performance tuning techniques for GPU and MIC. *2013 Programming weather, climate, and earth-system models on heterogeneous multi-core platforms*. Boulder, CO, National Oceanic and Atmospheric Administration.
- Lee, S. & Eigenmann, R. (2010). OpenMPC: Extended OpenMP programming and tuning for GPUs. *Proceedings of the 2010 ACM/IEEE International ...*, (November), 1–11. doi:10.1109/SC.2010.36
- Margaris, A., Souravlas, S. & Roumeliotis, M. (2014). Parallel Implementations of the Jacobi Linear Algebraic Systems Solve. *arXiv Preprint arXiv:1403.5805*, 161–172. Retrieved from <http://arxiv.org/abs/1403.5805>
- Meijerink, J. & Vorst, H. van der. (1977). An iterative solution method for linear systems of which the coefficient matrix is a symmetric -matrix. *Mathematics of Computation*, 31(137), 148–162. Retrieved from <http://www.ams.org/mcom/1977-31-137/S0025-5718-1977-0438681-4/>
- Nickolls, J. & Dally, W. (2010). The GPU computing era. *Micro, IEEE*, 30(2), 56–69. doi:10.1109/MM.2010.41
- OpenMP, A. (2013). *OpenMP application program interface, v. 4.0. OpenMP Architecture Review Board*. Retrieved from <http://scholar.google.com/scholar?hl=en&btnG=Search&q=intitle:OpenMP+Application+Program+Interface#1>

- Podobas, A., Brorsson, M. & Faxén, K. (2010). A comparison of some recent task-based parallel programming models, 1–14. Retrieved from <http://soda.swedish-ict.se/3869/>
- Reyes, R., López, I., Fumero, J. & Sande, F. De. (2012). A Comparative Study of OpenACC Implementations. *Jornadas Sarteco*. Retrieved from [http://www.jornadassarteco.org/js2012/papers/paper\\_150.pdf](http://www.jornadassarteco.org/js2012/papers/paper_150.pdf)
- Reyes, R. & López-Rodríguez, I. (2012). accULL: An OpenACC implementation with CUDA and OpenCL support. *Euro-Par 2012 Parallel ...*, 2(228398), 871–882. Retrieved from [http://link.springer.com/chapter/10.1007/978-3-642-32820-6\\_86](http://link.springer.com/chapter/10.1007/978-3-642-32820-6_86)
- Sanders, J. & Kandrot, E. (2011). CUDA by Example. *An Introduction to General-Purpose GPU Programming ...*. Retrieved from <http://scholar.google.com/scholar?hl=en&btnG=Search&q=intitle:CUDA+by+Example#1>
- Schaa, D. & Kaeli, D. (2009). Exploring the multiple-GPU design space. *2009 IEEE International Symposium on Parallel & Distributed Processing*, 1–12. doi:10.1109/IPDPS.2009.5161068
- Sun, X. & Gustafson, J. (1991). Toward a better parallel performance metric. *Parallel Computing*, 1093–1109. Retrieved from <http://www.sciencedirect.com/science/article/pii/S0167819105800286>
- Vetter, J. (2012). On the road to Exascale: lessons from contemporary scalable GPU systems. ... /A\* CRC Workshop on Accelerator Technologies for .... Retrieved from [http://www.acrc.a-star.edu.sg/astaratipreg\\_2012/Proceedings/Presentation - Jeffrey Vetter.pdf](http://www.acrc.a-star.edu.sg/astaratipreg_2012/Proceedings/Presentation - Jeffrey Vetter.pdf)
- Wang, Y. (n.d.). Jacobi iteration on GPU. Retrieved September 25, 2014, from [http://doubletony-pblog.azurewebsites.net/jacobi\\_gpu.html](http://doubletony-pblog.azurewebsites.net/jacobi_gpu.html)
- Wolfe, M. (2013). The OpenACC Application Programming Interface, 2.
- Zhang, Z., Miao, Q. & Wang, Y. (2009). CUDA-Based Jacobi's Iterative Method. *Computer Science-Technology and ...*, 259–262. doi:10.1109/IFCSTA.2009.68

## Integration model for health services in the colombian social security system

### Modelo de integración de servicios de salud del sistema de seguridad social colombiano

Lilia Edith Aparicio Pico\*, Pedro Arco Ríos\*\*, Alexandra López Sevillano\*\*\*

**Fecha de recepción:** June 10th, 2014

**Fecha de aceptación:** November 4th, 2014

**Citation / Para citar este artículo:** Aparicio Pico, L. E., Arco Ríos, P., & López Sevillano, A. (2014). Integration model for health services in the colombian social security system. *Revista Tecnura*, 18 (Edición especial doctorado), 171–182. doi: 10.14483/udistrital.jour.tecnura.2014.DSE1.a15

#### ABSTRACT

This article proposes an Integration Model for Health Services whose extent of complexity of care are included in the General System of Social Security in Health (SGSS) aimed at setting up a basic tool to enhance the effective and decisive response of the Colombian Healthcare System in the use and management of resources. The model allows carrying out an intrinsic assessment of the system administration, as well as of the resources and actors to be applicable to other integration systems and management of hospital resources at the national and international consensus. The analysis of complex systems is taken as fundamental issues to abstract the basic structure of interactions and assessment of possible emerging situations in the Management of Health System.

**Keywords:** Administration of Resources, Complex Systems, Components in Health, Health System, Integration in Health, Integration of Components, Integration Services Model, Management Model, System of General Social Security in Health.

#### RESUMEN

El artículo propone un Modelo de Integración de Servicios de Salud, cuyo grado de complejidad de atención están comprendidos en el Sistema General de Seguridad Social en Salud (SGSS), para instituir una herramienta básica que mejore la respuesta efectiva y resolutive del Sistema de Salud colombiano en la utilización y gestión de los recursos. El Modelo permite realizar una evaluación intrínseca de la administración del sistema, de los recursos y actores para ser aplicable a otros sistemas de integración y administración de los recursos hospitalarios en el consenso nacional e internacional. Se toman como aspectos fundamentales el análisis de los Sistemas Complejos para abstraer la estructura básica de interacciones y evaluación de posibles situaciones emergentes en la Gestión del Sistema de Salud.

**Palabras clave:** Administración de recursos, Sistemas complejos, Componentes en salud, Integración en salud, Integración de componentes, Modelo de integración de servicios, Modelo de gestión, Sistema General de Seguridad Social en Salud, Sistema en salud.

\* PhD. Lilia Edith Aparicio Pico, Electronic Engineering, PhD, professor, Universidad Distrital Francisco José de Caldas, Bogotá, Colombia, [medicina@udistrital.edu.co](mailto:medicina@udistrital.edu.co)

\*\* PhD. Pedro Arco Ríos, Electrical Engineer, PhD, professor, Universidad Central Marta Abreu De Las Villas, Habana, Cuba, [parco@uclv.edu.co](mailto:parco@uclv.edu.co)

\*\*\* Msc. Ing. Alexandra López Sevillano Software Engineer, Msc, Doctor's degree student in Engineering, Universidad Distrital Francisco José de Caldas, Bogotá, Colombia, [alelose@gmail.com](mailto:alelose@gmail.com)

## INTRODUCTION

In Latin America and the Caribbean there are marked concerns in health care (WHO, 2013). A set of components limit the access to a timely and quality health care, the lack of infrastructure resources, "is part of a series of studies of the regional program of social policies in Latin America" (SOPLA, 2012), equipping (technology), drugs, human talent and geographical distance, "Health and TIC" (CEPAL, 2012), including the public or private supply and the population demanding health care services.

Advances in the setting up of appropriate mechanisms for management among the main actors of a health system such as specialists, infrastructures and appropriate medical technologies and system users have been important in recent years. However, integration difficulties persist due to the multiplicity of factors and legal, economic, social frameworks which go even beyond the medical ethics.

The referents review highlights a good number of proposed solutions, such as the general structure model of the "information systems in hospital management", where essential components are grouped and monitored such as data information (information architecture), Hardware-Software-Networking (Technology Architecture), process-tasks-applications (domain architecture) and user management (Architecture Control); however, the component of quality of service delivery component is neglected and no direct correlation is set between the management of technology resources and its social impact (Joseph, 2001).

Another similar proposal is the strategy and architecture of the information system of medical care proposed by Bourke, where a management model of physical and human resources is depicted, but it fails to incorporate the element of information management.

More recent past history, as the case of the "medical information technology" journal: clinical

management and technology", approaches the issue of management models in health as a problem where obstacles in the human, technical and normative dimension shall be overcome (Rojas, 2009).

Several studies carried out in low-and middle income countries have shown that integrated systems in health services reduce the fragmentation of caregiving, avoiding the duplication of infrastructure and services, lowering the production and transaction costs, and they give a better response to health needs of the community (CEPAL, 2012).

Furthermore, it is mandatory to establish the cross-sectorial approach and relationships between components by measuring the effective and decisive response through indicators resulting in knowledge levels as proposed by Figuerola, where the processes and procedures of the organization (including standards, policies, templates, plans) and the corporate basis of knowledge that is the "knowledge management" which organizes, stores and shares vital information, so that everyone can be benefited from its use. Therefore, the structural and functional presentation of relationships among data, information, knowledge and wisdom must be seen from producers and consumers (Figuerola, 2013).

Another approach to the management of resources and services is that addressed in the data fusion model established by the Data Fusion Group, known as JDL where the development of information systems of multiple profitable sources requires a standard method for specifying the processing functions of data and control fusion, interfaces and associated databases (Blasch et al., 2006)

The proposal herein set forth has its central axis in the design of an integration model of health resources and services to contribute to the reduction of production costs, effectiveness of services, timeliness in service supply, real-time availability and occupancy rates. Similarly, lesser unnecessary hospitalizations, in the excessive use of diagnostic testing and services, decreases in the time of

hospital stay; involving own technological breakthroughs of scale economies and joint production “in pursuit of increased production volumes and productivity of the system”, as it is presented in the Reorganization, Redesign and Network Modernization in Delivery of Health Services Program (SDS, 2013).

The management and clinical technology of today strongly appear the computer tools based on GRD: plan, measure, evaluate and compare focused on cost control and performance evaluation in Health in a comparative manner, delivering performance and efficiency indicators (Emilio, 2014).

Therefore it was considered relevant within the proposal, to develop simulation scenarios for the scalable health model under an approach of integration of services and levels.

## FUNDAMENTALS, METHODS AND TECHNIQUES FOR THE MODEL DEVELOPMENT

### Interoperability

Decision 2004/387 / CE of the European Parliament and of the Council on the inter-operating provision of Electronic Management Services to the Public Sector, Business and Citizens (IDABC). This document defines the interoperability as “the ability of Information Technology Services and Communication (TICs) and business processes they support and exchange data and enable the sharing of information and knowledge”, as well as the definition first used in the document (DO387, 2004). As a case of study of the Desert Storm, by Sterling D. Sessions and Carl R. Jones, of the National Defense University, Washington DC, and added to the document AAP-6 NATO as an official definition. “The ability of systems, units or forces to provide services and accept services from other systems, units or forces and to use the exchanged services to operate effectively” (AAP-6.1993). The interoperability of processes is one of the fundamental pillars of a

management process, and it becomes an indicator of the performance of a whole management system. This indicator is embedded and optimized in part generating implementation guides. Often the “out-of-the-box” standards are abstract and flexible, so that a message or document complying with the standard does not necessarily suit a particular purpose. The implementation guide should include specific requirements or purposes, expression of restrictions, detail of vocabularies, references to standards (of HL7 or others), examples (fragments and entire documents), textual expression (Word or PDF document) and actionable (schematron or style sheet). (HL7 Argentina, 2012).

As examples of implementation guidelines in Spanish are those of SACYL, of Spain; that of the Hospital Italiano de Buenos Aires, Argentina; that of SUEIIDISS, of Uruguay, and HL7 Spain, of Spain; and IHE XDS-I, for radiology; the PCC, for continuity of clinical care, and the XDS-LAB, for laboratory. (HL7 Argentina, 2012).

What to order from systems providers? A statement of compatibility with standards and specific scenarios, through implementation guides: what messages or types of documents are exchanged and at what time? A good example of industry consensus to this regard are the IHE profiles that combine HL7, DICOM standards and its own adaptations to carry the standards to the level of process. The specification of vocabulary and cross-mapping of support for each item of coded data, depending on the application context, which can be expanded over time (from in-hospital to regional interoperability). These requirements for adaptation and cross-mapping of vocabularies can be increased. For instance, support for LOINC for LIS vendors; SNOMED-CT support for LIS vendors for pathology Anatomy; ICD10-ICD9- SNOMED-CT support for EHR systems. Accompany us in the growth of interoperability with the necessary flexibility to start with the exchange of documents or messages with a format, but with the awareness of being enabled to evolve to a higher level of interoperability over time. Finally, the compliance with the security



and privacy standards as defined by the local regulations. (Regulations, 2010).

In the field of standardization there is HL7 International, which provides a comprehensive framework for the exchange, integration, and retrieval of electronic health information that supports the clinical practice and the management and assessment of health services. It is the standard for the exchange of clinical documents instead of messages. Their latest release is the 2005 Regulation, CDA R2; while the CDA R3 is under discussion (no ballot). ARDEN SYNTAX / GELLO: for the exchange of clinical rules. CCOW: for the integration of applications at the desktop level. It allows an application vendor to integrate its HIS product with a RIS with another vendor transparently to the user, sharing the context on the desktop, at the level of user ID, patient who is being consulted and up to the study or examined report. (Regulations, 2005).

### Sources of Development

JavaSIG is the library that is best suited to implement the messages because, through a previous investigation, it is tailored to the particular needs of this project. JavaSIG is an Open Source implementation of the HL7 RIM classes using Java technology. Grails Framework Open Source oriented to an agile development process. It bears the paradigm of "coding by convention" to the Groovy language and it is oriented to the development of web 2.0 applications. It is based on frameworks and Java technologies like Spring, Groovy, Hibernate, Site Mesh, Quartz Scheduling, Jetty, HSQLDB, among others. Groovy is the Java's dynamic language; it presents a dynamic extension to the Java language, providing all the features of Java API plus new builders and features such as closures (a construction of functional programming). Furthermore, Groovy is compiled to byte code which is not a big performance problem. The Web Services E1 AXIS2 plugin for GRAILS to expose web services easily on the PIX Manager component; in turn, for

the consumption on the PID component. Apache Service Mix is an ESB Open Source developed by the Apache foundation which complies with JSR 208 specification for JBI. It also features a Normalized Message Router (NMR), as required by the JBI specification. Mirth is an ESB independent Open Source of platform, oriented to HL7 messaging. The transmission occurs through defined channels through a graphical interface. These channels operate with input and output connectors, filters and transformers. Currently supported connectors are: LLP, database, JMS, Web services SOAP, File, PDF, FTP, and SFTP. Through the graphical interface, it is possible to select which filters and transformations are applied to the incoming message before sending it to the output (HL7 Argentina, 2012).

### Information System

An Information System is a set of strategies that enable to carry out an efficient management of processes in an organization. "A group of people, data, processes and information technology that interact to collect, process, store and provide the information necessary for the proper functioning of the organization." (Whitten, Bentley & Dittman, 2004). HLT is specifically involved in creating standards, guidelines and flexible and cost-effective methodologies that enable the interoperability among the information systems and exchange of electronic health records.

Since 1994 the organization started to be accredited as SDO (Standards Developing Organization) by the ANSI (American National Standards Institute). As organization, HL7 has a formal structure and procedures based on the pursue of consensus and the balance of interests among the various sectors represented: software companies, funders of health, national states, universities, health care providers, consultants, etc.

The early versions of the messaging standard 1.0 and 2.0 were adopted in 1987 and 1988 respectively. Since then, these

were the succession of approved standards:  
Approved standards:

**Table 1.** Messengers standard

1990	1994	1997	1999	2000	2003	2007	2008
2.1	2.2	2.3	2.3.1	2.4	2.5	2.6	2.7

**Source:** HL7 Manual (2013).

## Architecture

Centralized and distributed architecture is defined, and the distributed computing has been designed to solve too big problems for any supercomputer and mainframe. Thus, grid computing is naturally a multiuser environment; therefore, the secure authorization techniques are essential. The centralized architecture provides the computational power and an incredible internal storage. The disadvantage of this architecture is that it lacks self-contained computer processors (Tanenbaum, 2006).

In Architecture of Next Generation Networks NGN, it is proposed as a project within the International Telecommunication Union in 2002, seeking to carry out the concepts defined for the Global Information Infrastructure, the first recommendations on NGN: the Y.2001 (ITU, 2004) and Y.2011 (ITU, 2006), which generally define the Architecture of Next Generation Networks and its characteristics. Much of the work of conceptualization within the ITU was based on the initial approaches made by the European Telecommunications Standards Institute (ITU-T, 2011).

In works carried out by ETSI and ITU, the points and interconnection interfaces are generally identified which should be available in the next generation network, highlighting the functional separation of the network in plans (Strata) of Transportation (Infrastructure) and services.

- User Network Interface (UNI - User Network Interface): Through which the functions of end users to NGN are interconnected.

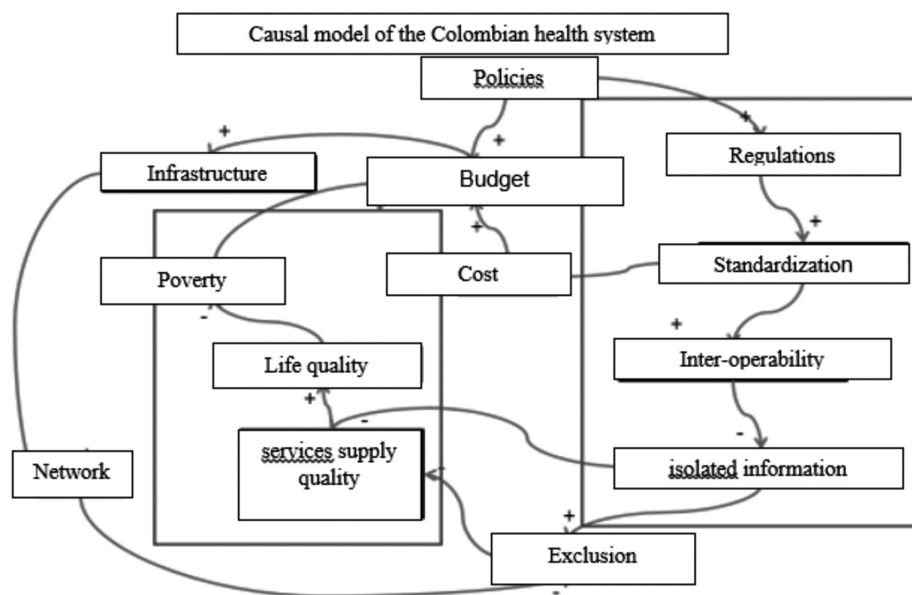
- Network - Network Interface (NNI - Network to Network Interface): Through which a network is connected to another (different domains).

- Application Interfaces – Network (ANI - Application to Network Interface): Through which they are connected to providers of third party applications.

## Clinical management

It increases the efficiency and quality of health care benefits provided by the health care units. "The best use of human, professional, technological and organizational resources for the best patient care." (Merced, 2007). The clinical management model used is that of Joseph, where the essential components such as data information (information architecture), Hardware-Software-Networking (Architecture of technology), process-tasks-applications (domain architecture) and user management (Control of architecture) is the general structure of information systems for health management (Joseph, 2001) and complemented with which we will define the clinical management model that will be developed and on which we have been working so-far using the framework of causal model system (See Figure 1).

It is started with the causal model as it allows to state that health problems must include the dialectical relationship between chance and necessity, between casual and causal versus the determinism and the mechanism prevailing in the analysis of health science. It is relevant to keep in mind that there is a consideration to that there is determination in indetermination and indetermination in determination.



**Figure 1.** Causal Model representing the Colombian health system components

Source: Own work.

## Causal Model

It is framed within the setting of statistical causal inference, based on the estimate of the causal effect on Medicine (Christakis & Iwashyna, 2003, Hirano & Imbens, 2001), epidemiology (Oakes & Church, 2007).

Experimental data in principle, if the assignment to treatment is at random, the causal inference is simple, since the two groups have been drawn from the same population, and by the treatment construction and assignment it is independent from all reference variables. In an experimental setup, something can go wrong. What does the statistical adjustment require? (Barnard, Frangakis, Colina, & Rubin, 2003).

When the compliance problem has a more complicated structure, it is difficult to move forward without making structural assumptions and statistical corrections for the compliance (Green & Gerber 2008).

One of the assumptions that the at random allocation by itself is not justifiable is that "observation in a unit should not be affected by the particular

assignment of treatments to the other units" (Cox, 1958). Rubin (1978) refers to this case as "no interference between units."

Observational data in a framework of observation, unless something special is done, the treatment groups and untreated groups are almost never balanced because the two groups do not originate from the same population (Rosenbaum & Rubin, 1983).

## Complex Systems

Complex systems will be used as they consist of several interconnected or interlinked parts whose ties produce non-visible additional information that makes it easier to accurately analyze the system. Complex systems have more information than that given by each independent part.

Several philosophers like Hesse (1963) and Hughes (1997) have studied the traditional scientific methodology and they have proposed the same general outline as the modeling process. According to these authors, scientists models are built to develop inference processes on certain aspects

of previously observed actual systems. It is through these inference processes, that the construction and use of scientific models enhances the understanding of observed real systems.

A system can be defined as “a set of elements in interaction” (Bertalanffy, 1968). Complex systems (i.e. multicellular organisms, ant colonies, ecosystems, economies, societies...) are characterized by having a structure composed of several levels, in these complex systems (Vicsek, 2002, Gilbert, 2004).

When there is one or more intermediate layers between the real system and our formal model, the modeling basic sequence is substantially modified (Edmonds et al., 2001; Galan et al., 2008). Regardless of the nature or complexity of the real system, to explain each stage in the modeling process of complex systems we find it useful to distinguish three roles (Drogoul et al., 2003): expert, modeler and ruler.

### Agent-based Simulation

The agent-based simulation has proven to be an extremely useful technique for modeling complex systems, and especially social systems (Conte et al., 1997, Gilbert & Troitzsch, 1999; Gilbert & Terna, 2000, Gilbert, 2007). Through agent-based simulation, the modeler explicitly recognizes that complex systems, and in particular the social system, are the outcome of individual behaviors and of their interactions.

The agent-based systems are characterized by comprising multiple agents which are to a larger or lesser extent autonomous, heterogeneous and independent, each showing their own goals and objectives, which generally are able to interact with each other and with their environment (Torusun, 1995).

The agent-based simulation has been widely used to model systems in a wide range of scientific disciplines, i.e. Economics (Tesfatsion, 2002, 2003), Finance (LeBaron, 2000), Natural Resource Management and Ecology (Bousquet & Le Page,

2004; Lopez & Hernandez, 2008), Political Science (Axelrod, 1997b; Johnson, 1999), Anthropology (Kohler & Gumerman, 2000), Sociology (Comte et al., 1997 Gilbert & Troitzsch, 1999; Gilbert, 2007), Biology (Paton et al., 2004; Walker et al., 2004a; Walker et al., 2004b) or Medicine (Mansury et al., 2002; Mansury & Deisboeck, 2004), in which starting from rules determining the agents individual behavior, it is intended to infer the global properties of the whole system (Holland, 1998).

### System Dynamics

The systems dynamics is another technique for modeling complex systems. It is also widely used for modeling systems in engineering (Ford, 1997; Ford & Sterman, 1998), Economics and Business (Sterman, 2000; Ellis, 2007), Planning and Project Management (Rodrigues & Bowers, 1996; Lyneis & Ford, 2007), Environmental Management (Martínez & Esteve, 2007), Public Health (Homer & Hirsch, 2006) and even History (Cruz, 2007). Unlike the agent-based simulation, the philosophy of system dynamics deals on the concept of feedback or circular causality between observable variables. These observables can describe some attributes of the basic components of the system. System dynamics studies observable variables of complex systems and attempts to identify the causality relationships (usually circular) existing among them. Once such relationships are identified, it is easier to explain the origin of the system global behavior from their causal structure.

### METHODOLOGIES

The following is an explanation of the elements referred to the processes of the health services integration model to be developed.

The data types will be quantitative and qualitative for the variables of standardization, interoperability, infrastructure, networks and service delivery quality components, in an effort to categorize each variable. This study uses the following three data



gathering techniques: Observation, semi-structured interviews and the documents review or analysis.

Accordingly the Rubin Causal Model (RCM) is proposed, cases of observational and experimental studies of causal inference and estimation by matching methods (Rubin, 2006). In order to identify, analyze and set the relations between the components the following is provided: Experimental data, observation of data and the matching method, the most common method of multivariate game based on the Mahalanobis distance (Cochran & Rubin 1973; Rubin 1979, 1980), where the framework of potential exits of Neyman is based on the potential exits, and the allocation mechanism where each component has a different exit potential according to a given conditional assignment. Indicators as variables that attempt to measure or objectify quantitatively or qualitatively collective events (especially events bio demographic) are identified, so as to backup political actions, evaluate achievements and goals. WHO (2000) has defined them as "variables used to measure changes." Health indicators often used in various combinations, are used in particular to assess the effectiveness and effects. Surveys will be carried out using sampling techniques (population surveys) and data from other sectors (economic, political and social welfare). The method is quantitative and qualitative. Donabedian (2001) was the first to propose that the methods for assessing the quality of health care can be applied to three basic elements of the system: structure, process and outcomes. This approach is kept to monitor the quality of health and hospital care.

For quality and usefulness of an indicator it is primarily defined by the following criteria:

- Validity (if it actually measures what it intends to measure).
- Reliability (if its repeated measurement under similar conditions produces the same results).
- Specificity (to measure only the phenomenon to be measured).
- Sensitivity (that can measure changes in the phenomenon to be measured).

- Measurability (that is based on data available or easy to obtain).
- Relevance (able to give clear answers to the most important issues of health policies).
- Cost-effectiveness (that results justify the investment in time and other resources).
- It is used for the developing of simulations, the modeling of complex systems through agent-based simulation and systems dynamics. Basically, a system can be defined as "a set of interacting elements" (Bertalanffy, 1968). Complex systems (i.e. multicellular organisms, ant colonies, ecosystems, economies, societies...) are characterized by having a structure composed by several levels. In these complex systems (Vicsek, 2002, Gilbert, 2004):
  - The components of lower hierarchical levels usually show a significant degree of autonomy.
  - The behavior of the system arises from the self-organization of its components, without this organization is controlled or directed by any agent out of the system.
  - The basic components of these complex systems (cells, ants, individuals, populations, businesses...) perceive their environment and respond to changes in it in potentially differently ways.
  - Many complex systems are also adaptive. In these adaptive systems (organisms, ecosystems, economies, societies...), the behavior of the basic components of the system may evolve over time, resulting in some capacity to respond to changes in the environment through mechanisms:
    - Learning at the individual level, and/or
    - Selection and Replacement (which results in a population-based learning).

The inference resulting from running a computer model has the following forms: The results obtained when running the computerized simulation are derived by deduction; therefore, using the logical need to apply algorithmic rules which define the model to the set of initial conditions with which the model has been parameterized. Thus, regardless of their larger or lesser degree of internal complexity, a computerized simulation is



a perfectly valid sufficiency theorem (see, for example, Axtell, 2000).

The agent-based simulation has proven to be a useful technique for modeling complex systems and more specifically the social systems (Conte et al., 1997; Gilbert & Troitzsch, 1999; Gilbert & Terna, 2000; Gilbert, 2007). Through the agent-based simulation, the modeler explicitly recognizes that complex systems and particularly the social systems are the result of individual behaviors of their interactions. What distinguishes the agent-based simulation from other modeling techniques is the way the first abstraction of the real system is built and consequently the formal model.

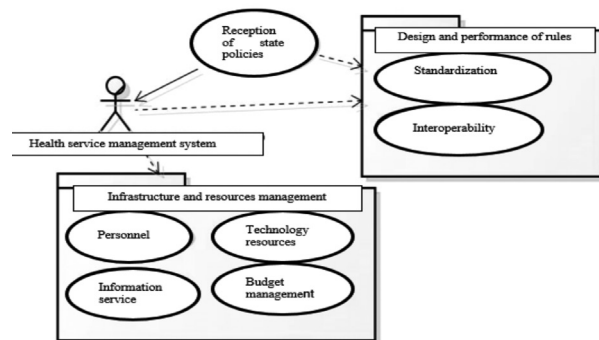
## EXPECTED RESULTS

It is expected to test an integration of health services model, which supported via software applications allows the optimization of human resources, technology, financial resources allocation, acquisition and processing of information from the various health centers and/or hospitals, clinics that make up the health services in the Capital District.

It is foreseen this approach will lead to a substantial improvement in primary care of patients, having access to basic information and medical history as well as the resources available for their care throughout the network, through the management of relational databases that will be supported through mechanisms of cloud computing. For the different health care facilities, and/or hospitals, clinics that are networked, the Integration System will allow the real-time access to each patient information and of the available resources and interactions among them all. The system modeling backed up by TICs seeks to speed up the entry and recognition process of the patients' specific characteristics through infrastructures of biometric identification such as fingerprints or the recognition of iris patterns.

The UML language is used for the model (Unified Modeling Language) (Engels, 2000); for the

application of user interfaces (Lopez, Espejo & Drake, 2004) and databases: Visual Net and MySQL as a valid tool to test the modeling through UML (Parra, Ruiz & Paz, 2005). The cases of Use are carried out for conventional and alternative scenarios to a priori assess the behavior that application may adopt to be developed as the Integration System of Health Services support. Subsequently, the class diagrams are proposed, specifying therein the variables, their types and operations on them. Finally, the sequence diagram is established to see how all the patient information, resources and underlying interoperability in each process is displayed (protocols of a patient's admission or triage, resources allocation, critical paths of processes, among others) who arrive at any health care facilities and/or hospitals, or clinics in the network.



**Figure 2.** Integration Model for the Distribution Network

**Source:** Own work.

For testing the verification of the application, the algorithmic complexity is assessed based on the criteria of the system response-time in the light of nominal scenarios or usual sequence (Perez, Orejas & Fuentes, 2005), alarm generation in non-conformity scenarios or faults such as the non-previously validated users access into the system and the capacity of memory used on the machines where the application is running. For the case of using the integration system of health services, see Figure 2.

## CONCLUSIONS

This project draws a solution from the information technology standpoint to the integration of services issues to comprehensively care for health, the fragmentation of processes, mitigate the scarce prevention, the disruption of related bodies and agencies and other collateral issues.

Regarding the project scientific and technological impacts on the participating institutions, the development of technical knowledge is relevant to contribute to the appropriation of international best practices in the managing the Life Cycle of applications, their implementation and use.

Impacts on productivity and competitiveness of the beneficiary entity to the related sector will be transformed into a competitive and nationally well-known sector as it will be integrated into its services the use of technology, communications and service delivery being one of the first to provide with the above mentioned components, the implementation of the project and will position us nationally as a pioneer in health innovation, which in turn reinforces the credibility and confidence of the sector entities and will open the possibility of offering this service to other regions at national and international levels.

The impact on the population/territorial area in epidemiological terms where the platform can generate analysis information to generate early warnings about epidemiological phenomena will be another asset. In socio – economic terms, the project implementation will allow to reduce the training times, so as to increase productivity in integration between the different health entities. Moreover it will be sought to reduce the patients care costs per patient for both the institutions and patients themselves, and thus achieving the optimization of financial, technological and professional resources.

## REFERENCES

- Axelrod, R. (1997a). "Advancing the Art of Simulation in the Social Sciences". En Conte R, Hegselmann, R. & Terna, P. (Eds.) *Simulating Social Phenomena, Lecture Notes in Economics and Mathematical Systems* 456: 21-40.
- Berlin: Springer-Verlag. (1997b). *The complexity of cooperation: Agent based models of competition and collaboration*. Princeton NJ: Princeton University Press.
- Bertalanffy, L. (1968). "General System Theory". New York: George Braziller Publisher.
- Bousquet, F. & Le page, C. (2004). "Multi-agent simulations and ecosystem management: A review". *Ecological Modelling*, 176(3-4), 313-332.
- Comisión Económica para América Latina (CEPAL, 2012). "Equipamiento y tecnología".
- Comisión Europea (2009a). "Directrices comunitarias para la aplicación de las normas sobre ayudas estatales al despliegue rápido de redes de banda ancha". *Diario Oficial de la Unión Europea*, 2009/C 235/04.
- Comisión Europea (2009b). "Movilizar las inversiones públicas y privadas con vistas a la recuperación y el cambio estructural a largo plazo": *Desarrollo de la colaboración público-privada (CPP)*.
- Cox, D. R. (1958). *Planning of Experiments*. New York: Wiley.
- Cruz, M. M. (2007). "Evaluando la dinámica de sistemas como una herramienta para enseñar Historia". *Revista de Dinámica de Sistemas*, 3(2), 3-60.
- Drogoul, A., Vanbergue, D. & Meurisse, T. (2003). "Multi-Agent Based Simulation: Where are the Agents". En Sichman, J. S., Bousquet, F. & Davidsson, P. (Eds.), *Lecture Notes in Computer Science* 2581. *Proceedings of MABS 2002 Multi-Agent- Based Simulation*, 1-15. Bologna, Italy: Springer-Verlag.
- Edmonds, B., Moss, S. & Davidsson, P. (2001). "The Use of Models - Making MABS actually work". In *Multi-Agent-Based Simulation, Lecture Notes in Artificial Intelligence* 1979, 15-32. Berlin: Springer-Verlag.
- Engels, G. (2000). "UML- A Universal Language?". *ICATPN 2000, LNCS 1825*, Berlin, Heidelberg, Springer-Verlag.
- Figueroa, N. (2013). *Gestión del conocimiento (Knowledge Management) Pirámide D-I-K-W*.

- Ford, A. (1997). "System dynamics and the electric power industry". *System Dynamics Review*, 13(1), 57-85.
- Ford, D. N. & Sterman, J. D. (1998). "Dynamic modeling of product development
- Gilbert, N. (2004). "Agent-based social simulation Dealing with complexity". Centre for Research on Social Simulation, University of Surrey. (2007). "Agent-Based Models. Quantitative Applications in the Social Sciences". London: SAGE Publications.
- Green, D., & Gerber, A. (2008). "Field Experiments and Natural Experiments." In Janet M. Box-Steffensmeier, Henry E. Brady, and David Collier (Eds), *The Oxford Handbook of Political Methodology*, New York: Oxford University Press.
- Hesse, M. B. (1963). *Models and Analogies in Science*. London: Sheed and Ward.
- HL7 Argentina. (2012). "13° Edición Curso Virtual HL7 Introducción a los estándares HL7 V2.x, V3 y CDA orientados al intercambio de información entre sistemas de salud".
- Holland, J. H. (1998). "Emergence. From chaos to order. Reading, MA": Addison-Wesley.
- Holt, L. & Jamison, M. (2009). "Broadband and contributions to economic growth": Lessons from the US experience, *Telecommunications Policy*, 33, 575-581.
- Hughes, R. G. (1997). "Models and Representation". *Philosophy of Science*, 64(4), S325-S336.
- ITU. (2004). General overview of NGN. ITU-T. Recommendation.Y. 2001.
- ITU. (2004). General Principals and general reference model for Next Generation Networks. ITU-T. Recommendation.Y. 2001.
- ITU. (2006). Requisitos y arquitectura funcional de las redes de la próxima generación, versión 1. ITU-T. Recommendation.Y. 2011.
- K. H. Tan, J. (2001). *Health Management Information Systems*. Editorial Services: Joan Sesma.
- Kohler, T. & Gumerman, G. J. (2000). "Dynamics in human and primate societies: Agent-based modeling of social and spatial processes". New York: Oxford University Press & Santa Fe Institute.
- Lebaron, B. (2000). "Agent Based Computational Finance: Suggested Readings and Early Research". *Journal of Economic Dynamics & Control*, 24(5-7), 679-702.
- López Paredes, A. & Hernández Iglesias, C. (2008). *Agent Based Modelling in Natural Resource Management*. Insisoc. España. ISBN 978-84-205-4560-8.
- López, P. et al. (2004)
- Lyneis, J. M. & Ford, D. N. (2007). "System dynamics applied to project management: A survey, assessment, and directions for future research". *System Dynamics Review*, 23(2-3), 157-189.
- Mansury, Y. & Deisboeck, T. S. (2004). "Simulating the time series of a selected gene expression profile in an agent-based tumor model". *Physica D: Nonlinear Phenomena* 196(1-2), 193-204.
- Mansury, Y., Kimura, M., Lobo, J. & Deisboeck, T. S. (2002). "Emerging Patterns in Tumor Systems: Simulating the Dynamics of Multicellular Clusters with an Agent-Based Spatial Agglomeration Model". *Journal of Theoretical Biology*, 219(3), 343-370.
- Normativa (2005). "HL7 CDA R2-Documentos clínicos".
- Normativa (2010). "HL7 V3- Mensajería a nivel regional".
- Organización Panamericana de la Salud/Organización Mundial de la Salud (OPS/OMS, 2013). "Modelo de salud".
- Paton, R. et al. (2004): "Evolvable social agents for bacterial systems modeling". *IEEE Transactions on Nanobioscience*, 3(3), 208-216.
- Programa Regional Políticas Sociales en América Latina (SOPLA, 2012). "Forma parte de una serie de estudios del programa regional de políticas sociales de América Latina".
- Rosenbaum, P. R. and Rubin, D. B. (1983). "The Central Role of the Propensity Score in Observational Studies for Causal Effects." *Biometrika*, 70(1), 41-55.
- Rubin, D. B. (1978). "Bayesian Inference for Causal Effects: The Role of Randomization." *Annals of Statistics*, 6(1): 34-58.
- Rubin, D. B. (1979). "Using Multivariate Sampling and Regression Adjustment to Control Bias in Observational Studies". *Journal of the American Statistical Association*, 74, 318-328.

- Rubin, D. B. (1980). "Bias Reduction Using Mahalanobis-Metric Matching." *Biometrics*, 36(2), 293-298.
- Secretaría Distrital de Salud (2013). "Programa de Reorganización, Rediseño y Modernización de Redes de Prestación de Servicios de Salud".
- Sterman, J. D. (2000). *Business Dynamics: Systems thinking and modeling for a complex world*. McGraw-Hill.
- Tesfatsion, L. (2002). "Agent-based computational economics: Growing economies from the bottom up". *Artificial life*, 8(1), 55-82.
- Tesfatsion, L. (2003). "Agent-based computational economics: Modeling economies as complex adaptive systems". *Information Sciences*, 149(4), 263-269.
- Torsun, I. S. (1995). *Foundations of Intelligent Knowledge-based Systems*. New York: Academic Press.
- Vicsek, T. (2002). "Complexity: The bigger picture". *Nature*, 418(6894), 131.
- Whitten, J., Bentley, L.D & Dittman, K.C. (2004). *Systems analysis & design methods*. Citado por Fernández Vicencç, 2006: Desarrollo de sistemas de información: Una metodología basada en el modelado".

# INSTRUCCIONES PARA LOS AUTORES

## Revista *TECNURA* Universidad Distrital Francisco José de Caldas Facultad Tecnológica

### CONTENIDO

- Alcance y política editorial de la revista
- Tipos de artículos aceptados
- Formato del artículo
- Envío de artículos
- Procedimiento para la publicación
- Arbitraje de artículos
- Contacto

### 1. ALCANCE Y POLÍTICA EDITORIAL DE LA REVISTA

La revista *Tecnura* es una publicación institucional de la Facultad Tecnológica de la Universidad Francisco José de Caldas, de carácter científico-tecnológico con periodicidad trimestral, que se publica los meses de enero, abril, julio y octubre. Su primer número apareció en el segundo semestre del año 1997 y hasta la fecha ha mantenido su regularidad.

Las áreas temáticas de interés de la revista *Tecnura* están enfocadas a todos los campos de la ingeniería, como la electrónica, telecomunicaciones, electricidad, sistemas, industrial, mecánica, catastral, civil, ambiental, entre otras. Sin embargo, no se restringe únicamente a estas, también tienen cabida los temas de educación y salud, siempre y cuando estén relacionados con la ingeniería. La revista publica únicamente artículos de investigación científica y tecnológica, de reflexión y de revisión. En consecuencia, durante la fase de evaluación editorial inicial se rechazarán los artículos cortos y reportes de caso.

La revista *Tecnura* está dirigida a docentes, investigadores, estudiantes y profesionales interesados en la actualización permanente de sus conocimientos y el seguimiento de los procesos de investigación científico-tecnológica, en el campo de las ingenierías. Tiene como misión divulgar resultados de proyectos de investigación realizados en el área de las ingenierías, a través de la publicación de artículos originales e inéditos, realizados por académicos y profesionales pertenecientes a instituciones nacionales o extranjeras del orden público o privado. Los artículos presentados deben ser trabajos inéditos escritos en español o inglés; sin embargo, tendrán preferencia los artículos que muestren conceptos innovadores de gran interés, que traten sobre asuntos relacionados con el objetivo y cobertura temática de la revista.

*Tecnura* es una publicación de carácter académico indexada en el Índice Bibliográfico Nacional Publindex (IBN) de Colciencias (Colombia) en la categoría A2, en los Índices Regionales Scielo Colombia (Colombia) y Redalyc (México), además de las siguientes bases bibliográficas: INSPEC del Institution of Engineering and Technology (Inglaterra), Fuente Académica Premier de EBSCO (Estados Unidos), CABI (Inglaterra), Index Copernicus (Polonia), Informe Académico de Gale Cengage Learning (México), Periódica de la Universidad Nacional Autónoma de México (México), Oceanet (España) y Dialnet de la Universidad de la Rioja (España). También hace parte de los siguientes directorios: Sistema Regional de Información en Línea para Revistas Científicas de América Latina, el Caribe, España y Portugal Latindex (México), Índice Bibliográfico Actualidad Iberoamericana (Chile),



e-Revistas (España), DOAJ (Suecia), Ulrich de Proquest (Estados Unidos) y CABI (Reino Unido)

*Tecnura* es una revista arbitrada mediante un proceso de revisión entre pares de doble ciego. La periodicidad de la conformación de sus comités Científico y Editorial está sujeta a la publicación de artículos en revistas indexadas internacionalmente por parte de sus respectivos miembros.

La Universidad Distrital Francisco José de Caldas, sus directivas, el Editor, el Comité Editorial y Científico no son responsables por la opinión y criterios expresados en el contenido de los artículos y estos se publican bajo la exclusiva responsabilidad de los autores y no necesariamente reflejan el pensamiento del Comité Editorial.

Además de la versión impresa, la revista *Tecnura* tiene también una versión digital disponible en su página web: <http://revistas.udistrital.edu.co/ojs/index.php/Tecnura>

## 2. TIPOS DE ARTÍCULOS ACEPTADOS

De acuerdo con la clasificación del Índice Nacional de Publicaciones Científicas y Tecnológicas (Publindex-Colciencias), la revista *Tecnura* recibe postulaciones de artículos inéditos de los siguientes tipos:

- **Artículos de investigación científica y tecnológica:** documento que presenta, de manera detallada, los resultados originales de proyectos de investigación. La estructura generalmente utilizada contiene cuatro apartes importantes: introducción, metodología, resultados y conclusiones.
- **Artículos de reflexión:** documento que presenta resultados de investigación desde una perspectiva analítica, interpretativa o crítica del autor, sobre un tema específico y recurriendo a fuentes originales.
- **Artículo de revisión:** documento resultado de una investigación donde se analizan, sistematizan e integran los resultados de las investigaciones publicadas o no publicadas, sobre un campo en ciencia o tecnología, con el fin de dar cuenta de los avances y las tendencias de desarrollo. Se caracteriza por presentar una cuidadosa revisión bibliográfica de al menos 50 referencias.

## 3. FORMATO DEL ARTÍCULO

### 3.1 Del lenguaje y estilo apropiado para la redacción de artículos

- Deben emplearse estructuras de oraciones simples, evitando las que sean demasiado largas o complejas.
- El vocabulario empleado debe ser básico y común. Los términos técnicos deben explicarse brevemente; asimismo, el significado de las siglas debe presentarse la primera vez que estas aparecen en el texto.
- Los autores son responsables de que su trabajo sea conducido de una manera profesional y ética.

### 3.2 De la extensión de los documentos

Los artículos no deben tener una extensión de más de 25 páginas en tamaño carta y a doble espacio, con márgenes simétricas de 3 cm. Solo en el caso de los artículos de revisión las 25 páginas no incluyen las referencias bibliográficas.

### 3.3 Del formato de presentación

Los artículos presentados deben ser trabajos inéditos escritos en español o inglés y deben digitalizarse en Microsoft Word (2003 en adelante), cumpliendo con las siguientes indicaciones:

- Letra *Times New Roman* de 12 puntos (a excepción de que se requiera lo contrario para algunos apartados).
- Una columna a doble espacio.
- Todas las márgenes de 3 cm.
- Los párrafos se justifican, y no debe haber espacio entre los consecutivos.
- No incluir saltos de página o finales de sección.
- Si se desea resaltar palabras o frases del texto, no usar letra negrita sino letra cursiva.
- Los decimales se deben señalar con coma (,) y no con un punto.
- Los millares y millones se deben señalar con un espacio fino.

- Evitar las notas de pie de página.
- Se debe utilizar nomenclatura arábica hasta el tercer nivel únicamente.

### 3.4 De la estructura del documento

Los trabajos deben tener la siguiente estructura y cumplir con los siguientes requisitos:

#### *Composición de un artículo*

Todos los artículos remitidos para su evaluación y posible publicación por parte de la revista *Tecnura* deben tener por lo menos los siguientes componentes:

- Título en español e inglés.
- Información de los autores.
- Resumen en español e inglés.
- Palabras clave en español e inglés.
- Introducción.
- Conclusiones.
- Trabajo futuro (opcional).
- Agradecimientos (opcional).
- Referencias bibliográficas.

Si el artículo es de investigación científica y tecnológica deben tener, además de lo anterior, los siguientes componentes:

- Metodología.
- Resultados.
- Financiamiento.

#### *Título*

El título del artículo deberá ser corto o dividido en título y subtítulo, atractivo para el lector potencial y escrito en mayúscula sostenida. Este debe aparecer centrado entre las márgenes, escrito con letra *Times New Roman*, en negrita, tamaño de fuente 18. El título del artículo debe ir en español e inglés separado por un espacio doble. Máximo 20 palabras.

#### *Autores*

Después del título debe escribirse el (los) nombre(s) completo(s) del (los) autor(es), acompañado de los datos biográficos básicos: título de pregrado, título de posgrado, ocupación o cargo, afiliación institucional (institución donde labora), dependencia, ciudad, país y correo electrónico. La información anterior debe ir inmediatamente debajo del nombre del autor.

#### *Resumen*

Debe establecer el objetivo y alcance del trabajo, una descripción clara y concisa de la metodología, los resultados y las conclusiones obtenidas. Máximo 250 palabras.

#### *Palabras clave*

Debe escogerse entre tres y diez palabras clave, escritas en español con letra *Times New Roman*, en negrita y cursiva.

Las palabras clave deben estar escritas en orden alfabético y ser de uso estandarizado, para lo cual se sugiere utilizar bases de datos internacionales según el área del conocimiento. Por ejemplo, en el área de Eléctrica y Electrónica se sugiere utilizar el tesoro de la UNESCO que se pueden encontrar en la página: <http://databases.unesco.org/thessp>.

#### *Abstract*

Debe ser una traducción correcta y precisa al idioma inglés del texto que aparece en el resumen en español.

#### *Keywords*

Debe ser una traducción correcta y precisa al idioma inglés de la lista de palabras clave en español.

Las *keywords* deben estar escritas en el orden de las palabras clave y ser de uso estandarizado, para lo cual se sugiere utilizar bases de datos internacionales según el área del conocimiento. Por ejemplo, en el área de Eléctrica y Electrónica se sugiere utilizar los Tesoros de la IEEE y/o World Bank que se pueden encontrar en las siguientes páginas respectivamente: [http://www.ieee.org/documents/2009Taxonomy\\_v101.pdf](http://www.ieee.org/documents/2009Taxonomy_v101.pdf), <http://multites.net/mtsqr/wb/site/default.asp>

### *Introducción*

Debe describir el planteamiento general del trabajo, así como contexto, antecedentes, estado de arte de la temática abordada, objetivo y posible alcance del trabajo.

### *Metodología*

La redacción de este apartado debe permitir a cualquier profesional especializado en el tema replicar la investigación.

### *Resultados*

Explicación e interpretación de los hallazgos. Si es necesario, se puede presentar una discusión breve y enfocada a la interpretación de los resultados.

### *Conclusiones*

Implicación de los resultados y su relación con el objetivo propuesto.

### *Financiamiento*

Mencionar la investigación asociada de la cual se derivó el artículo y la entidad que avaló y financió dicha investigación.

### *Agradecimientos*

Preferiblemente deben ser breves y deben incluir los aportes esenciales para el desarrollo del trabajo.

### *Ecuaciones*

Deben aparecer centradas con respecto al texto principal. Las ecuaciones deben ser referenciadas con números consecutivos (escritos entre paréntesis cerca al margen derecho). Las ecuaciones se citan en el texto principal empleando la palabra ecuación y seguida del número entre paréntesis. Las ecuaciones deben ser elaboradas en un editor de ecuaciones apropiado y compatible con el paquete de software InDesign, por ejemplo, el editor de ecuaciones de Windows.

### *Tablas*

Para el caso de realización de tablas se recomienda que estas no sean insertadas como imágenes,

considerando que en este formato no pueden ser modificadas. El encabezado de cada tabla debe incluir la palabra Tabla (en negrita) seguida del número consecutivo correspondiente y de un breve nombre de la tabla. El encabezado debe estar escrito con letra Times New Roman, en cursiva y tamaño de fuente 9.

No se presentan cuadros sino tablas y estas se deben levantar automáticamente desde el procesador de textos. Las tablas deben ir nombradas y referenciadas en el artículo, en estricto orden. Toda tabla debe tener en su parte inferior la fuente de la que fue tomada, o mencionar que es autoría de los autores si es el caso.

### *Figuras*

Todas las figuras o fotografías deben enviarse en formato PNG o TIFF con una resolución mínima de 300 DPI, adaptadas a escala de grises.

El pie o rótulo de cada figura debe incluir la palabra Figura (en negrita) seguida del número consecutivo correspondiente y de una breve descripción del contenido de la figura. El pie de figura debe estar escrito con letra *Times New Roman*, en cursiva y tamaño de fuente 9. Las figuras deben ir nombradas y referenciadas en el artículo, en estricto orden. Toda figura debe tener también la fuente de la que fue tomada, o mencionar que es autoría de los autores si es el caso.

### *Símbolos*

Los símbolos de las constantes, variables y funciones en letras latinas o griegas –incluidos en las ecuaciones– deben ir en cursiva; los símbolos matemáticos y los números no van en cursiva. Se deben identificar los símbolos inmediatamente después de la ecuación. Se deben utilizar las unidades, dimensiones y símbolos del sistema internacional.

Cuando se empleen siglas o abreviaturas, se debe anotar primero la equivalencia completa, seguida de la sigla o abreviatura correspondiente entre paréntesis y en lo subsecuente se escribe solo la sigla o abreviatura respectiva.

### Referencias bibliográficas

El estilo de citación de referencias adoptado por la revista **Tecnura** es APA sexta edición. Las citas, referencias bibliográficas e infografía se incluyen al final del artículo. Las referencias bibliográficas deben ordenarse alfabéticamente de acuerdo con el primer apellido del primer autor, sin numeración.

Solo deben aparecer las referencias que fueron citadas en el texto principal del trabajo, en las tablas o en las figuras. Es decir, en la lista no deben aparecer otras referencias aunque hayan sido consultadas por los autores para la preparación del trabajo. Sugerimos utilizar herramientas como: *Citas y bibliografía* de Microsoft Word (para APA sexta edición versión 2013 o superior), *Zotero*, *Mendeley*, entre otras.

El llamado de una referencia bibliográfica se inserta en el texto, en el punto pertinente, bajo ciertas características:

- Si la oración incluye el apellido del autor, solo se debe escribir la fecha dentro de un paréntesis, ejemplo:

*Cuando Vasco (2012), analizó el problema de presentado en ....*

- Cuando no se incluye el autor en la oración, debe ir entre el paréntesis el apellido y la fecha.

La investigación de materiales dio una visión en el área (Martínez, 2012).

- Si el documento u obra tiene más de dos autores, se debe citar la primera vez con todos los apellidos.

1990. (Fernández Morales, Villa Krieg & Caro de Villa, 2008) ....

- En las menciones siguientes, solo se debe escribir el primer apellido del autor, seguido de un "et al".

En cuanto al estudio de las aguas, Fernández Morales et al. (2008) encontraron que ...

- Cuando el documento u obra tiene más de seis autores, se debe utilizar desde la primera mención el "et al".

A continuación se describen una serie de ejemplos de las referencias más utilizadas, según

el estilo de referencias adoptado por la revista *Tecnura*:

### Publicaciones Periódicas:

Forma Básica

Apellidos, A. A., Apellidos, B. B. & Apellidos, C. C. (Fecha). Título del artículo. *Título de la publicación*, volumen (número), pp. xx-xx. doi: xx.xxxxxxx

### *Artículo básico*

Guevara López, P., Valdez Martínez, J., Agudelo González, J., & Delgado Reyes, G. (2014). Aproximación numérica del modelo epidemiológico SI para la propagación de gusanos informáticos, simulación y análisis de su error. *Revista Tecnura*, 18(42), 12 -23. doi:http://dx.doi.org/10.14483/udistrital.jour.tecnura.2014.4.a01

### *Artículo web*

Rodríguez Páez, S., Fajardo Jaimes, A., & Páez Rueda, C. (2014). Híbrido rat-race miniaturizado para la banda ISM 2,4 GHz. *Revista Tecnura*, 18(42), 38-52. Recuperado de <http://revistas.udistrital.edu.co/ojs/index.php/Tecnura/article/view/8059/9675>

### Libros:

Forma Básica

Apellidos, A. A. (Año). *Título*. Ciudad: Editorial.

Apellidos, A. A. (Año). *Título*. Recuperado de <http://www.xxxxxx.xxx>

Apellidos, A. A. (Año). *Título*. doi: xx.xxxxxxxx

Apellidos, A. A. (Ed.). (Año). *Título*. Ciudad: Editorial.

### *Libro con autor*

Goleman, D. (2000). *La inteligencia emocional: Por qué es más importante que el cociente intelectual*. México: Ediciones B.

### *Libro con editor:*

Castillo Ortiz, A. M. (Ed.). (2000). *Administración educativa: Técnicas, estrategias y prácticas gerenciales*. San Juan: Publicaciones Puertorriqueñas

**Libro versión electrónica:**

Montero, M. & Sonn, C. C. (Eds.). (2009). *Psychology of Liberation: Theory and applications*. [Versión de Springer]. doi: 10.1007/978-0-387-85784-8

**Informe técnico:****Forma Básica**

Apellidos, A. A. (Año). *Título*. (Informe Núm. xxx). Ciudad: Editorial

**Informe con autores**

Weaver, P. L., & Schwagerl, J. J. (2009). *U. S. Fish and Wildlife Service refuges and other nearby reserves in Southwestern Puerto Rico*. (General Technical Report IITF-40). San Juan: International Institute of Tropical Forestry.

**Informe de una agencia del gobierno**

- Federal Interagency Forum on Child and Family Statistics. *America's Children: Key National Indicators of Well-Being, 2009*. Washington, DC: U.S. Government Printing Office. Recuperado de <http://www.childstats.gov/pubs/index.asp>

**Tesis****Forma Básica**

Apellidos, A. A. (Año). *Título*. (Tesis inédita de maestría o doctorado). Nombre de la institución, Localización.

**Tesis inédita, impresa**

Muñoz Castillo, L. (2004). *Determinación del conocimiento sobre inteligencia emocional que poseen los maestros y la importancia que le adscriben al concepto en el aprovechamiento de los estudiantes*. (Tesis inédita de maestría). Universidad Metropolitana, San Juan, PR.

**Tesis de base de datos comercial**

Santini Rivera, M. (1998). *The effects of various types of verbal feedback on the performance of selected motor development skills of adolescent males with Down syndrome*. (Tesis doctoral). Disponible

en la base de datos ProQuest Dissertations and Theses. (AAT 9832765).

**Tesis web**

Aquino Ríos, A. (2008). *Análisis en el desarrollo de los temas transversales en los currículos de español, matemáticas, ciencias y estudios sociales del Departamento de Educación*. (Tesis de maestría, Universidad Metropolitana). Recuperado de [http://suagm.edu/umet/biblioteca/UMTESIS/Tesis\\_Educacion/ARAquinoRios1512.pdf](http://suagm.edu/umet/biblioteca/UMTESIS/Tesis_Educacion/ARAquinoRios1512.pdf)

**Estándares o patentes****Forma Básica**

Apellidos, A. A. *Título de la patente*. País y número de la patente. Clasificación de la patente, fecha de concesión oficial. Número y fecha de solicitud de la patente, paginación.

Hernández Suárez, C. A., Gómez Saavedra, V. A., & Peña Lote, R. A. Equipo medidor de indicadores de calidad del servicio de energía eléctrica para usuario residencial. Colombia., 655. G4F 10/0, 15 de Marzo 2013. 27 de Octubre 2011, 147

**4. ENVÍO DE ARTÍCULOS**

Los autores deben enviar sus artículos a través de la aplicación para tal fin del Open Journal System en formato digital, adjuntando la carta de presentación y el formato de información artículo-autores.

**4.1 Carta de presentación**

El artículo debe ir acompañado de una carta de presentación dirigida al director y editor de la revista, Ing. Cesar Augusto García Ubaque, donde incluya:

- Solicitud expresa de considerar su artículo para publicarlo en la revista *Tecnura*.
- Título completo del trabajo.
- Nombres completos de todos los autores del trabajo.
- Certificación de la originalidad y el carácter inédito del trabajo.



- Exclusividad de su remisión a la revista *Tecnura*.
- Confirmación de la autoría con la firma de todos los autores.

Esta carta deberá estar firmada por todos los autores, escanearse y enviarse junto con los demás documentos solicitados.

#### 4.2 Formato de información artículo-autores

El artículo además debe ir acompañado de un formato de información sobre el artículo y sus autores, el cual se puede descargar de la página web de la revista *Tecnura*: <http://revistas.udistrital.edu.co/ojs/index.php/Tecnura>, en la sección "Formatos y Documentos". Es importante completar todos los campos de información solicitados, algunos de ellos tienen comentarios para aclarar mejor lo que se está solicitando. El formato no debe escanearse.

#### 4.3 Artículo

Artículo en formato digital (Word 2003 en adelante) que cumpla con todas las normas de presentación descritas en el capítulo 3, "Formato del artículo", de la presente en las instrucciones a los autores.

### 5. PROCEDIMIENTO PARA LA PUBLICACIÓN

El procedimiento que sigue la revista *Tecnura* para la evaluación y posible publicación de los trabajos enviados por los autores es el siguiente en orden cronológico:

1. Envío del artículo acompañado de la carta de presentación y el formato de información por parte de los autores.
2. Notificación al autor de correspondencia de la recepción del artículo.
3. Verificación del tema del artículo con respecto a las áreas de interés de la revista.
4. Verificación de las normas de presentación por parte del monitor de la revista.
5. Notificación al autor de correspondencia de la evaluación de las normas de presentación.

6. Envío de las correcciones realizadas por los autores con respecto a la evaluación de las normas de presentación.
7. Envío del artículo a los árbitros seleccionados.
8. Notificación del inicio del proceso de arbitraje del artículo.
9. Notificación a los autores de la decisión tomada por el Comité Editorial y de las evaluaciones hechas por los árbitros.
10. Envío de las correcciones realizadas por los autores con respecto a las evaluaciones de los árbitros.
11. Estudio de la versión final del artículo y de las evaluaciones de los árbitros por parte del Comité Editorial.
12. Envío por parte de los autores de la carta de cesión de derechos al editor de la revista.
13. Envío de la versión con corrección de estilo y diagramada a los autores.
14. Verificación de errores y aprobación final de la versión con corrección de estilo y diagramada por parte de los autores.
15. Publicación del artículo en el número correspondiente de la revista *Tecnura*.
16. Notificación a los autores de la publicación del número de interés.
17. Envío de un ejemplar de la revista a cada autor del artículo publicado.

### 6. PROCESO DE ARBITRAJE DE ARTÍCULOS

Considerando la periodicidad trimestral de la revista, el Comité Editorial realiza cuatro convocatorias anuales para la recepción de artículos, aproximadamente en los meses de febrero, mayo, agosto y noviembre. Los artículos serán recibidos hasta la fecha máxima establecida en cada convocatoria.

Una vez recibidos los artículos el monitor de la revista realizará una primera evaluación de forma para verificar que cumplan con todos los elementos mencionados en esta guía de instrucciones a los autores. Luego de recibir nuevamente el artículo con las correcciones de forma solicitadas por el

monitor de la revista, este será sometido a evaluación por tres pares académicos (paulatinamente se espera incorporar un mayor número de pares externos que participen en el proceso).

Cada artículo remitido a la revista *Tecnura* es revisado por dos pares académicos externos a la institución de los autores, mediante un proceso de “revisión entre pares” (*Peer-review*) de doble ciego, garantizando el anonimato de los autores y evaluadores; se considera confidencial todo trabajo recibido y así se le exige a sus evaluadores.

Las posibles conclusiones de los resultados de la evaluación por parte de los árbitros son únicamente tres: publicar el artículo sin modificaciones, publicar el artículo con modificaciones o no publicar el artículo.

Posteriormente, el Comité Editorial toma la decisión de publicar o no los artículos, con base en los resultados de las evaluaciones realizadas por los árbitros asignados. En caso de existir contradicciones en las evaluaciones con respecto a la publicación de un artículo, el Comité Editorial enviará el artículo a un tercer árbitro y se inclinará por las dos evaluaciones que tengan el mismo concepto respecto a la publicación del artículo.

En cada convocatoria el autor de correspondencia debe sugerir al menos cuatro posibles evaluadores externos a su institución laboral, los cuales deben ser especialistas en el tema específico del artículo remitido, tener al menos maestría y por lo menos dos deben ser internacionales. Los posibles evaluadores pueden pertenecer a una universidad o industria, pública o privada; de estos se debe proporcionar el nombre completo, su formación académica más alta, su afiliación institucional y su correo electrónico. Estos cuatro potenciales

evaluadores serán analizados por el Comité Editorial a fin de ampliar la base de datos de los árbitros de la revista *Tecnura*.

El Comité Editorial de la revista *Tecnura* se reserva los derechos de impresión, reproducción total o parcial del artículo, así como el de aceptarlo o rechazarlo. Igualmente, se reserva el derecho de hacer cualquier modificación editorial que estime conveniente; en tal caso el autor recibirá por escrito recomendaciones de los evaluadores. Si las acepta, deberá entregar el artículo con los ajustes sugeridos dentro de las fechas fijadas por la revista para garantizar su publicación dentro del número programado.

## 6. CONTACTO

Para cualquier solicitud de información adicional puede comunicarse a través del correo electrónico de la revista *Tecnura*: [tecnura@udistrital.edu.co](mailto:tecnura@udistrital.edu.co), [tecnura@gmail.com](mailto:tecnura@gmail.com), o por mensajería con el Ing. Cesar Augusto García Ubaque, Director y Editor de la revista *Tecnura*, a la dirección:

Revista *Tecnura*

Sala de Revistas, Bloque 5, Oficina 305.

Facultad Tecnológica

Universidad Distrital Francisco José de Caldas

Transversal 70 B N. 73 a 35 sur

Teléfono: 571 – 3238400 Extensión: 5003

Celular: 57–3153614852

Bogotá D.C., Colombia

Email: [tecnura@udistrital.edu.co](mailto:tecnura@udistrital.edu.co), [tecnura@gmail.com](mailto:tecnura@gmail.com)

Página web: <http://revistas.udistrital.edu.co/ojs/index.php/Tecnura>

## INSTRUCTIONS FOR AUTHORS

### *Tecnura journal* District francisco José de caldas university Faculty of technology

#### CONTENT

- **Scope and editorial policy of the journal**
- **Type of accepted articles**
- **Article format**
- **Article submission**
- **Publication procedure**
- **Arbitration of article process**
- **Contact**

#### 1, SCOPE AND EDITORIAL POLICY OF THE JOURNAL

*Tecnura journal* is an institutional publication of the Faculty of Technology from University Francisco José de Caldas. It is a scientific and technological publication with quarterly periodicity, which is published in January, April, July and October. The first issue appeared in the second semester of 1997 and up to now it has maintained its regularity.

The areas of interest of *Tecnura journal* are focused on all engineering fields such as electronics, telecommunications, electricity, systems, industrial, mechanics, cadastral, civil, environmental, among others. However, it is not restricted to those; it also has room for education and health issues, as long as they are related to engineering. The journal will only publish concerning scientific and technological research, reflection and revision. In consequence, during the initial editorial evaluation, short articles and case reports will be rejected.

*Tecnura Journal* is addressed for professors, researchers, students and professionals interested in permanent update of their knowledge and follow-up of scientific-technologic processes in the field of engineering. *Tecnura Journal* has as mission to disseminate results of research projects in

the areas of engineering, through the publication of original and unpublished articles, conducted by academics and professionals accredited by public or private national or foreign institutions. Articles submitted to *Tecnura journal* must be unpublished works written in Spanish or English; nevertheless, preference will be given to articles that show innovative concepts of great interest, related to the objective and scope of the journal.

*Tecnura* is an academic publication indexed in the Índice Bibliográfico Nacional Publindex (IBN) from Colciencias (Colombia) at the category A2, in the Regional Index Scielo Colombia (Colombia) and Redalyc (México); as well as of the following bibliographic databases: INSPEC of the Institution of Engineering and Technology (England), Fuente Académica Premier of EBSCO (United States), CABI (England), Index Copernicus (Poland), Informe Académico of Gale Cengage Learning (México), Periódica from the Universidad Nacional Autónoma de México (México), Oceanet (Spain) and Dialnet from the Universidad de la Rioja (Spain). It is also part of the following directories: Online Regional Information System for Scientific journals from Latin America, Caribbean, Spain and Portugal Latindex (México), Bibliographic Index Actualidad Iberoamericana (Chile), e-Revistas (Spain), DOAJ (Sweden) and Ulrich of Proquest (United States).

*Tecnura* is a journal arbitrated by a revision process among double blind peers. The schedule of the conformation of its scientific and editorial committee is subject to the publication of articles in internationally indexed journals by their members.

District University Francisco José de Caldas, its directors, the editor, the editorial and scientific committee are not responsible for the opinions and the criteria expressed in the content of the articles

and they are published under the exclusive responsibility of the authors and do not necessarily reflect the ideas of the editorial committee.

In addition to the printed version, Tecnura journal also has a digital version available in its web page: <http://revistas.udistrital.edu.co/ojs/index.php/Tecnura/index>

## 2. TYPE OF ARTICLES ACCEPTED

According to the classification of the Scientific and Technological Publications National Index (Publindex-Colciencias), *Tecnura* journal receives nominations of unpublished articles on the following topics:

- ***Scientific and technological research articles:*** document that presents, in a detailed manner, the original results of research projects. The generally used structure contains four main parts: introduction, methodology, results and conclusions.
- ***Reflection articles:*** document that presents research results from an analytic, interpretative or critic perspective from the author, dealing with a specific topic and adopting original sources.
- ***Review article:*** document that results from a research where the results of published or unpublished research on a science or technology field are analyzed, systematized and integrated, in order to state the advances and tendencies in development. It is characterized for presenting a careful bibliographical review of at least 50 references.

## 3. ARTICLE FORMAT

### 3.1 About the appropriate language and style for articles writing

- Authors must use simple sentence structures, avoiding those too long or complex.
- The vocabulary used must be basic and common. Technical language must be briefly explained; also, the meaning of the acronyms must be given the first time they appear in the text.
- The authors are responsible for their work to be conducted in a professional and ethic manner.

### 3.2 About the length of articles

The articles should not exceed 25 pages in letter size and double space, with symmetric margins of 3 cm. Only in the case of review articles, these 25 pages do not include references.

### 3.3 About the presentation format

Submitted articles must be unpublished works written in Spanish or English, and must be typed in Microsoft Word (2003 and beyond), complying with the following indications:

- *Times New Roman* letter, 12 point (except it is required for some sections).
- One column, double-spaced.
- All the margins 3 cm.
- Paragraphs should be justified without spaces between consecutives and without cutting words.
- Do not include page breaks or section finals.
- If you want to emphasize words or phrases from the text, do not use bold letters but italic.
- Decimals should be pointed with comma (,) and not with period (.).
- Thousands and millions should be pointed with a fine space.
- Avoid footnotes.
- Arabic nomenclature must be used only until the third level.

### 3.4 About the article structure

The papers must have the following structure and comply with the following requirements:

#### Composition of an article

All the articles submitted for evaluation and possible publication by the Tecnura Journal must have at least the following components:

- Title in Spanish and English.
- Information about the authors.

- Abstract in Spanish and English.
- Key words in Spanish and English.
- Introduction.
- Conclusions.
- Future work (optional).
- Acknowledgements (optional).
- Bibliographical references.

If the article is related to scientific and technological research must have, in addition to the above, the following components:

- Methodology.
- Results.
- Financing.

### *Title*

The title of the article must be short or divided in title and subtitle, attractive for the potential reader and written in capital letters. It should appear centered between the margins, written in *Times New Roman* letter, in bold, font size 18. The title of the article has to be in Spanish and English separated by double space. Maximum 20 words.

### *Authors*

After the title the complete name(s) of the author(s) must be written, with their basic biographical data: undergraduate degree, graduate degree, occupation or position, institutional affiliation (institution where they work), dependency, city, country and e-mail. The above information must be immediately below the author's name.

### *Abstract*

The scope and purpose of the work must be established giving a clear and concise description of the methodology, results presented and the conclusions obtained. Maximum of 250 words.

### *Keywords*

Between three and ten keywords must be chosen, written in English with *Times New Roman* letter in bold and italic.

Key words must be written in alphabetic order and must be as standard as possible, for which it is suggested the use of international databases according to the area of knowledge. For example, in the area of Electrics and Electronics it is suggested to use the IEEE thesaurus and World Bank thesaurus that can be accessed at the following web pages respectively:

[http://www.ieee.org/documents/2009Taxonomy\\_v101.pdf](http://www.ieee.org/documents/2009Taxonomy_v101.pdf),

<http://multites.net/mtsql/wb/site/default.asp>

### *Abstract in Spanish*

Translation to the Spanish language of the text that appears in the abstract, it must be correct and precise.

### *Keywords in Spanish*

Translation to the English language of the keywords in Spanish, they must be correct and precise.

Keywords must be written in the order of the English version and must be as standard as possible, for which it is suggested the use of international databases according to the area of knowledge. For example, in the area of Electrics and Electronics it is suggested to use the UNESCO thesaurus that can be found at the following web pages: <http://databases.unesco.org/thessp>

### *Introduction*

The general idea of the work must be described, its context, backgrounds, state of the art of the topic, objectives and possible scope of the work.

### *Methodology*

The writing of this part must allow any specialized professional in the topic to replicate the research.

### *Results*

Explanation and interpretation of the findings. If necessary, a brief discussion focused on the interpretation of the results can be presented.



### *Conclusions*

Implication of the results and their relation to the proposed objective.

### *Financing*

Mention the associated research from which the article was derived and the entity that endorsed and financed the research.

### *Acknowledgments*

They should preferably be brief and include the essential contributions for the development of the paper.

### *Equations*

Equations must appear centered with respect to the main text. They must be referenced with consecutive numbers (written in parenthesis close to the right margin). Equations are cited in the main text employing the word equation, and followed by the number in parenthesis. Equations must be made in an appropriate equation editor and compatible with "InDesign" software, as for example the equation editor of Windows.

### *Tables*

In the case of implementation of tables, it is recommended that these are not inserted as images, considering that in that format they cannot be modified. The title of each table must include the word table (in italic) followed by the corresponding consecutive number and a brief name of the table. The heading must be written in TNR letter, italic and font size 9.

Charts are not presented but tables and they should be automatically raised from the text processor. Tables should be named and referenced in the article, in strict order. Every table must have at the bottom the source from which it was taken, or to mention self-authorship if it is the case.

### *Figures*

All the figures or pictures have to be sent in JPG or PNG format with a minimum resolution of 300 DPI, adapted to gray scale.

The footnote or name of each figure must include the word figure (in italic) followed by the corresponding consecutive number and a brief description of the content of the figure. The footnote of the figure must be written in *Times New Roman* letter, italic and font size 9. Figures must be named and referenced in the article, in strict order. Every figure must have at the bottom the source from which it was taken, or to mention self-authorship if it is the case.

### *Symbols*

The symbols of the constants, variables and functions in Latin or Greek letters –included in the equations- must be in italic; the mathematical symbols and the numbers do not go in italic. The symbols must be identified immediately after the equation. Units, dimensions and symbols of the international system must be used

When using acronyms or abbreviations, the complete equivalence should be written first, followed by the corresponding acronym or abbreviation in parenthesis and from there it is only written the respective acronym or abbreviation.

### *Bibliographic references*

The adopted reference citation style by *Tecnura* journal is APA sixth edition. The cites, bibliographic references and infography are included in the last part of the article. The bibliographic references must be alphabetically ordered according to the author's first surname, without numbering.

There should only appear the cited references in the main body of the work, in tables or in figures. It means, in the list there should not appear other references although they have been consulted by the authors for the work preparation. We suggest using tools such as: Cites and bibliography from Microsoft Word (for APA sixth edition version 2013 or superior), Zotero, Mendeley, among others.

The call for a bibliographic reference is inserted in the text, at the pertinent point, under certain characteristics:

- If the sentence includes the author's surname, it should only be written the date into a parenthesis, for instance:

*Cuando Vasco (2012), analizó el problema de presentado en ....*

- When the author is not included in the sentence, surname and date must be into a parenthesis.

*La investigación de materiales dio una visión en el área (Martínez, 2012).*

- If the document or work has more than two authors, the first cite must include all the surnames. *1990. (Fernández Morales, Villa Krieg & Caro de Villa, 2008) ....*

- In the following mentions, it must only be written the author's first surname, followed by "et al.".

*En cuanto al estudio de las aguas, Fernández Morales et al. (2008) encontraron que ...*

- When the document or work has more than six authors, it must be used from the first mention "et al.".

Next it is described a series of examples of the more used references, according to the reference style adopted by *Tecnura* journal:

### **Periodical Publications:**

Basic Form

Surnames, A. A., Surnames, B. B. & Surnames, C. C. (Date). Article's title. *Title of the publication*, volume (number), pp. xx-xx. doi: xx.xxxxxxx

### **Basic article**

Guevara López, P., Valdez Martínez, J., Agudelo González, J., & Delgado Reyes, G. (2014). Aproximación numérica del modelo epidemiológico SI para la propagación de gusanos informáticos, simulación y análisis de su error. *Revista Tecnura*, 18(42), 12 -23. doi:http://dx.doi.org/10.14483/udistrital.jour.tecnura.2014.4.a01

### **Web article**

Rodríguez Páez, S., Fajardo Jaimes, A., & Páez Rueda, C. (2014). Híbrido rat-race miniaturizado

para la banda ISM 2,4 GHZ. *Revista Tecnura*, 18(42), 38-52. Recuperado de <http://revistas.udistrital.edu.co/ojs/index.php/Tecnura/article/view/8059/9675>

### **Books:**

Basic Form

Surnames, A. A. (Year). *Title*. City: Editorial.

Surnames, A. A. (Year). *Title*. Recovered from <http://www.xxxxxx.xxx>

Surnames, A. A. (Year). *Title*. doi: xx.xxxxxxx

Surnames, A. A. (Ed.). (Year). *Title*. City: Editorial.

### **Book with author**

Goleman, D. (2000). *La inteligencia emocional: Por qué es más importante que el cociente intelectual*. México: Ediciones B.

### **Book with editor:**

Castillo Ortiz, A. M. (Ed.). (2000). *Administración educativa: Técnicas, estrategias y prácticas gerenciales*. San Juan: Publicaciones Puertorriqueñas

### **Book electronic version:**

Montero, M. & Sonn, C. C. (Eds.). (2009). *Psychology of Liberation: Theory and applications*. [Versión de Springer]. doi: 10.1007/ 978-0-387-85784-8

### **Technical report:**

Basic Form

Surnames, A. A. (Year). *Title*. (Report No. xxx). City: Editorial

### **Report with authors**

Weaver, P. L., & Schwagerl, J. J. (2009). *U. S. Fish and Wildlife Service refuges and other nearby reserves in Southwestern Puerto Rico*. (General Technical Report IITF-40). San Juan: International Institute of Tropical Forestry.

### **Report from a Government agency**

Federal Interagency Forum on Child and Family Statistics. *America's Children: Key National Indicators of Well-Being, 2009*. Washington, DC: U.S. Government Printing Office. Recuperado de <http://www.childstats.gov/pubs/index.asp>

**Thesis****Basic form**

Surnames, A. A. (Year). Title. (Unpublished master or doctorate thesis). Institution name, Location.

***Unpublished thesis, printed***

Muñoz Castillo, L. (2004). *Determinación del conocimiento sobre inteligencia emocional que poseen los maestros y la importancia que le adscriben al concepto en el aprovechamiento de los estudiantes*. (Tesis inédita de maestría). Universidad Metropolitana, San Juan, PR.

***Commercial database thesis***

Santini Rivera, M. (1998). *The effects of various types of verbal feedback on the performance of selected motor development skills of adolescent males with Down syndrome*. (Tesis doctoral). Disponible en la base de datos ProQuest Dissertations and Theses. (AAT 9832765).

***Web thesis***

Aquino Ríos, A. (2008). *Análisis en el desarrollo de los temas transversales en los currículos de español, matemáticas, ciencias y estudios sociales del Departamento de Educación*. (Tesis de maestría, Universidad Metropolitana). Recuperado de [http://suagm.edu/umet/biblioteca/UMTESIS/Tesis\\_Educacion/ARAquinoRios1512.pdf](http://suagm.edu/umet/biblioteca/UMTESIS/Tesis_Educacion/ARAquinoRios1512.pdf)

**Standards or patents****Basic form**

Surnames, A. A. Title of the patent. Country and number of the patente. Classification of the patent, date of official license. Number and date of patent request, pagination.

Hernández Suárez, C. A., Gómez Saavedra, V. A., & Peña Lote, R. A. Equipo medidor de indicadores de calidad del servicio de energía eléctrica para usuario residencial. Colombia., 655. G4F 10/0, 15 de Marzo 2013. 27 de Octubre 2011, 147

**4. ARTICLE SUBMISSION**

Authors must submit their articles through the application Open Journal System in digital format, attaching the cover letter and the article-authors format.

**4.1 Cover letter**

The article must be submitted with a cover letter addressed to the director and editor of the journal, Engineer Cesar Augusto Garcia Ubaque, including:

- Specific request to consider your article to be published in Tecnura journal.
- Full title of the article.
- Full names of all the authors of the paper.
- Certification of the originality and unpublished character of the paper.
- Exclusivity of submission to Tecnura journal.
- Authoring confirmation with signature of all the authors.

This letter must be signed by all the authors, scanned and sent with the remaining requested documents.

**4.2 Article-authors information format**

The article has to be submitted with an information format about the article and its authors which can be downloaded from the web page of Tecnura journal <http://revistas.udistrital.edu.co/ojs/index.php/Tecnura/index>, in the section "Forms and Documents". It is important to complete all the fields of information requested, some of them have comments to clarify better what is being requested. The format must not be scanned.

**4.3 Article**

Article in digital format (Word 2003 and later editions) that complies with all the presentation rules described in chapter three, "Article structure", of this guide of instructions for authors.

## 5. PUBLICATION PROCEDURE

The procedure to be followed by Tecnura journal for the evaluation and possible publication of the papers sent by the authors is the following in chronological order:

1. Delivery of the article with the cover letter and the information format by the authors.
2. Notification to the author about the reception of the article.
3. Verification of the presentation rules by the monitor of the journal.
4. Notification to the author about the evaluation of the presentation rules.
5. Submission of corrections made by the authors related to the evaluation of presentation rules.
6. Submission of the articles to the selected arbitrators.
7. Notification of the beginning of the arbitration process of the article.
8. Notification to the authors about the decision made by the editorial committee, and about the evaluations made by the arbitrators.
9. Delivery of the corrections made by the authors with respect to the evaluations made by the arbitrators.
10. Study of the final version of the article and the evaluations of the arbitrators by the editorial committee.
11. Delivery by the authors of the letter that surrenders right to the editor of the journal.
12. Submission of the version with style corrections and diagrammed to the authors.
13. Verification of errors and final approval of the version with style corrections and diagrammed by the authors.
14. Publication of the article in the corresponding number of Tecnura journal.
15. Notification to the authors of the number of interest.
16. Delivery of a copy of the journal to each one of the authors of the published article.

## 6. ARTICLE ARBITRATION PROCESS

Considering the quarterly periodicity of the journal, the Editorial Committee makes four calls every year for the submission of articles, approximately in the months of February, May, August and November. The articles will be received until the date established in the call.

Once received the articles, the monitor of the journal will make an initial form evaluation to verify the completion of the elements mentioned in this guide of instructions to authors. After receiving again the article with the requested corrections by the journal's monitor, the paper will be submitted to evaluation by three academic peers (through time it is expected to include more external peers to participate in the process).

Each article sent to Tecnura journal is checked by two expert academic peers external to the institution of the authors, by a process of "Peer-review" of double blind, guaranteeing the anonymity of authors and evaluators; every paper sent is considered confidential and so it is demanded to evaluators.

Possible conclusions of the result of the evaluation by the judges are only three: publish the article without modifications, publish the article with modifications and not publish the article.

Subsequently, the Editorial Committee takes the decision to publish or not the articles, based on the results of the evaluations made by the assigned arbitrators. In case of contradictions in the evaluations with respect to the publication of an article, the editorial committee will send the article to a third peer and will be inclined for the two evaluations that have the same concept with respect to the publication of the article.

In each call the main author must suggest at least four possible external arbitrators to his work institution evaluators, who must be specialists in the specific topic of the article sent and must have at least Masters level, and at least two must to be international. Potential evaluators can belong to a university or industry, public or private; their complete names must be provided, highest academic

formation, institutional affiliation and e-mail. The editorial committee will analyze these four potential evaluators in order to enrich the database of arbitrators of *Tecnura* journal.

The Editorial Committee of *Tecnura* journal reserves the right to print, reproduce total or partially the article, as the right to accept or reject it. In the same way, it has the right to make any editorial modification that considers necessary; in this case the author will receive written recommendations from the evaluators. If accepted, authors must deliver the article with the suggested adjustments within the dates given by the journal to guarantee its publication in the programmed number.

## CONTACT

For any additional information request, please send an e-mail to *Tecnura* journal [tecnura@udistrital.edu.co](mailto:tecnura@udistrital.edu.co).

[tecnura@gmail.com](mailto:tecnura@gmail.com) or by mail to Cesar Augusto Garcia Ubaque, Director and Publisher of *Tecnura* Journal, to the following address:

*Tecnura* Journal

Journals Room, Block 5, Office 305.

Faculty of Technology

Universidad Distrital Francisco José de Caldas

Transversal 70 B N. 73 a 35 sur

Phone: 571-3238400 Extension: 5003

Mobile: 57-3153614852

Bogotá D.C., Colombia

Email:

[tecnura@udistrital.edu.co](mailto:tecnura@udistrital.edu.co), [tecnura@gmail.com](mailto:tecnura@gmail.com)

Web page:

<http://revistas.udistrital.edu.co/ojs/index.php/Tecnura/index>

*Tecnura*/index





UNIVERSIDAD DISTRITAL  
FRANCISCO JOSÉ DE CALDAS

## SUSCRIPCIÓN

### Revista *Tecnura*

Nombre completo: \_\_\_\_\_

Institución u organización: \_\_\_\_\_

Factura a nombre de: \_\_\_\_\_

Dirección de envío: \_\_\_\_\_

Ciudad: \_\_\_\_\_ Departamento, Estado o provincia: \_\_\_\_\_

Código postal: \_\_\_\_\_ Apartado aéreo / P.O. Box: \_\_\_\_\_

País: \_\_\_\_\_ Correo electrónico: \_\_\_\_\_

Teléfono: \_\_\_\_\_ Fax: \_\_\_\_\_ Firma: \_\_\_\_\_

Tabla de costos de suscripción:

Región	1 Año	2 Años
Bogotá	40 000 COP	70 000 COP
Colombia	45 000 COP	80 000 COP
América Latina y el Caribe	40 USD	70 USD
Estados Unidos y Canadá	40 USD	70 USD
Otras regiones	60 USD	100 USD

**Nota:** los precios tanto en dólares como en pesos incluyen el valor del envío.

Diligenciar el formato de suscripción y enviarlo por correo junto con la copia del recibo de consignación a la dirección postal que aparece en el parte inferior de esta página o escaneado a los correos electrónicos [tecnura@udistrital.edu.co](mailto:tecnura@udistrital.edu.co) y [tecnura@gmail.com](mailto:tecnura@gmail.com). La consignación nacional se realiza en el Banco de Occidente a nombre de la Universidad Distrital Francisco José de Caldas en la cuenta de ahorros número 230-81461-8.

#### Canje y suscripciones

Enviar a Ing. César Augusto García Ubaque, PhD.  
Director y Editor Revista *Tecnura*

#### Biblioteca

Facultad Tecnológica  
Universidad Distrital Francisco José de Caldas  
Transversal 70B No. 73A - 35 sur  
Teléfono: +57 - 1 - 7311542  
Celular: +57 - 3153614852  
Bogotá, D.C., Colombia

Correo electrónico: [tecnura@udistrital.edu.co](mailto:tecnura@udistrital.edu.co) [tecnura@gmail.com](mailto:tecnura@gmail.com)

Tecnura en internet: <http://tecnura.udistrital.edu.co>



UNIVERSIDAD DISTRITAL  
FRANCISCO JOSÉ DE CALDAS

## SIGN UP

### *Tecnura journal*

Full name: \_\_\_\_\_  
Institution or organization: \_\_\_\_\_  
Invoice name: \_\_\_\_\_  
Mailing address/address: \_\_\_\_\_  
City: \_\_\_\_\_ Department, state or province: \_\_\_\_\_  
Zip code: \_\_\_\_\_ P.O. Box: \_\_\_\_\_  
Country: \_\_\_\_\_ E-mail: \_\_\_\_\_  
Phone number: \_\_\_\_\_ Fax: \_\_\_\_\_ Signature: \_\_\_\_\_

#### Table of subscription costs:

<b>Región</b>	<b>1 year</b>	<b>2 year</b>
Bogotá	23 USD	40 USD
Colombia	26 USD	46USD
Latin America and The Caribbean	40 USD	70 USD
The United States of America and Canada	40 USD	70 USD
Other regions	60 USD	100 USD

**Note:** prices in both dollars and pesos include the value of the shipment.

Fill out the subscription form and mail it along with a copy of the receipt of consignment to the e-mail address that appears in the bottom of this page or scanned to the following E-mails: [tecnura@udistrital.edu.co](mailto:tecnura@udistrital.edu.co) and [tecnura@gmail.com](mailto:tecnura@gmail.com). The national bank deposit is done in Banco de Occidente in the name of Universidad Distrital Francisco José de Caldas in the savings account number 230-81461-8.

#### **Exchange and Subscription**

Send Ing Cesar Augusto Garcia Ubaque PhD.  
Editor and Publisher Tecnura Journal

#### **Library**

Technology Faculty  
Universidad Distrital Francisco José de Caldas  
Transversal 73A No. 70B-35 Sur  
Phone: +57 - 1 - 7311542  
Mobile: +57-3153614852  
E-mail: [tecnura@udistrital.edu.co](mailto:tecnura@udistrital.edu.co), [tecnura@gmail.com](mailto:tecnura@gmail.com)